



Emser Tile®

Porcelain & Ceramic, Decorative and
Natural Stone Collections





ABOVE: Parkview™ Brown & White 23" x 47"
COVER: Livorno™ Elba 23" x 47"
BACK COVER: Vara™ Varzo 12" x 24"



TABLE OF CONTENTS

<i>The Emser Story</i>	2
<i>Floor Tile</i>	12
<i>Wall Tile</i>	212
<i>Decorative Tile</i>	284
<i>Natural Stone</i>	388
<i>Resources</i>	422

Since 1968

Established in 1968 and headquartered in Los Angeles, California, Emser Tile® is a leading designer, producer and marketer of the world's finest tile and natural stone. By offering unparalleled service and a vast selection of products, Emser Tile® is a comprehensive source for interior and exterior products that include porcelain, ceramic, glass, decorative accents, metal, quarry, mosaics, natural and engineered stone, cut-to-size products, setting materials and custom manufactured products made to your specifications. Our nationwide service network includes state of the art distribution centers and local sales and service locations to combine a strong national presence with tailored, local service. Building upon over 50 years of service, our dedication and commitment to our customers remains as strong as ever and is the core of our business and our culture.

Our services are tailored to customers' specific requirements. Emser Tile® offers exclusive programs that help retailers, home builders, commercial builders, contractors, architects and designers exceed their customers' expectations and requirements while keeping projects on schedule and within budget.

Our global network brings the latest trends, technologies and innovations for ceramic and porcelain tile, glass, natural stone, decorative, mosaic and metal products. We continue to offer the most compelling and extensive portfolio of colors, finishes, patterns and textures, accompanied by a broad assortment of coordinating trim and accent pieces.

Our expansive capacity translates into a vast selection of products and immediate distribution. With Emser Tile®, customers have quick access to unique and first-to-market products. With our local sales and service locations and global network of factory alliances, Emser Tile® has the infrastructure to logistically support any size project on a domestic or international level.







GREEN BUILDING INITIATIVE

At Emser Tile®, we embrace our responsibility to protect the planet and create sustainable processes in everything that we do. We hold the same standard for our suppliers and trade partners, and work alongside them to ensure that they adhere to maintaining and improving their standards. Emser Tile®'s Green Building Initiative features a systematic three-prong approach:

- Implementing company-wide environmentally conscious practices in the workplace at all Emser locations throughout North America, including distribution centers. This is a combined effort also shared by our trade partners.
- Practicing transparency of raw materials sourcing with our suppliers, so that we know exactly what ingredients are going into the products we sell down to 1000ppm.
- Educating employees and customers alike through internal and external training programs such as CEU/CES classes regarding health, safety and welfare standards related to material sourcing, manufacturing and installation.

Declare.

Coined the Nutrition Label for products, Emser Tile has been awarded the Declare Label for its transparency in product lifecycle. From where it comes from, what it's made from, to where it goes, Emser Tile's notation of "Red List Free" can fulfill the credit disclosure requirements for LEED v4.



PRIORITIZING SUSTAINABILITY

CORPORATE EFFORTS

Emser Tile® is committed to reducing the environmental impact not only of our corporate headquarters and local sales and service locations, but also all of our distribution centers nationwide.

Our initiatives to do so include:

- Reusing technology, including cell phones, computers, and electronic equipment, through our suppliers and a third-party electronics recycling provider;
- Recycling paper through a third-party shred and recycle service;
- Automating facility lights that operate based on areas in use;
- Programming thermostats for optimal indoor temperatures while maintaining energy efficiency;
- Using low-flow and no-flush plumbing fixtures that preserve water;
- Prioritizing recycled content in office supplies;
- Emser Tile® operates strategically placed distribution centers and local sales and service locations throughout the United States. Having multiple facilities allows us to maximize the volume of every truckload for the most efficient transportation of our products, and in turn, minimizing our carbon footprint.

MATERIAL RESOURCES

Emser Tile® chooses to work with suppliers that recycle the maximum amount of material possible back into the raw bisque, which is then reused to make new tiles. Understanding the importance of water conservation, Emser Tile® suppliers also recycle and reuse water during the manufacturing process. All glazes used in the production of ceramic and porcelain tile are water based and contain zero solvents, reducing potential Volatile Organic Compound (VOC) emissions during production and further eliminating any off-gassing of our finished floor products to 0 g/L through the firing stage of manufacturing. All overseas suppliers are required to be transparent in raw ingredient reporting up to 1000ppm, allowing Emser to meet OSHA Safety Data Sheet (SDS) requirements, as well as Health Product Declarations (HPD v2.1). Preference is given to manufacturers with upgraded kiln equipment that are able to better control heat emission and indoor air quality at the factory level.

Due to their raw ingredient profiles, all products are Red List Free, Conflict Mineral Free, Lead Free and compliant to OSHA Silica Standards as well as Prop 65.

MANUFACTURING, DISTRIBUTION & INSTALLATION

Our transparency efforts specifically complement green friendly builds that are focused around environmental impact in addition to worker health and safety. Unlike other types of hard and soft flooring, the longevity of ceramic, porcelain, and natural stone prevents frequent replacement, reducing the emissions and carbon footprints related to manufacturing, transportation and disposal of waste. With a potential cradle to grave lifecycle of 100+ years, studies have shown that over a 20-year span, ceramic, porcelain, and natural stone products are more cost-effective and sustainable than any other flooring material.

For enhanced eco-friendly attributes, all products and packaging are 100% recyclable, allowing them to be easily diverted from landfills post construction. The inherent characteristics of these surfaces allow for easy installation and cleaning without the use of toxic, high VOC, or harsh chemicals, while also displaying natural antimicrobial properties reducing potential bacteria and mold growth making them a very hygienic option.

Through innovative design, these dense body products can be installed in a way that enhances indoor air quality, creating building efficiency by controlling ambient room temperatures of a space, all while reducing heating and air conditioning costs. Partnered with a Low/No VOC setting materials system, including an installation system warranty, the health, safety and longevity of the application can be optimized.

PATTERN GUIDE

Hollywood™ • Oak

SUBWAY TILE

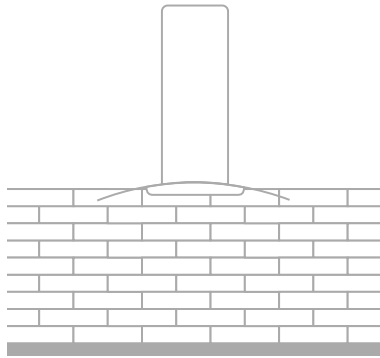

50% Offset

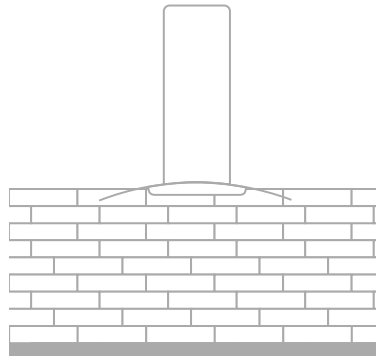

33% Offset

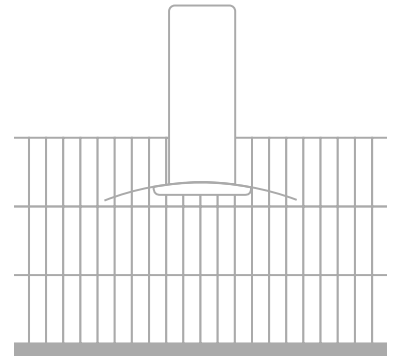

Vertical Stacked

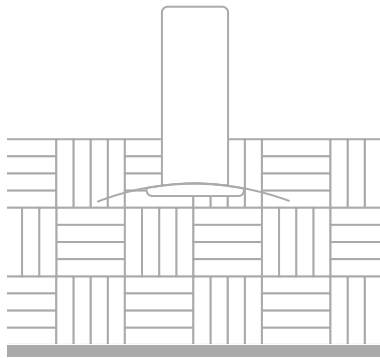

Basket Weave

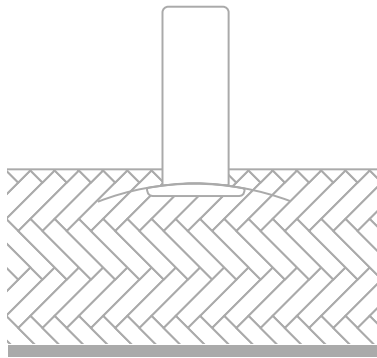

Horizontal Herringbone

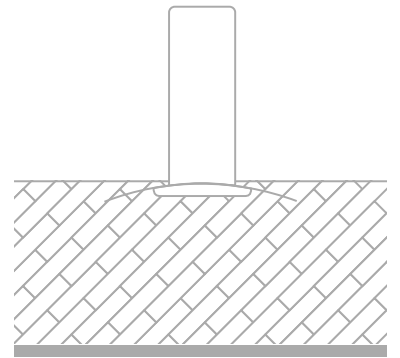

45-Degree Staggered

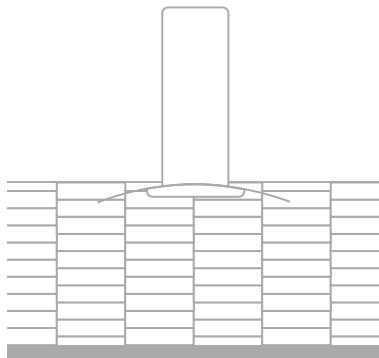

Horizontal Staggered

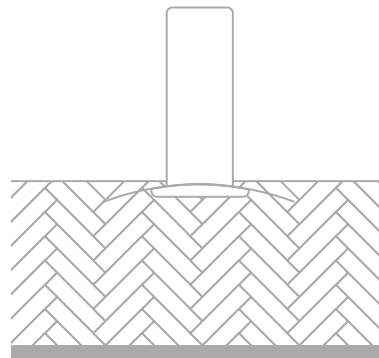

Herringbone



Zen™ • Ease
 (Photo Credit: @homkitchenandbath)

BACKSPLASH

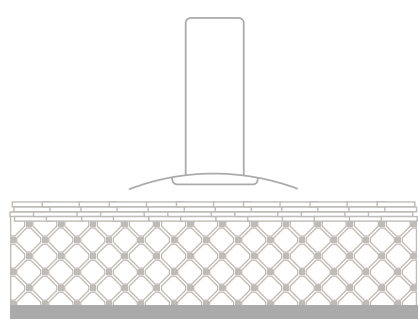

4x4 Square | Linear Mosaic

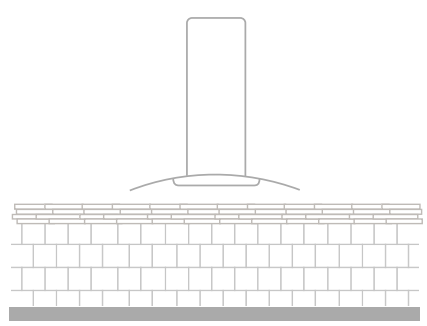

Brickwork Square | Linear Mosaic

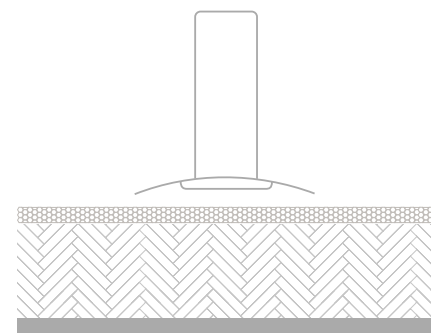

Herringbone | Penny Round Mosaic

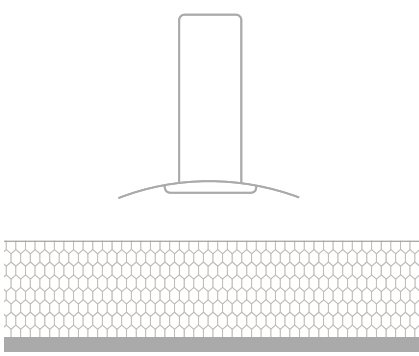

1/3 Elongated Hexagon Mosaic

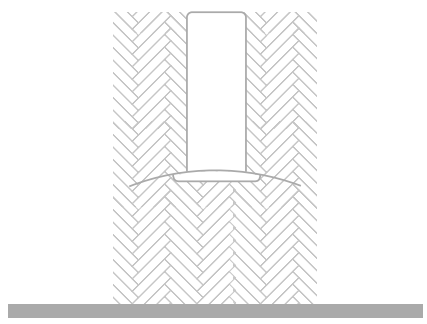

Herringbone Centered Mosaic

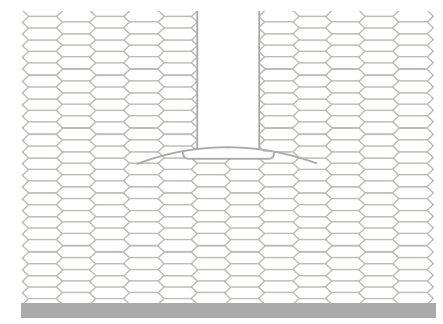

Picket Mosaic

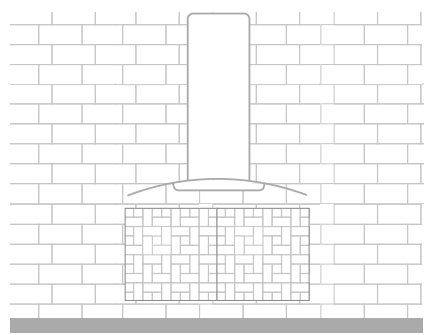

Staggered Brickwork | Windmill Mosaic

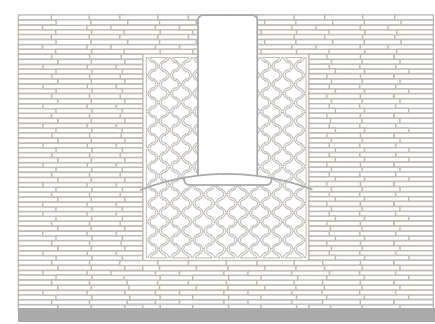

Linear Mosaic | Arabesque Mosaic

There are many choices among tile to meet all tastes and preferences. By creating a pattern with tile, one can express his or her personal style and design a truly unique space. A pattern not only alters an appearance, but it can also impact scale. The pattern suggestions are guidelines only — use your unique style and creativity to transform your space.

Our helpful Pattern Calculator can be downloaded from our website, along with our entire selection of patterns.

33% Offset is recommended for staggered floor installations.

For additional pattern selections, please visit www.emser.com.

WOOD-LOOKSIZES

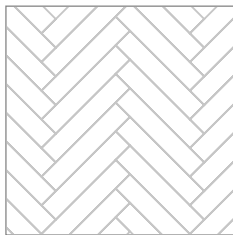

Herringbone

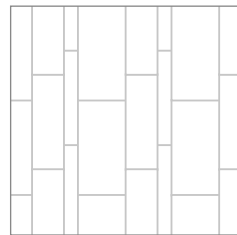

Multiple Staggered

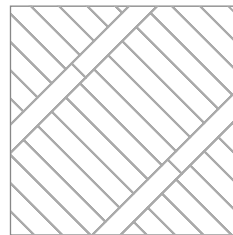

Ships Deck

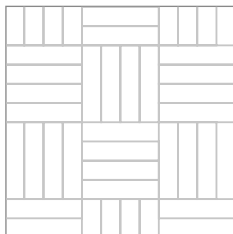

Basket Weave

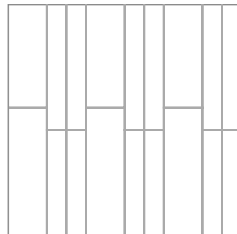

Parallel Plank

ONESIZE

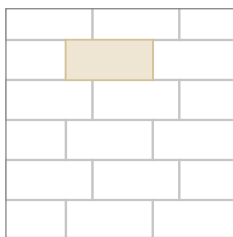

Staggered Brickwork

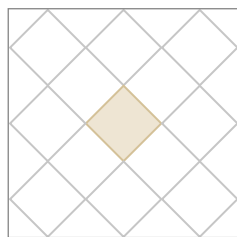

Diamond

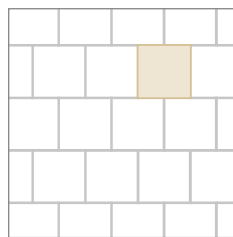

Brickwork Square

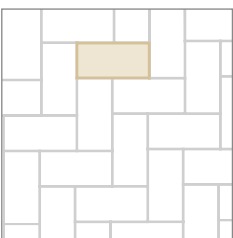

Straight Herringbone

TWOSIZES

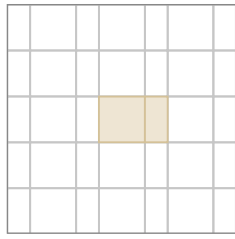

Alternating

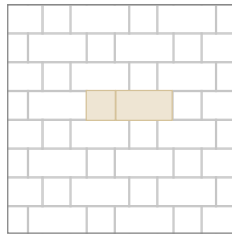

Alternating Horizontal

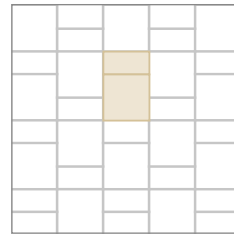

Alternating Vertical

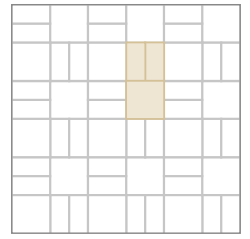

Basketweave Horizontal

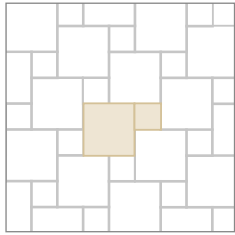

Hopscotch

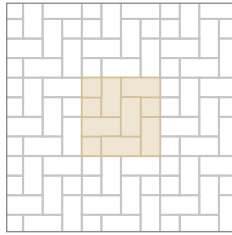

Cobblestone

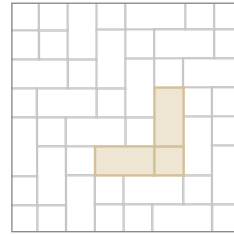

Herringbone Inserted

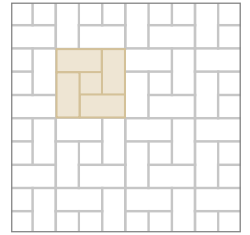

Windmill

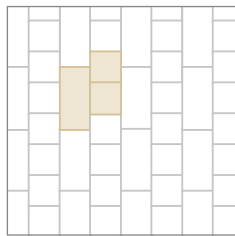

Corridor Vertical

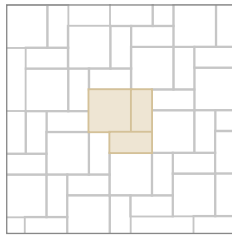

Brickweave

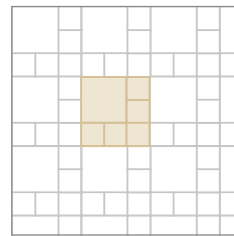

Stepping Stone

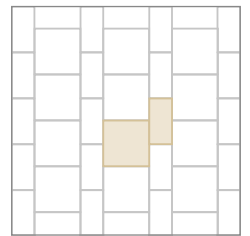

Corridor

THREESIZES

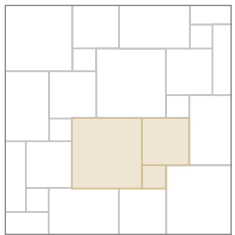

Triad Hopscotch

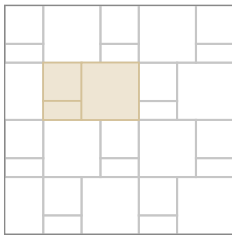

Pediment

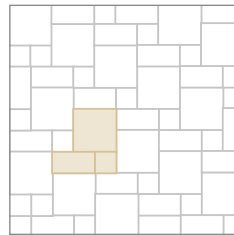

Braid

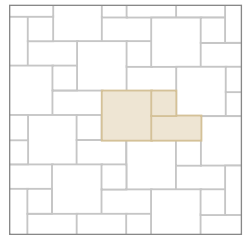

Catena

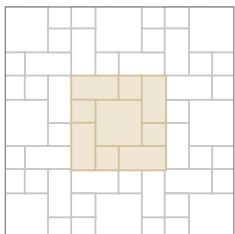

Soldiered

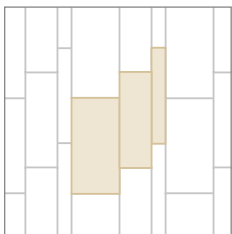

Staggered Vertical Brickwork

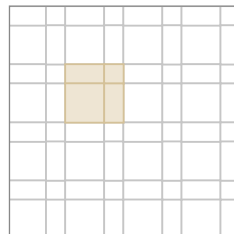

Palazzo

MULTIPLESIZES

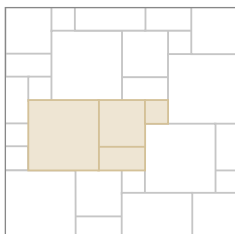

Versailles

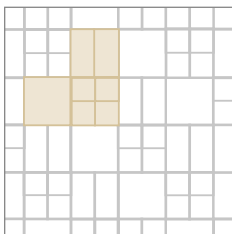

Escala

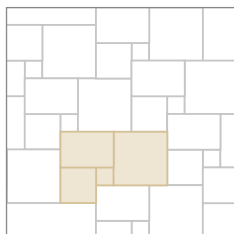

Modular Pinwheel

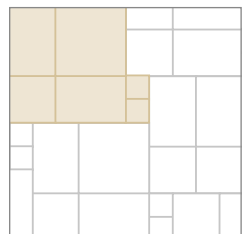



Kaleidoscope



SYMBOLS GUIDE

The symbols shown below describe the general usage and features of the products. For a more detailed technical and usage chart, please refer to the resources section or visit us online at emser.com.

QUALITY STANDARDS

	DCOF	BREAKING STRENGTH	SCRATCH HARDNESS	
	>0.42%	>250 lbf	5	FLOOR / WALL 
	ANY	>250 lbf	5	RESIDENTIAL 
	N/A	>125 lbf	3	WALL 
	>0.42% (Wet) ANY (Dry)	>350 lbf	7	COMMERCIAL 
WALL:	N/A	>125 lbf	3	OUTDOOR 
FLOOR:	>0.55 (Uncovered)	>250 lbf	5(R) / 7(C)	
	ANY	>250 lbf	5	INDOOR 
DECK:	>0.60%	>250 lbf	5(R) / 7(C)	POOL 
WATERLINE:	ANY	>125 lbf	3	



GOLINEAR

Cut-To-Size Custom Ordering

Emser Tile® offers various cut-to-size options for all rectified products.

Please inquire about lead times and pricing. Sizes can be specified within the limits of the dimension of the standard field tiles.

Suggested sizes include but are not limited to:

2x12, 2x24, 4x12, 4x24, 6x12, and 6x24

	12"	24"
20"		
18"		
16"		
12"		
8"		
6"		
4"		
2"		



Sweden™ Alps

Go Linear™ Collections

Access II

Action

Archive

Beach Wood

Borigni

BB Concrete

BB Wood | Oak

BB Wood | Yakedo

Cassero II

Chiado II

Citizen

Council

Expanse

Hangar

Hollywood

Legacy

Milestone

Mood

Network

Newport

Orchard

Outpost

Porch

Porto II

Sterlina

Style II

Sweden

Swiss II

Terazio

Theory

Thread II

Uptown

Xtra

...mosaics and more!

Sterlina™ Dove
12"x24" cut to 6"x24"



INDEX

BY COLLECTION

Floor Tile

Access II	15	Denova	81	Porto II	151
Action	17	Design	83	Potenza	153
Albero	19	Dunham	85	Realm II	155
Angeles	21	Erosion	87	Reminisce	157
Anthem	23	Esplanade	89	Reserva	159
Archive	25	Eurasia	91	Rhapsody	161
Baja	27	Expanse	93	Rhythm	163
Banzai	29	Explorer	97	Sanctuary II	165
Bauhaus	31	Facade	99	Sandstorm	167
Beach Wood	33	Geometry	101	Señora	169
Beckway	35	Giza	103	Serendra	171
Belstar	37	Hangar	105	Silhouette	173
Borgata	39	Havana	107	Sterlina	175
Borigni	41	Heksa	109	Style II	177
Brava	43	Hollywood	111	Sweden	179
Brique	45	Ironworx	113	Swiss II	181
Brook	47	Larchmont	115	Technique	183
Building Blocks™ Concrete	49	Latitude	117	Terazio	185
Building Blocks™ Metal	51	Legacy	119	Tesola	187
Building Blocks™ Wood Oak	53	Livorno	121	Theory	189
Building Blocks™ Wood Yakedo	55	Milestone	123	Thread II	191
Cabin	57	Mokuzai II	125	Toledo	193
Cabo	59	Mood	127	Trendz	195
Cassero II	61	Motion	129	Trovata II	197
Chiado II	63	Network	131	Uddo	199
Chronicle	65	Newport	133	Uptown	201
Citizen	67	Nostalgia	135	Vara	203
Ciudad	69	Nova	137	Velocity	205
Contessa	71	Orchard	139	Victus	207
Cortijo	73	Outpost	141	Virtue	209
Cosmopolitan	75	Parkview	143	Xtra	211
Council	77	Pienza	145		
Daroca	79	Pocono	147		
		Porch	149		



Wall Tile

Artwork	215
Back to Basics	217
Bimova	221
Catch	223
Center	225
Choice II	227
Code	229
Colori	231
Connect	233
Craft II	235
Emora	237
Euphoria	239
Express	241
Fregio	243
Glow	245
Hues	247
Immerse	249
Jazz	251
Kudos	253
Luxo	255
Marquesa	257
Motif II	259
Nuovo	261
Ombre	263
Passion	265
Place2B	267
Raku	269
Rift	271
Sculpture	273
Sonata	275
Sparkle	277
Sphere	279
Synergy	281
Vertigo	283

Decorative Tile

Afloat	287	Modan	353
Alluro	289	Morocco	355
Bizou	291	Mythos	357
Catalyst	293	Nagara	359
Charisma	295	Omni	361
Concept	297	Picket	363
Confetti II	299	Retro II	365
Cultura	301	Reward	367
Diva	303	Rezone	369
Echo	305	Rivera Pebbles	371
Edge	307	Source	373
Entity	309	Spin	375
Feature	311	Splash	377
Fleur	313	Unique	379
Glitz	315	Venetian Pebbles	381
H2O	317	Volare	383
Hanami	319	Waterlace	385
Illumina	321	Zen	387
Impact	323		
Impulse	325	<i>Natural Stone</i>	
Infinity	327	Marble	391
Influence	329	Metro	401
Intrigue	331	Trav Ancient Tumbled	405
Irish	333	Trav Chiseled	406
Kaze	335	Trav Fontane Tumbled	407
Kinetic	337	Travertine Crosscut	408
Kumito	339	Travertine Veincut	409
La Vie	341	Limestone	411
L'Amour	343	Slate, Quartzite & Sandstone	413
Link	345	Structure	417
Literati	347	Granite	419
Lucente	349	E-Quarry	421
Mizu	351		





Erosion™ • Valley 12" x 24"



FLOOR TILE

FLOOR / WALL  RESIDENTIAL  COMMERCIAL  INDOOR  OUTDOOR 



Path



Route



Tour



Voyage

Mosaics



Path







Route



Tour



Voyage

Sizes							
	24"x47" 23.62"x47.24"	12"x24" 11.81"x23.62"	12"x12" Mesh 11.73"x11.73"	3"x12" Floor SBN			
Thickness	10mm	10mm	10mm	10mm			
Faces	4	16	N/A	N/A			
Finish	Matte	Matte	Matte	Matte			
Edge	Rectified	Rectified	Cut	Cut			
Grout Joint Recommendation	3/16"	3/16"	3/16"	3/16"			
Testing	Abrasion Resistance C1027	Breaking Strength C648	Chemical Resistance C650	Water Absorption C373	DCOF ANSI A1371	Scratch Hardness MOHS	Shade Variation Rating
	IV	≥425 lbf	Resistant	<0.5%	>0.50	6	V3

Product and Installation Details | ANSI A108.02
Section 4.3.8.2 - For running bond/brick jointing patterns utilizing tiles (square or rectangular) where the side being offset is greater than 18" (nominal dimension), the running bond offset will be a maximum of 33% unless otherwise specified by the tile manufacturer. If an offset greater than 33% is specified, specifier and owner must approve mock-up and lippage.



 Sustainability Attributes

- Red List Free
- Health Product Declaration (HPD) provided upon request
- Product Packaging is 100% recyclable
- VOC Free

*For more information visit www.emser.com. Always consult a professional for proper usage and installation.

Access II™ brings the classic aesthetic of sandstone to life through dynamic patterning. High-definition swathes of color shift across the tile for visual movement. Cool tones in a matte finish lend an approachable sense of modernity.

ACCESS II™

Glazed Porcelain





FLOOR / WALL  RESIDENTIAL  COMMERCIAL  INDOOR 



Advance



Cue

Sizes							
	11" x 23" 11.41" x 23.23"	3" x 23" Floor SBN					
Thickness	10mm	10mm					
Faces	24	N/A					
Finish	Polished	Polished					
Edge	Rectified	Cut/Rounded					
Grout Joint Recommendation	1/8"	5/64"					
Testing	Abrasion Resistance C1027	Breaking Strength C648	Chemical Resistance C650	Water Absorption C373	DCOF ANSI A1371	Scratch Hardness MOHS	Shade Variation Rating
	Results* V	>500 lbf	Resistant	≤.50%	<0.42	7	V2

Product and Installation Details | ANSI A108.02
 Section 4.3.8.2 - For running bond/brick jointing patterns utilizing tiles (square or rectangular) where the side being offset is greater than 18" (nominal dimension), the running bond offset will be a maximum of 33% unless otherwise specified by the tile manufacturer. If an offset greater than 33% is specified, specifier and owner must approve mock-up and lippage.



 Sustainability Attributes

- Red List Free
- Health Product Declaration (HPD) provided upon request
- Product Packaging is 100% recyclable
- VOC Free

*For more information visit www.emser.com. Always consult a professional for proper usage and installation.



Action™ uses high-definition printing to recreate veincut marble in a modern color palette with a beautiful polished finish. All colors are available in a matte finish in our Motion™ series.

ACTION™

Glazed Body Match Porcelain



FLOOR / WALL



RESIDENTIAL



INDOOR



Bosco



Foresta



Pianta



Ramo

Sizes



8" x 24"
795" x 2370"

Thickness

8.6mm

Faces

8

Finish

Matte

Edge

Pressed

Grout Joint Recommendation

3/16"

Testing

Abrasion Resistance
C1027

Breaking Strength
C648

Chemical Resistance
C650

Water Absorption
C373

DCOF ANSI
A1371

Scratch Hardness
MOHS

Shade Variation
Rating

Results*

III

<250 lbf

Not Resistant

>7.0%

>0.45

7

V2

Product and Installation Details | ANSI A108.02
Section 4.3.8.2 - For running bond/brick jointing patterns utilizing tiles (square or rectangular) where the side being offset is greater than 18" (nominal dimension), the running bond offset will be a maximum of 33% unless otherwise specified by the tile manufacturer. If an offset greater than 33% is specified, specifier and owner must approve mock-up and lippage.



Sustainability Attributes

- Red List Free
- Health Product Declaration (HPD) provided upon request
- Product Packaging is 100% recyclable
- VOC Free

*For more information visit www.emser.com. Always consult a professional for proper usage and installation.

Albero™ skillfully incorporates the visual features of wood in glazed ceramic tile. Bringing to life the warmth and cozy feeling of natural wood, it is offered in natural earthy colors and a standard wood plank size.

ALBERO™

Glazed Ceramic



FLOOR / WALL  RESIDENTIAL  COMMERCIAL  INDOOR  OUTDOOR 



Apex



Cliff



Crest

Sizes Thickness Faces Finish Edge Grout Joint Recommendation							
	9" x 47" 9.17" x 47.24"						
	10.5mm						
	18						
	Matte						
	Pressed						
3/16"							
Testing	Abrasion Resistance C1027	Breaking Strength C648	Chemical Resistance C650	Water Absorption C373	DCOF ANSI A1371	Scratch Hardness MOHS	Shade Variation Rating
Results*	III	≥300 lbf	Resistant	≤0.50%	≥0.60	7	V3

Product and Installation Details | ANSI A108.02
 Section 4.3.8.2 - For running bond/brick jointing patterns utilizing tiles (square or rectangular) where the side being offset is greater than 18" (nominal dimension), the running bond offset will be a maximum of 33% unless otherwise specified by the tile manufacturer. If an offset greater than 33% is specified, specifier and owner must approve mock-up and lippage.



 Sustainability Attributes

- Red List Free
- Health Product Declaration (HPD) provided upon request
- Product Packaging is 100% recyclable
- VOC Free

*For more information visit www.emser.com. Always consult a professional for proper usage and installation.

Angeles™ celebrates the beauty of nature using high-definition graphic technology to mimic the unique gradations and variances found in natural wood.

ANGELES™

Glazed Porcelain



FLOOR / WALL  RESIDENTIAL  COMMERCIAL  INDOOR  OUTDOOR 



White



Gray





Mosaics



White



Gray

Sizes							
	18"x18" 17.60"x17.60"	13"x23" 12.68"x22.56"	12"x12" 12.28"x12.28"	12"x12" Mesh 12.28"x12.28"	3"x12" Floor SBN		
Thickness	8.4mm	8.4mm	8mm	7.3mm	8.4mm		
Faces	8	8	8	N/A	N/A		
Finish	Matte	Matte	Matte	Matte	Matte		
Edge	Pressed	Pressed	Pressed	Pressed	Pressed		
Grout Joint Recommendation	3/16"	3/16"	3/16"	5/32"	5/32"		
Testing	Abrasion Resistance C1027	Breaking Strength C648	Chemical Resistance C650	Water Absorption C373	DCOF ANSI A1371	Scratch Hardness MOHS	Shade Variation Rating
	IV	≥250 lbf	Non-Resistant	>5.0%	<0.42	7	V2

Product and Installation Details | ANSI A108.02
Section 4.3.8.2 - For running bond/brick jointing patterns utilizing tiles (square or rectangular) where the side being offset is greater than 18" (nominal dimension), the running bond offset will be a maximum of 33% unless otherwise specified by the tile manufacturer. If an offset greater than 33% is specified, specifier and owner must approve mock-up and lippage.



 Sustainability Attributes

- Red List Free
- Health Product Declaration (HPD) provided upon request
- Product Packaging is 100% recyclable
- VOC Free

*For more information visit www.emser.com. Always consult a professional for proper usage and installation.

Anthem™ embodies the minimalist effects of limestone with abstract movement in a durable ceramic tile. Exploring the boundaries of what limestone-like shading can evoke, Anthem's earthy tones result in a cool, contemporary surface.

ANTHEM™

Glazed Ceramic



FLOOR / WALL  RESIDENTIAL  INDOOR 



Era



Memoir



Mosaics



Era



Memoir

Sizes							
	11" x 23" 11.42" x 23.23"	12" x 12" Mesh 12.01" x 12.01"	3" x 23" Floor SBN				
Thickness	9.8mm	9.8mm	9.8mm				
Faces	16	N/A	N/A				
Finish	Polished	Polished	Polished				
Edge	Rectified	Rectified	Rectified				
Grout Joint Recommendation	3/16"	3/16"	3/16"				
Testing	Abrasion Resistance C1027	Breaking Strength C648	Chemical Resistance C650	Water Absorption C373	DCOF ANSI A1371	Scratch Hardness MOHS	Shade Variation Rating
	III	≥350 lbf	Resistant	≤0.50%	<0.42	9	V2

Product and Installation Details | ANSI A108.02
 Section 4.3.8.2 - For running bond/brick jointing patterns utilizing tiles (square or rectangular) where the side being offset is greater than 18" (nominal dimension), the running bond offset will be a maximum of 33% unless otherwise specified by the tile manufacturer. If an offset greater than 33% is specified, specifier and owner must approve mock-up and lippage.



 Sustainability Attributes

- Red List Free
- Health Product Declaration (HPD) provided upon request
- Product Packaging is 100% recyclable
- VOC Free

*For more information visit www.emser.com. Always consult a professional for proper usage and installation.

Archive™ is inspired by the structural movement of veincut marble. Bold lines and color variation bring heightened contrast to draw in the eye. Available in a matte finish in our Chronicle™ series.

ARCHIVE™

Glazed Porcelain





Ensenada



Mexicali



Rosarito



Tecate

Mexicali, Rosarito, and Tecate Available in Sizes 18"x18", 12"x24"
 Ensenada Available in 18"x18", 14"x14", 12"x24"

Mosaics

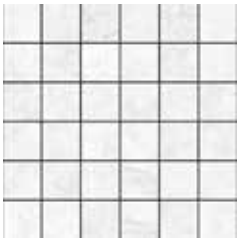

Ensenada







Mexicali



Rosarito



Tecate

Sizes							
	18"x18" 17.72"x17.72"	14"x14" 13.78"x13.78"	12"x24" 12.01"x23.86"	13"x13" Mesh 12.99"x12.99"	3"x13" SBN Ensenada Only		
Thickness	8.3-9.0mm	8.0-8.5mm	9.1-9.5mm	8.5mm	8.5mm		
Faces	5	4	8	N/A	N/A		
Finish	Matte	Matte	Matte	Matte	Matte		
Edge	Pressed	Pressed	Pressed	Cut	Cut		
Grout Joint Recommendation	3/16"	3/16"	3/16"	3/16"	3/16"		
Testing	Abrasion Resistance C1027	Breaking Strength C648	Chemical Resistance C650	Water Absorption C373	DCOF ANSI A1371	Scratch Hardness MOHS	Shade Variation Rating
Results*	IV	≥250 lbf	Resistant	≤7%	≥0.42	7	V2

Product and Installation Details | ANSI A108.02
 Section 4.3.8.2 - For running bond/brick jointing patterns utilizing tiles (square or rectangular) where the side being offset is greater than 18" (nominal dimension), the running bond offset will be a maximum of 33% unless otherwise specified by the tile manufacturer. If an offset greater than 33% is specified, specifier and owner must approve mock-up and lippage.



Sustainability Attributes

- Red List Free
- Health Product Declaration (HPD) provided upon request
- Product Packaging is 100% recyclable
- VOC Free

*For more information visit www.emser.com. Always consult a professional for proper usage and installation.

Baja™ brings the simple elegance of natural limestone in a ceramic tile. A universally appealing color palette and varied sizes offers numerous design opportunities.

BAJA™
Glazed Ceramic



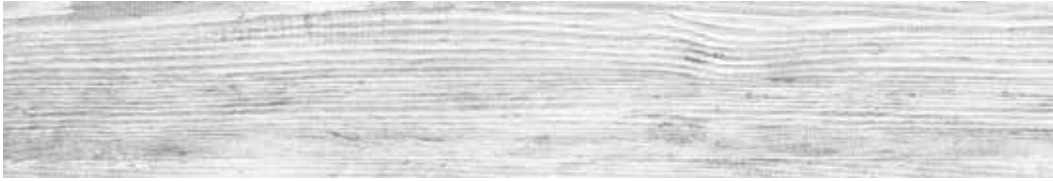

Ardor



Fervor



Honor



Rigor



Valor

Sizes Thickness Faces Finish Edge Grout Joint Recommendation							
	6" x 35" 5.91" x 35.43"						
	10mm						
	10						
	Matte						
Pressed							
3/16"							
Testing	Abrasion Resistance C1027	Breaking Strength C648	Chemical Resistance C650	Water Absorption C373	DCOF ANSI A1371	Scratch Hardness MOHS	Shade Variation Rating
Results*	III IV (Ardor)	>250 lbf	Resistant	<0.5%	>0.60	7	V2

Product and Installation Details | ANSI A108.02
 Section 4.3.8.2 - For running bond/brick jointing patterns utilizing tiles (square or rectangular) where the side being offset is greater than 18" (nominal dimension), the running bond offset will be a maximum of 33% unless otherwise specified by the tile manufacturer. If an offset greater than 33% is specified, specifier and owner must approve mock-up and lippage.



Sustainability Attributes

- Red List Free
- Health Product Declaration (HPD) provided upon request
- Product Packaging is 100% recyclable
- VOC Free

*For more information visit www.emser.com. Always consult a professional for proper usage and installation.



Banzai™ porcelain tile features the highly coveted wood look perfect for those who love design – from modern to classic cottage, and all styles in-between. Banzai is available in 6" x 35" planks with five wood-looks.

BANZAI™
Glazed Porcelain



FLOOR / WALL  RESIDENTIAL  COMMERCIAL  INDOOR  OUTDOOR 



White



Croix

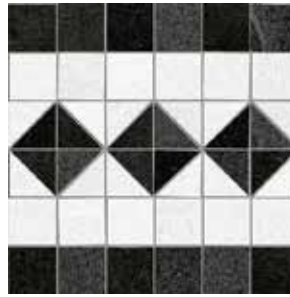

Krix



Krix Corner

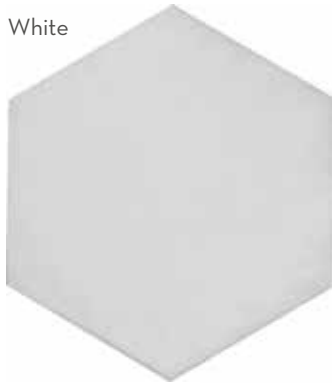

White



Silver



Gray



Arrow

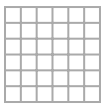
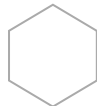

Floral

Sizes							
	8" x 8" 7.87" x 7.87"	9" x 10" 9.06" x 10.47"					
Thickness	8mm	9mm					
Faces	10	10 15 (Floral)					
Finish	Matte	Matte					
Edge	Rectified	Pressed					
Grout Joint Recommendation	1/8"	1/8"					
Testing	Abrasion Resistance C1027	Breaking Strength C648	Chemical Resistance C650	Water Absorption C373	DCOF ANSI A1371	Scratch Hardness MOHS	Shade Variation Rating
	III	>350 lbf (8x8) >375 lbf (Hex)	Resistant	<0.50%	>0.55 (8x8) >0.60 (Hex)	6	V2



 Sustainability Attributes

- Red List Free
- Health Product Declaration (HPD) provided upon request
- Product Packaging is 100% recyclable
- VOC Free

*For more information visit www.emser.com. Always consult a professional for proper usage and installation.

Bauhaus honors a design movement that continues to inspire today. The collection stresses the inherent beauty in geometry and simplicity, as well as the importance of quality materials. Subtle color gradations draw the eye and create a unique visual experience, whether on walls or on floors.

BAUHAUS

Glazed Porcelain



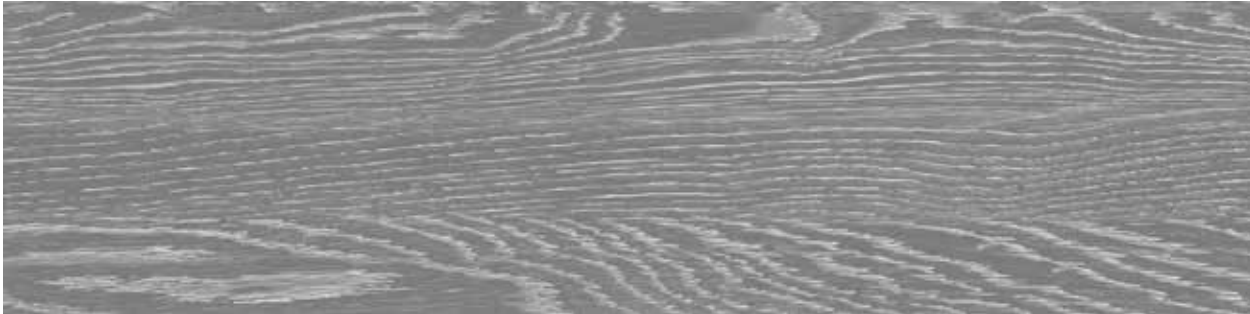

Erie

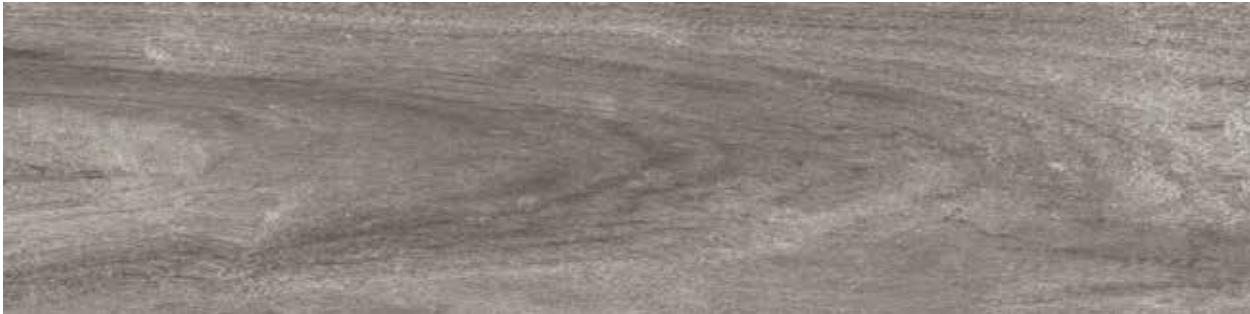

Nasser



Tahoe

Sizes Thickness Faces Finish Edge Grout Joint Recommendation							
	8" x 34" 8.15" x 34.17"						
	10mm						
	20						
	Matte						
	Rectified						
1/8"							
Testing	Abrasion Resistance C1027	Breaking Strength C648	Chemical Resistance C650	Water Absorption C373	DCOF ANSI A1371	Scratch Hardness MOHS	Shade Variation Rating
Results*	IV	≥550 lbf	Resistant	≤0.50%	≥0.55	7	V4

Product and Installation Details | ANSI A108.02
 Section 4.3.8.2 - For running bond/brick joining patterns utilizing tiles (square or rectangular) where the side being offset is greater than 18" (nominal dimension), the running bond offset will be a maximum of 33% unless otherwise specified by the tile manufacturer. If an offset greater than 33% is specified, specifier and owner must approve mock-up and lippage.



Sustainability Attributes

- Red List Free
- Health Product Declaration (HPD) provided upon request
- Product Packaging is 100% recyclable
- VOC Free
- Recycled Content 5% Pre-Consumer and 3% Post-Consumer

*For more information visit www.emser.com. Always consult a professional for proper usage and installation.

Beach Wood™ breathes life into contemporary surfaces in the form of wood look panels. Beach Wood™ consists of distinct wooden tones which evoke rich detail and texture across a variety of faces.

BEACH WOOD

Glazed Porcelain



FLOOR / WALL  RESIDENTIAL  COMMERCIAL  INDOOR  OUTDOOR 



Beige



Taupe



Honey

Sizes Thickness Faces Finish Edge Grout Joint Recommendation							
	6" x 24" 5.91" x 23.62"						
	8mm						
	9						
	Matte						
	Pressed						
Testing	Abrasion Resistance <small>C1027</small>	Breaking Strength <small>C648</small>	Chemical Resistance <small>C650</small>	Water Absorption <small>C373</small>	DCOF ANSI <small>A1371</small>	Scratch Hardness MOHS	Shade Variation Rating
Results*	III	>350 lbf	Resistant	<0.50%	>0.55	7	V3

Product and Installation Details | ANSI A108.02
 Section 4.3.8.2 - For running bond/brick joining patterns utilizing tiles (square or rectangular) where the side being offset is greater than 18" (nominal dimension), the running bond offset will be a maximum of 33% unless otherwise specified by the tile manufacturer. If an offset greater than 33% is specified, specifier and owner must approve mock-up and lippage.



 Sustainability Attributes

- Red List Free
- Health Product Declaration (HPD) provided upon request
- Product Packaging is 100% recyclable
- VOC Free

*For more information visit www.emser.com. Always consult a professional for proper usage and installation.



The Beckway™ series provides the classic look of wood with the ease of care that only porcelain tile can provide. With a neutral color palette reminiscent of the finest woods, Beckway is perfect for traditional and modern settings. Available in a 6"x24" size, this natural looking wood tile is sure to bring life to any room.

BECKWAY™

Glazed Porcelain



FLOOR / WALL  RESIDENTIAL  INDOOR 





White

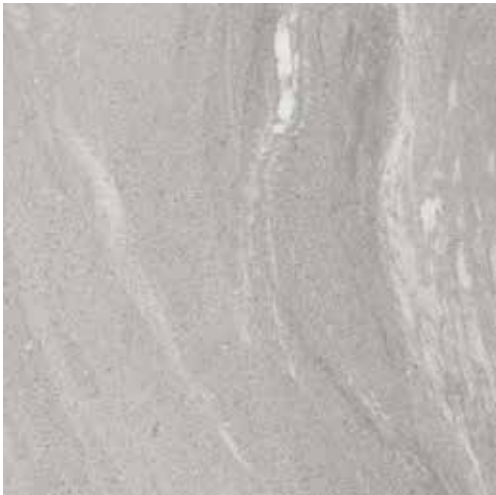

Sand



Gray

Sizes							
	16" x 16" 15.87" x 15.87"	12" x 12" Mesh	3" x 16" Floor SBN				
Thickness	8,5mm	8,5mm	8,5mm				
Faces	9	N/A	N/A				
Finish	Matte	Matte	Matte				
Edge	Pressed	Cut	Cut/Rounded				
Grout Joint Recommendation	3/16"	3/16"	3/16"				
Testing	Abrasion Resistance C1027	Breaking Strength C648	Chemical Resistance C650	Water Absorption C373	DCOF ANSI A1371	Scratch Hardness MOHS	Shade Variation Rating
	Check Website	Check Website	Check Website	Check Website	Check Website	Check Website	V3

 Sustainability Attributes

- Red List Free
- Health Product Declaration (HPD) provided upon request
- Product Packaging is 100% recyclable
- VOC Free

*For more information visit www.emser.com. Always consult a professional for proper usage and installation.



Simplicity meets style. Subtly reminiscent of the layered look associated with sandstone, Belstar™ ceramic tile breathes elegance into installations. Well-loved neutrals in both warm and cool tones strike the right balance with variation in both color and texture.

BELSTAR™
Glazed Ceramic

FLOOR / WALL  RESIDENTIAL  INDOOR 







White



Ivory



Silver

Sizes							
	16" x 16" 15.87" x 15.87"	12" x 24"	12" x 12" Mesh	3" x 12" Floor SBN			
	Thickness	8.5mm	8.5mm	Check Website	Check Website		
	Faces	12	8	N/A	N/A		
	Finish	Matte	Matte	Matte	Matte		
	Edge	Pressed	Pressed	Cut	Cut/Rounded		
Grout Joint Recommendation	3/16"	3/16"	3/16"	3/16"			
Testing	Abrasion Resistance C1027	Breaking Strength C648	Chemical Resistance C650	Water Absorption C373	DCOF ANSI A1371	Scratch Hardness MOHS	Shade Variation Rating
Results*	Check Website	Check Website	Check Website	Check Website	Check Website	Check Website	V2

 Sustainability Attributes

- Red List Free
- Health Product Declaration (HPD) provided upon request
- Product Packaging is 100% recyclable
- VOC Free

*For more information visit www.emser.com. Always consult a professional for proper usage and installation.

Modern luxury comes alive with the stone look of Borgata™ ceramic tile. Designed for use on both floors and walls, the elegance of shading and veining is front and center with this collection of neutrals. Available in two sizes and three neutral colors, Borgata makes a statement reality.

BORGATA™

Glazed Ceramic

FLOOR / WALL  RESIDENTIAL  COMMERCIAL  INDOOR  OUTDOOR 



White



Beige







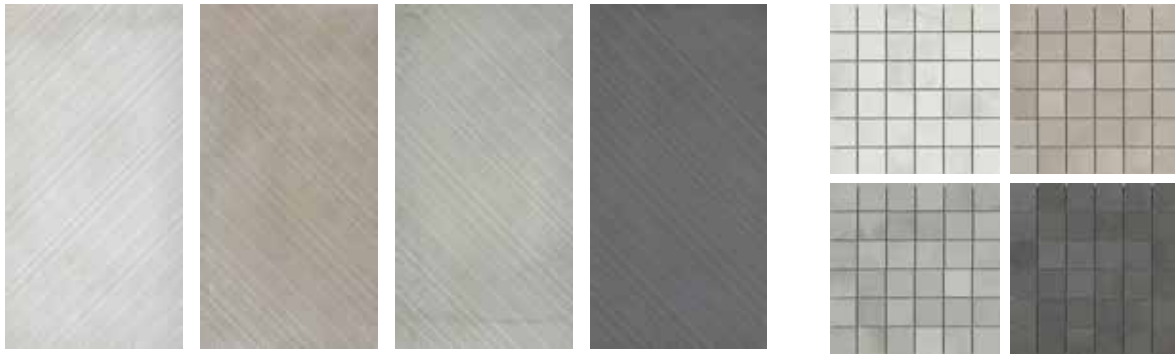

Gray



Black



Diagonal Pattern Available in 18"x35" Only | Left & Right Styles Available

Sizes							
	35" x 35" 35.24" x 35.24"	18" x 35" 17.54" x 35.15"	12" x 23" 11.67" x 23.43"	12" x 12" Mesh 11.81" x 11.81"	3" x 12" Floor SBN	6" x 12" Cove Base	1" x 6" Cove Base Corner Out
Thickness	10mm	10mm	10mm	10mm	10mm	8.9mm	8.5mm
Faces	10	20	20	N/A	N/A	N/A	N/A
Finish	Matte	Matte	Matte	Matte	Matte	Matte	Matte
Edge	Rectified	Rectified	Rectified	Cut	Cut/Rounded	Pressed	Rectified
Grout Joint Recommendation	1/8"	1/8"	1/8"	1/8"	1/8"	1/8"	1/8"
Testing	Abrasion Resistance C1027	Breaking Strength C648	Chemical Resistance C650	Water Absorption C373	DCOF ANSI A1371	Scratch Hardness MOHS	Shade Variation Rating
	IV	≥250 lbf	Resistant	≤0.50%	>0.55	5	V2

Product and Installation Details | ANSI A108.02
Section 4.3.8.2 - For running bond/brick jointing patterns utilizing tiles (square or rectangular) where the side being offset is greater than 18" (nominal dimension), the running bond offset will be a maximum of 33% unless otherwise specified by the tile manufacturer. If an offset greater than 33% is specified, specifier and owner must approve mock-up and lippage.



Sustainability Attributes

- Red List Free
- Health Product Declaration (HPD) provided upon request
- Product Packaging is 100% recyclable
- VOC Free

*For more information visit www.emser.com. Always consult a professional for proper usage and installation.



Borigni™ is a glazed body match porcelain with an industrial, urban aesthetic. Replicating the look of concrete in a variety of sizes, patterns and mosaics, Borigni™ provides a seamless look indoors to outdoors.

BORIGNI™

Glazed Body Match Porcelain



FLOOR / WALL  RESIDENTIAL  COMMERCIAL  INDOOR  OUTDOOR 



Ivory



Taupe



Brown



Silver



Carbon

Mosaics

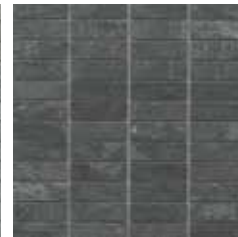
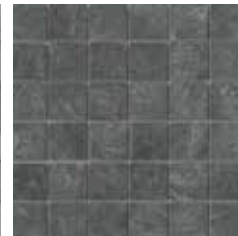





Ivory

Taupe

Brown

Silver

Carbon

Sizes							
	13" x 13" 13.11" x 13.11"	12" x 24" 11.81" x 23.62"	13" x 13" Mesh	13" x 13" Mesh	3" x 13" Floor SBN		
Thickness	8.5mm	10mm	8.5mm	8.5mm	8.5mm		
Faces	17	11	N/A	N/A	N/A		
Finish	Matte	Matte	Matte	Matte	Matte		
Edge	Pressed	Pressed	Cut	Cut	Cut/Rounded		
Grout Joint Recommendation	3/16"	3/16"	3/16"	3/16"	3/16"		
Testing	Abrasion Resistance C1027	Breaking Strength C648	Chemical Resistance C650	Water Absorption C373	DCOF ANSI A1371	Scratch Hardness MOHS	Shade Variation Rating
	IV	>325 lbf	Resistant	<0.50%	>0.45	8	V2

Product and Installation Details | ANSI A108.02
Section 4.3.8.2 - For running bond/brick jointing patterns utilizing tiles (square or rectangular) where the side being offset is greater than 18" (nominal dimension), the running bond offset will be a maximum of 33% unless otherwise specified by the tile manufacturer. If an offset greater than 33% is specified, specifier and owner must approve mock-up and lippage.



 Sustainability Attributes

- Red List Free
- Health Product Declaration (HPD) provided upon request
- Product Packaging is 100% recyclable
- VOC Free

*For more information visit www.emser.com. Always consult a professional for proper usage and installation.

Brava™ artfully brings to life the texture and feel of slate in durable glazed porcelain. Offered in multiple sizes and colors to complete any project.

BRAVA™
Glazed Porcelain





Cotto



White



Silver



Gray



Charcoal

Sizes Thickness Faces Finish Edge Grout Joint Recommendation	<input type="text"/>						
	2" x 10" 2,36" x 9,84"						
	8mm						
	24						
	Matte						
	Pressed						
	3/16"						
Testing	Abrasion Resistance <small>C1027</small>	Breaking Strength <small>C648</small>	Chemical Resistance <small>C650</small>	Water Absorption <small>C373</small>	DCOF ANSI <small>A1371</small>	Scratch Hardness <small>MOHS</small>	Shade Variation Rating
Results*	Check Website	>400 lbf	Resistant	<0.50%	>0.65	6	V4

Sustainability Attributes

- Red List Free
- Health Product Declaration (HPD) provided upon request
- Product Packaging is 100% recyclable
- VOC Free

*For more information visit www.emser.com. Always consult a professional for proper usage and installation.

What do you get when you take one of the world's oldest and humblest building materials and elevate it? Brique™! Consider for a statement wall in your kitchen or a durable statement floor sure to get compliments. Colors come in both cool and warm tones encouraging options for all tastes.

BRIQUE™

Glazed Porcelain





White





Silver



Cream



Graphite

Sizes							
	18" x 18" 17.72" x 17.72"	14" x 14" 13.78" x 13.78"	12" x 24" 12.01" x 23.86"				
	Thickness	8.3-9.0mm	8.1-8.5mm	8.8-9.2mm			
	Faces	12	24	16			
	Finish	Matte	Matte	Matte			
	Edge	Pressed	Pressed	Pressed			
Grout Joint Recommendation	3/16"	3/16"	3/16"				
Testing	Abrasion Resistance C1027	Breaking Strength C648	Chemical Resistance C650	Water Absorption C373	DCOF ANSI A1371	Scratch Hardness MOHS	Shade Variation Rating
Results*	Graphite: II Silver, Cream: III White: IV	>250 lbf	Resistant	3.0-7.0%	>0.42	6	V4

Product and Installation Details | ANSI A108.02
 Section 4.3.8.2 - For running bond/brick jointing patterns utilizing tiles (square or rectangular) where the side being offset is greater than 18" (nominal dimension), the running bond offset will be a maximum of 33% unless otherwise specified by the tile manufacturer. If an offset greater than 33% is specified, specifier and owner must approve mock-up and lippage.



 Sustainability Attributes

- Red List Free
- Health Product Declaration (HPD) provided upon request
- Product Packaging is 100% recyclable
- VOC Free

*For more information visit www.emser.com. Always consult a professional for proper usage and installation.

Brook™ features the subtle and calming movement of a flowing river. The four earthy shades and three standard sizes provides endless design opportunities. The timeless and versatile design is sure to enhance any space.

BROOK™
Glazed Ceramic





Black



Gray

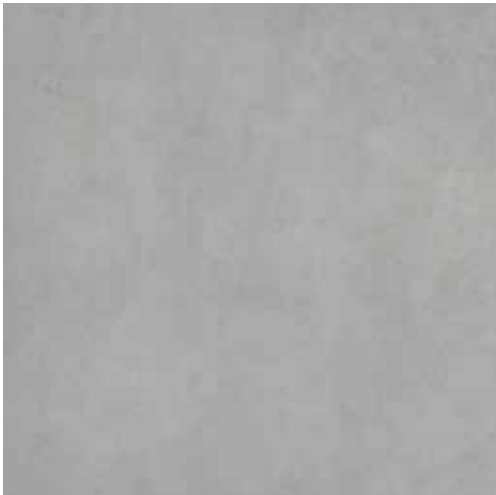

Silver



Mist

Sizes							
	29" x 29" 29.39" x 29.39"	24" x 47" 23.5" x 47.09"	15" x 29" 14.65" x 29.39"	12" x 24" 11.71" x 23.5"			
Thickness	10mm	10mm	10mm	10mm			
Faces	16	8	32	32			
Finish	Matte	Matte	Matte	Matte			
Edge	Rectified	Rectified	Rectified	Rectified			
Grout Joint Recommendation	1/8"	1/8"	1/8"	1/8"			
Testing	Abrasion Resistance C1027	Breaking Strength C648	Chemical Resistance C650	Water Absorption C373	DCOF ANSI A1371	Scratch Hardness MOHS	Shade Variation Rating
	Results* IV	>700 lbf	Resistant	<0.50%	>0.60	5	V2

Product and Installation Details | ANSI A108.02
 Section 4.3.8.2 - For running bond/brick jointing patterns utilizing tiles (square or rectangular) where the side being offset is greater than 18" (nominal dimension), the running bond offset will be a maximum of 33% unless otherwise specified by the tile manufacturer. If an offset greater than 33% is specified, specifier and owner must approve mock-up and lippage.



Sustainability Attributes

- Red List Free
- Health Product Declaration (HPD) provided upon request
- Product Packaging is 100% recyclable
- VOC Free

*For more information visit www.emser.com. Always consult a professional for proper usage and installation.



The Building Blocks™ Concrete line beautifully replicates the contemporary look of concrete while bringing in an added layer of warmth and sophistication. Designed to blend perfectly with other Building Blocks™ products, as well as the Back to Basics™ collection, this line provides endless design possibilities.

BUILDING BLOCKS™ CONCRETE

Glazed Body Match Porcelain



FLOOR / WALL  RESIDENTIAL  COMMERCIAL  INDOOR 





Steel



Black



Bronze

Sizes							
	24" x 47" 23.54" x 47.17"	12" x 24" 11.73" x 23.54"					
Thickness	8.8mm	8.8mm					
Faces	12	48					
Finish	Matte	Matte					
Edge	Rectified	Rectified					
Grout Joint Recommendation	1/16"	1/16"					
Testing	Abrasion Resistance C1027	Breaking Strength C648	Chemical Resistance C650	Water Absorption C373	DCOF ANSI A1371	Scratch Hardness MOHS	Shade Variation Rating
	Results* IV	>500 lbf	Resistant	<0.50%	>0.60	6	V2

Product and Installation Details | ANSI A108.02
 Section 4.3.8.2 - For running bond/brick jointing patterns utilizing tiles (square or rectangular) where the side being offset is greater than 18" (nominal dimension), the running bond offset will be a maximum of 33% unless otherwise specified by the tile manufacturer. If an offset greater than 33% is specified, specifier and owner must approve mock-up and lippage.



 Sustainability Attributes

- Red List Free
- Health Product Declaration (HPD) provided upon request
- Product Packaging is 100% recyclable
- VOC Free

*For more information visit www.emser.com. Always consult a professional for proper usage and installation.



The Building Blocks™ Metal line strikes a harmonious balance between industrial chic and modern luxury. The rich colors are reminiscent of iron, bronze and steel and provide sophisticated elegance to any application. This porcelain tile is sure to bring any room to life.

BUILDING BLOCKS™ METAL

Glazed Porcelain



FLOOR / WALL  RESIDENTIAL  COMMERCIAL  INDOOR 



White



Sand



Gray

Sizes Thickness Faces Finish Edge Grout Joint Recommendation							
	8" x 47" 778" x 479"						
	10mm						
	40						
	Matte						
	Rectified						
3/16"							
Testing	Abrasion Resistance C1027	Breaking Strength C648	Chemical Resistance C650	Water Absorption C373	DCOF ANSI A1371	Scratch Hardness MOHS	Shade Variation Rating
Results*	IV	>650 lbf	Resistant	<0.50%	>0.50	6	V2

Product and Installation Details | ANSI A108.02
 Section 4.3.8.2 - For running bond/brick jointing patterns utilizing tiles (square or rectangular) where the side being offset is greater than 18" (nominal dimension), the running bond offset will be a maximum of 33% unless otherwise specified by the tile manufacturer. If an offset greater than 33% is specified, specifier and owner must approve mock-up and lippage.



Sustainability Attributes

- Red List Free
- Health Product Declaration (HPD) provided upon request
- Product Packaging is 100% recyclable
- VOC Free



*For more information visit www.emser.com. Always consult a professional for proper usage and installation.

The Building Blocks™ Wood line provides the warmth and sophistication of wood in a durable porcelain tile. Designed to blend perfectly with other Building Blocks™ products, this line provides a stylized re-creation of natural elements that create a harmonious blend of textures and sizes.

BUILDING BLOCKS™ WOOD | OAK

Glazed Porcelain



FLOOR / WALL



RESIDENTIAL



INDOOR



OUTDOOR



Black



Navy



Charcoal



Silver



Ivory

Sizes Thickness Faces Finish Edge Grout Joint Recommendation							
	8" x 47" 7.74" x 46.85"						
	10mm						
	36						
	Matte						
	Rectified						
3/16"							
Testing	Abrasion Resistance <small>C1027</small>	Breaking Strength <small>C648</small>	Chemical Resistance <small>C650</small>	Water Absorption <small>C373</small>	DCOF ANSI <small>A1371</small>	Scratch Hardness MOHS	Shade Variation Rating
Results*	II	>700 lbf	Resistant	<0.50%	>0.50	7	V2

Product and Installation Details | ANSI A108.02
 Section 4.3.8.2 - For running bond/brick joint patterns utilizing tiles (square or rectangular) where the side being offset is greater than 18" (nominal dimension), the running bond offset will be a maximum of 33% unless otherwise specified by the tile manufacturer. If an offset greater than 33% is specified, specifier and owner must approve mock-up and lippage.



Sustainability Attributes

- Red List Free
- Health Product Declaration (HPD) provided upon request
- Product Packaging is 100% recyclable
- VOC Free

*For more information visit www.emser.com. Always consult a professional for proper usage and installation.



Yakedo™ replicates the sophisticated aesthetic of burnt cedar in a durable glazed porcelain plank tile. Based on the Shou Sugi Ban technique, or slight burning before installation, the worn textures create a certain dimension and strength. The way in which it reflects light from its crackled texture brings sophisticated movement and visual intrigue to interiors.

BUILDING BLOCKS™ WOOD | YAKEDO™

Glazed Body Match Porcelain



FLOOR / WALL  RESIDENTIAL  COMMERCIAL  INDOOR  OUTDOOR 



Denali



Sequoia



Yosemite



Zion

Sizes Thickness Faces Finish Edge Grout Joint Recommendation							
	6" x 24" 5.91" x 23.62"						
	9mm						
	6						
	Matte						
	Pressed						
Testing	Abrasion Resistance C1027	Breaking Strength C648	Chemical Resistance C650	Water Absorption C373	DCOF ANSI A1371	Scratch Hardness MOHS	Shade Variation Rating
Results*	IV	>375 lbf	Resistant	<0.50%	>0.45	7	V3

Product and Installation Details | ANSI A108.02
 Section 4.3.8.2 - For running bond/brick jointing patterns utilizing tiles (square or rectangular) where the side being offset is greater than 18" (nominal dimension), the running bond offset will be a maximum of 33% unless otherwise specified by the tile manufacturer. If an offset greater than 33% is specified, specifier and owner must approve mock-up and lippage.



 Sustainability Attributes

- Red List Free
- Health Product Declaration (HPD) provided upon request
- Product Packaging is 100% recyclable
- VOC Free

*For more information visit www.emser.com. Always consult a professional for proper usage and installation.



Cabin™ beautifully replicates the subtle look of wood in durable glazed porcelain tile. Offered in neutral earthy colors to compliment your space.

CABIN™
Glazed Porcelain



FLOOR / WALL  RESIDENTIAL  COMMERCIAL  INDOOR 



Shore

Coast

Ocean





Mosaics



Shore

Coast

Ocean

Sizes							
	17" x 17" 17.26" x 17.26"	13" x 13" 12.99" x 12.99"	12" x 24"	13" x 13" Mesh 13.11" x 13.11"	3" x 12" Floor SBN		
Thickness	9mm	8mm	Check Website	7.7mm	Check Website		
Faces	20	20	Check Website	N/A	N/A		
Finish	Matte	Matte	Matte	Matte	Matte		
Edge	Pressed	Pressed	Pressed	Cut	Cut/Rounded		
Grout Joint Recommendation	3/16"	3/16"	3/16"	3/16"	3/16"		
Testing	Abrasion Resistance C1027	Breaking Strength C648	Chemical Resistance C650	Water Absorption C373	DCOF ANSI A1371	Scratch Hardness MOHS	Shade Variation Rating
	III	>250 lbf	Resistant	>7.0%	<0.42	7	V2

 Sustainability Attributes

- Red List Free
- Health Product Declaration (HPD) provided upon request
- Product Packaging is 100% recyclable
- VOC Free

*For more information visit www.emser.com. Always consult a professional for proper usage and installation.

Cabo™ features crackled, subtle movement to emulate the details of natural travertine. Colors of warm and cool neutrals reflect a relaxed, coastal feel. Varied tile sizes invite a range of applications.

CABO™
Glazed Ceramic



FLOOR / WALL  RESIDENTIAL  COMMERCIAL  INDOOR  OUTDOOR 



White





Gray



Moka



Black

Sizes							
	24" x 47" 23.62" x 47.24"	12" x 24" 11.81" x 23.62"	3" x 12" Floor SBN				
Thickness	10mm	10mm	10mm				
Faces	4	16	N/A				
Finish	Matte	Matte	Matte				
Edge	Rectified	Rectified	Rectified				
Grout Joint Recommendation	3/16"	3/16"	3/16"				
Testing	Abrasion Resistance C1027	Breaking Strength C648	Chemical Resistance C650	Water Absorption C373	DCOF ANSI A1371	Scratch Hardness MOHS	Shade Variation Rating
	Results* IV	>450 lbf	Resistant	<0.5%	>0.55	6	V2

Product and Installation Details | ANSI A108.02
Section 4.3.8.2 - For running bond/brick joining patterns utilizing tiles (square or rectangular) where the side being offset is greater than 18" (nominal dimension), the running bond offset will be a maximum of 33% unless otherwise specified by the tile manufacturer. If an offset greater than 33% is specified, specifier and owner must approve mock-up and lippage.



 Sustainability Attributes

- Red List Free
- Health Product Declaration (HPD) provided upon request
- Product Packaging is 100% recyclable
- VOC Free

*For more information visit www.emser.com. Always consult a professional for proper usage and installation.

Cassero II™ offers a rustic and refined concrete linear texture in glazed porcelain. The matte finish is offered in colors complementing each other and is suitable for interior and exterior applications.

CASSERO II™

Glazed Porcelain



FLOOR / WALL  RESIDENTIAL  COMMERCIAL  INDOOR  OUTDOOR  POOL 



Atolia



Carson



Jerome



Kismet



Loring

Mosaics



Atolia

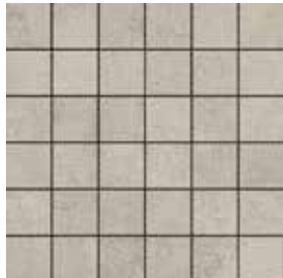

Carson



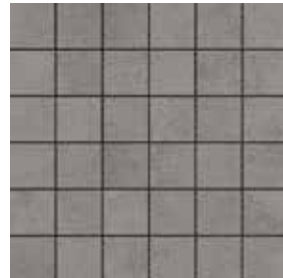

Jerome

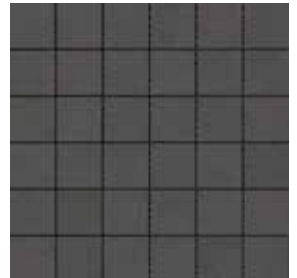

Kismet



Loring

Sizes							
	12"x24" 11.81"x23.62"	12"x12" Mesh	3"x12" Floor SBN				
Thickness	9mm	9.1mm	9mm				
Faces	12	N/A	N/A				
Finish	Matte	Matte	Matte				
Edge	Rectified	Cut	Cut/Rounded				
Grout Joint Recommendation	3/16"	3/16"	3/16"				
Testing	Abrasion Resistance C1027	Breaking Strength C648	Chemical Resistance C650	Water Absorption C373	DCOF ANSI A1371	Scratch Hardness MOHS	Shade Variation Rating
	III	>250 lbf	Resistant	<0.50%	>0.60	7	V3

Product and Installation Details | ANSI A108.02
Section 4.3.8.2 - For running bond/brick jointing patterns utilizing tiles (square or rectangular) where the side being offset is greater than 18" (nominal dimension), the running bond offset will be a maximum of 33% unless otherwise specified by the tile manufacturer. If an offset greater than 33% is specified, specifier and owner must approve mock-up and lippage.



 Sustainability Attributes

- Red List Free
- Health Product Declaration (HPD) provided upon request
- Product Packaging is 100% recyclable
- VOC Free
- 0% Pre- and Post-Consumer

*For more information visit www.emser.com. Always consult a professional for proper usage and installation.

Chiado II™ brings the subtlety of cement to new form in porcelain tile. Neutral tones result in a cool, contemporary surface to allow various applications and creative layouts.

CHIADO II™

Glazed Porcelain





Era



Memoir

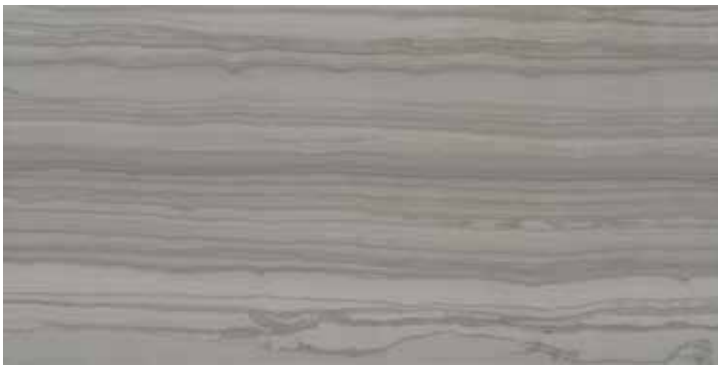

Record

Mosaics



Era



Memoir



Record

Sizes							
	12"x24" 11.81"x23.62"	12"x12" Mesh 11.69"x11.69"	3"x24" Floor SBN				
Thickness	9.8mm	9.8mm	9.8mm				
Faces	16	N/A	N/A				
Finish	Matte	Matte	Matte				
Edge	Pressed	Cut	Cut/Rounded				
Grout Joint Recommendation	3/16"	3/16"	3/16"				
Testing	Abrasion Resistance C1027	Breaking Strength C648	Chemical Resistance C650	Water Absorption C373	DCOF ANSI A1371	Scratch Hardness MOHS	Shade Variation Rating
	Results* IV	≥850 lbf	Resistant	≤0.5%	≥0.60	7	V2

Product and Installation Details | ANSI A108.02
 Section 4.3.8.2 - For running bond/brick jointing patterns utilizing tiles (square or rectangular) where the side being offset is greater than 18" (nominal dimension), the running bond offset will be a maximum of 33% unless otherwise specified by the tile manufacturer. If an offset greater than 33% is specified, specifier and owner must approve mock-up and lippage.



Sustainability Attributes

- Red List Free
- Health Product Declaration (HPD) provided upon request
- Product Packaging is 100% recyclable
- VOC Free

*For more information visit www.emser.com. Always consult a professional for proper usage and installation.

Chronicle™ is inspired by the universal luxury of veincut marble. Light-toned colors with high-definition variation complement any decor. Era and Memoir colors are available in a polished finish in our Archive™ series.

CHRONICLE™

Glazed Porcelain



FLOOR / WALL  RESIDENTIAL  COMMERCIAL  INDOOR  OUTDOOR 



Civilian



Elector



Public



Resident



Subject

Mosaics



Civilian



Elector

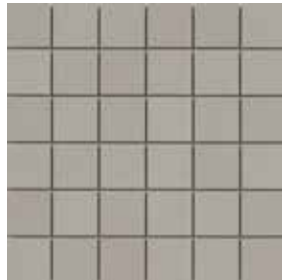



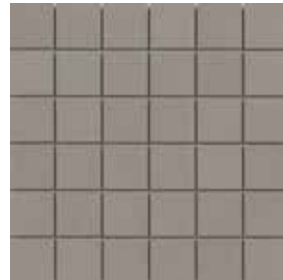



Public



Resident



Subject

Sizes Thickness Faces Finish Edge Grout Joint Recommendation							
	24" x 48" 23.62" x 47.24"	24" x 24" 23.62" x 23.62"	12" x 24" 11.81" x 23.62"	12" x 12" Mesh	3" x 12" Floor SBN	6" x 12" Cove Base	1" x 6" Cove Base Corner Out
	10mm	10mm	10mm	10mm	10mm	10mm	10mm
	12	15	30	N/A	N/A	20	20
	Matte & Lappato	Matte & Lappato	Matte & Lappato	Matte	Matte	Matte	Matte
	Rectified	Rectified	Rectified	Cut	Cut/Rounded	Rectified	Rectified
	1/8"	1/8"	1/8"	1/8"	1/8"	1/8"	1/8"
Testing	Abrasion Resistance C1027	Breaking Strength C648	Chemical Resistance C650	Water Absorption C373	DCOF ANSI A1371	Scratch Hardness MOHS	Shade Variation Rating
Results*	III	>500 lbf	Resistant	≤0.50%	≥0.65 (M) ≥0.50 (LP)	8	V2

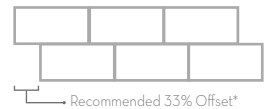

 Sustainability Attributes

- Red List Free
- Health Product Declaration (HPD) provided upon request
- Product Packaging is 100% recyclable
- VOC Free

*For more information visit www.emser.com. Always consult a professional for proper usage and installation.

In a return to form, Citizen™ embraces large format tiles and complementary mosaics. The timelessly classic concrete look is expressed through subtle brushed color variations of tans and grays. Visually arresting, Citizen™ achieves an unencumbered chic aesthetic on floors, walls, and a wide array of surfaces.

CITIZEN™

Glazed Body Match Porcelain



FLOOR / WALL  RESIDENTIAL  COMMERCIAL  INDOOR 



Ash



Cream



Taupe



Gray

Mosaics



Ash



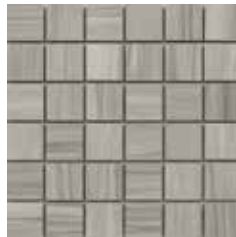

Cream



Taupe

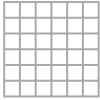

Gray

Sizes							
	12"x24" 11.81"x23.62"	12"x12" Mesh 11.82"x11.82"	3"x12" Floor SBN				
Thickness	10.5mm	10.3mm	10.5mm				
Faces	12	N/A	N/A				
Finish	Matte	Matte	Matte				
Edge	Pressed	Cut	Cut/Rounded				
Grout Joint Recommendation	3/16"	3/16"	3/16"				
Testing	Abrasion Resistance C1027	Breaking Strength C648	Chemical Resistance C650	Water Absorption C373	DCOF ANSI A1371	Scratch Hardness MOHS	Shade Variation Rating
	III	>450 lbf	Non-Resistant	≤7.0%	≥0.42	7	V2

Product and Installation Details | ANSI A108.02
 Section 4.3.8.2 - For running bond/brick jointing patterns utilizing tiles (square or rectangular) where the side being offset is greater than 18" (nominal dimension), the running bond offset will be a maximum of 33% unless otherwise specified by the tile manufacturer. If an offset greater than 33% is specified, specifier and owner must approve mock-up and lippage.



 Sustainability Attributes

- Red List Free
- Health Product Declaration (HPD) provided upon request
- Product Packaging is 100% recyclable
- VOC Free

*For more information visit www.emser.com. Always consult a professional for proper usage and installation.

Ciudad™ recreates the look of natural stone in ceramic tile using high-definition printing. Its pattern variation from tile to tile is due to its striking graphic imaging, which adds a contemporary statement to any application.

CIUDAD™
Glazed Ceramic



FLOOR / WALL  RESIDENTIAL  COMMERCIAL  INDOOR  OUTDOOR 



Dama



Oro

Mosaics



Dama

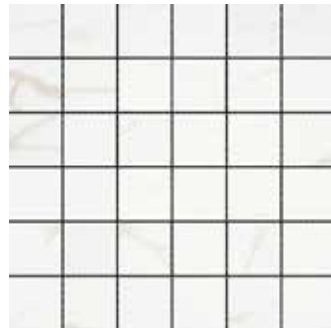













Oro



Dama



Oro

Sizes											
	24" x 24" 23.82" x 23.82"	23" x 23" 23.43" x 23.43"	18" x 18" 17.72" x 17.72"	13" x 13" 12.99" x 12.99"	12" x 24" 11.81" x 23.62"	11" x 23" 11.42" x 23.23"	3" x 6" 2.95" x 5.91"	13" x 13" Mesh 12.60" x 12.60"	Herringbone Mesh	3" x 13" Floor SBN	3" x 11" Floor SBN
Thickness	10mm	10mm	8.6mm	7.8mm	9mm	10mm	9-10mm	8.3mm	8.3mm	8.3mm	9.5mm
Faces	10	10	9	10	20	20	>100	N/A	N/A	N/A	N/A
Finish	Matte	Polished	Matte	Matte	Matte	Polished	Matte & Polished	Matte	Matte	Matte	Polished
Edge	Pressed	Rectified	Pressed	Pressed	Pressed	Rectified	Rectified	Cut	Cut	Rectified	Rectified
Grout Joint Recommendation	3/16"	3/16"	3/16"	3/16"	3/16"	3/16"	3/16"	5/32"	3/16"	3/16"	3/16"
Testing	Abrasion Resistance C1027	Breaking Strength C648	Chemical Resistance C650	Water Absorption C373	DCOF ANSI A1371	Scratch Hardness MOHS	Shade Variation Rating				
	Results* IV	>350 lbf	Resistant	<0.5%	>0.50	7	V2	 <p>Recommended 33% Offset*</p>			

Sustainability Attributes

- Red List Free
- Health Product Declaration (HPD) provided upon request
- Product Packaging is 100% recyclable
- VOC Free
- Recycled Content 34% Pre-Consumer and 0% Post-Consumer

*For more information visit www.emser.com. Always consult a professional for proper usage and installation.

Pure, simple, relaxing, Contessa™ is a true jewel adding timeless style to any space. Inspired by the exquisite veining in marble, this line is offered in multiple sizes

CONTESSA™

Glazed Porcelain



FLOOR / WALL  RESIDENTIAL  COMMERCIAL  INDOOR 



Bianco

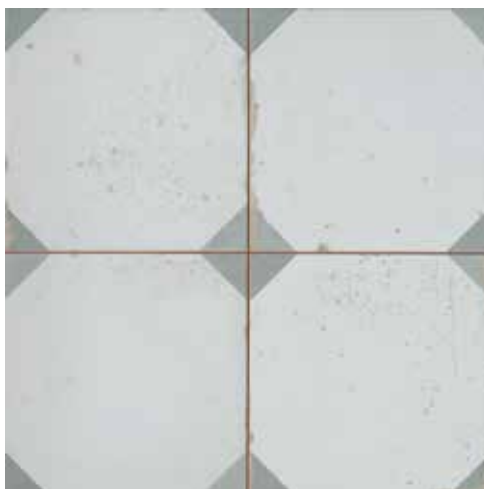

Octagon Gray



Octagon Chocolate

Sizes  18" x 18" 17.72" x 17.72" Thickness 10.5mm Faces 8 Finish Matte Edge Pressed Grout Joint Recommendation 1/16"								
	Testing	Abrasion Resistance C1027	Breaking Strength C648	Chemical Resistance C650	Water Absorption C373	DCOF ANSI A1371	Scratch Hardness MOHS	Shade Variation Rating
	Results*	IV	>375 lbf	Resistant	3.0-7.0%	>0.42	6	V1

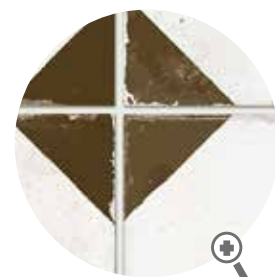

Scored Tile

- Pre-scoring provides a consistent design and easy installation.
- Apply grout directly over the scored tile lines. Fusion Pro grout is recommended.
- Scored lines have a grout width of 1/16".
- Gives the impression of a 9"x9" tile install.
- Great for walls and backsplash applications!

 Sustainability Attributes

- Red List Free
- Health Product Declaration (HPD) provided upon request
- Product Packaging is 100% recyclable
- VOC Free
- 7-10% Pre-Consumer

*For more information visit www.emser.com. Always consult a professional for proper usage and installation.

The style and name of Cortijo™ is derived from courtyards in the south of Spain. The unique scored design of this 18x18 ceramic floor and wall tile provides the illusion of multiple tiles, but installs with the ease of one. The cool color tone and hexagon styling fits well with both traditional and contemporary designs.

CORTIJO™

Glazed Ceramic





Crystal



Ecreu



Steel

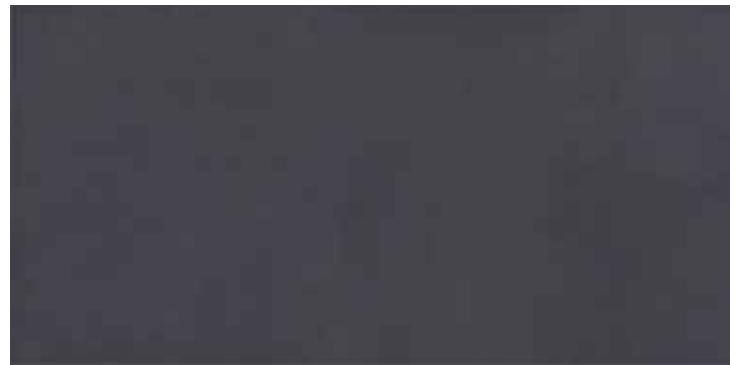

Charcoal

Mosaics



Crystal

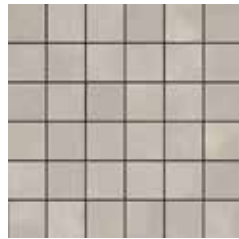

Ecreu



Steel



Charcoal

Sizes							
	24" x 24" 23.62" x 23.62"	12" x 24" 11.81" x 23.62"	13" x 13" Mesh 13.07" x 13.07"	3" x 12" Floor SBN			
Thickness	9.8mm	9.8mm	7.2mm	9.8mm			
Faces	5	10	N/A	N/A			
Finish	Matte	Matte	Matte	Matte			
Edge	Pressed	Pressed	Cut	Cut/Rounded			
Grout Joint Recommendation	3/16"	3/16"	3/16"	3/16"			
Testing	Abrasion Resistance C1027	Breaking Strength C648	Chemical Resistance C650	Water Absorption C373	DCOF ANSI A1371	Scratch Hardness MOHS	Shade Variation Rating
	IV	≥250 lbf	Resistant	≤0.50%	≥0.60	7	V3

Product and Installation Details | ANSI A108.02
 Section 4.3.8.2 - For running bond/brick joining patterns utilizing tiles (square or rectangular) where the side being offset is greater than 18" (nominal dimension), the running bond offset will be a maximum of 33% unless otherwise specified by the tile manufacturer. If an offset greater than 33% is specified, specifier and owner must approve mock-up and lippage.



Sustainability Attributes

- Red List Free
- Health Product Declaration (HPD) provided upon request
- Product Packaging is 100% recyclable
- VOC Free

*For more information visit www.emser.com. Always consult a professional for proper usage and installation.

Cosmopolitan™ is an artful recreation of brushed concrete. Rich colors elevate urban living with modern sensibility. An approachable matte finish allows the collection to complement a range of aesthetics.

COSMOPOLITAN™

Glazed Porcelain



FLOOR / WALL  RESIDENTIAL  COMMERCIAL  INDOOR  OUTDOOR  POOL 

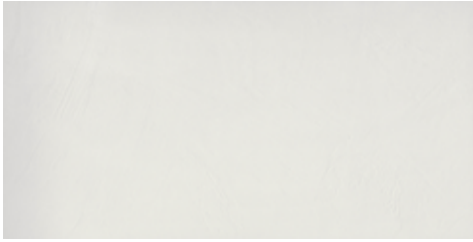

Ivory



Silver



Gray



Olive



Black

Mosaics

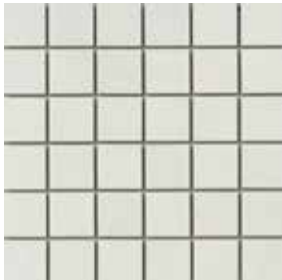

Ivory

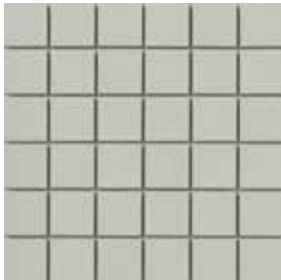

Silver

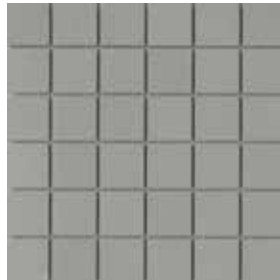



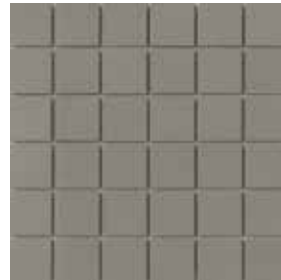

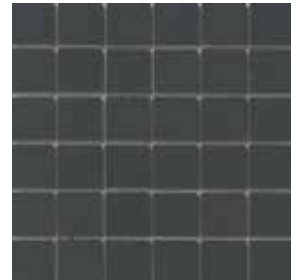

Gray



Olive

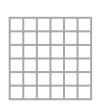

Black

Sizes							
	24" x 24" 23.62" x 23.62"	12" x 24" 11.81" x 23.62"	12" x 12" Mesh 12.28" x 12.28"	3" x 12" Floor SBN	6" x 12" Cove Base	1" x 6" Cove Base Corner Out	
Thickness	8mm	8.5mm	7.4mm	9mm	N/A	N/A	
Faces	6 2 Textures	12 3 Textures	N/A	N/A	N/A	N/A	
Finish	Matte	Matte	Matte	Matte	Matte	Matte	
Edge	Rectified	Rectified	Rectified	Cut/Rounded	Pressed	Pressed	
Grout Joint Recommendation	1/8"	1/8"	1/8"	1/8"	1/8"	1/8"	
Testing	Abrasion Resistance C1027	Breaking Strength C648	Chemical Resistance C650	Water Absorption C373	DCOF ANSI A1371	Scratch Hardness MOHS	Shade Variation Rating
Results*	IV	>385 lbf	Resistant	<0.50%	>0.60	7	V1

Product and Installation Details | ANSI A108.02 Section 4.3.8.2 - For running bond/brick joining patterns utilizing tiles (square or rectangular) where the side being offset is greater than 18" (nominal dimension), the running bond offset will be a maximum of 33% unless otherwise specified by the tile manufacturer. If an offset greater than 33% is specified, specifier and owner must approve mock-up and lippage.



Sustainability Attributes

- Red List Free
- Health Product Declaration (HPD) provided upon request
- Product Packaging is 100% recyclable
- VOC Free

*For more information visit www.emser.com. Always consult a professional for proper usage and installation.

Council™ offers a modern and fashionable approach to floor and wall applications. With a nod to leather, this series is available in five cool tones that were designed to mix and match to create stunning environments.

COUNCIL™

Glazed Porcelain



FLOOR / WALL  RESIDENTIAL  COMMERCIAL  INDOOR  OUTDOOR 



Atar



Nador



Tripoli



Zilla

Mosaics

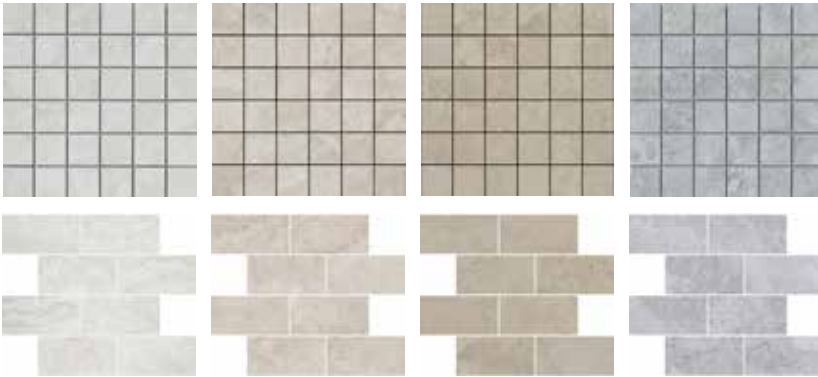





Atar

Nador

Tripoli

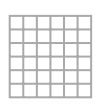
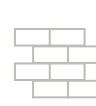
Zilla

Sizes							
	17" x 17" 16.73" x 16.73"	13" x 13" 12.99" x 12.99"	12" x 24" 12.20" x 24.02"	13" x 13" Mesh 12.60" x 12.60"	12" x 12" Mesh 11.61" x 11.69"	3" x 13" Floor SBN	
Thickness	8.5mm	8mm	9mm	8.5mm	9.5mm	8mm	
Faces	20	20	20	N/A	N/A	N/A	
Finish	Matte	Matte	Matte	Matte	Matte	Matte	
Edge	Pressed	Pressed	Pressed	Cut	Cut	Cut/Rounded	
Grout Joint Recommendation	3/16"	3/16"	3/16"	3/16"	3/16"	3/16"	
Testing	Abrasion Resistance C1027	Breaking Strength C648	Chemical Resistance C650	Water Absorption C373	DCOF ANSI A1371	Scratch Hardness MOHS	Shade Variation Rating
	III	>450 lbf	Resistant	<0.50%	>0.50	8	V3

Product and Installation Details | ANSI A108.02
Section 4.3.8.2 - For running bond/brick jointing patterns utilizing tiles (square or rectangular) where the side being offset is greater than 18" (nominal dimension), the running bond offset will be a maximum of 33% unless otherwise specified by the tile manufacturer. If an offset greater than 33% is specified, specifier and owner must approve mock-up and lippage.



 Sustainability Attributes

- Red List Free
- Health Product Declaration (HPD) provided upon request
- Product Packaging is 100% recyclable
- VOC Free

*For more information visit www.emser.com. Always consult a professional for proper usage and installation.



Daroca™ brings the warmth of nature into a modern porcelain tile. Inspired by the look of travertine in warm and cool tones, Daroca™ is ideal for any application.

DAROCA™
Glazed Porcelain

FLOOR / WALL  RESIDENTIAL  COMMERCIAL  INDOOR  OUTDOOR 



Astoria



Harlem



Soho



Tribeca

Mosaics



Astoria







Harlem



Soho



Tribeca

Sizes							
	12" x 24" 12.01" x 24.02"	9" x 36" 8.96" x 36.02"	12" x 12" Mesh 11.75" x 11.75"	3" x 12" Floor SBN			
Thickness	8.2mm	9.2mm	7.8mm	8.2mm			
Faces	12	12	12	12			
Finish	Matte	Matte	Matte	Matte			
Edge	Pressed	Pressed	Rectified	Cut/Rounded			
Grout Joint Recommendation	3/16"	3/16"	3/16"	3/16"			
Testing	Abrasion Resistance C1027	Breaking Strength C648	Chemical Resistance C650	Water Absorption C373	DCOF ANSI A1371	Scratch Hardness MOHS	Shade Variation Rating
	IV	>325 lbf	Resistant	<0.50%	>0.42	7	V2

Product and Installation Details | ANSI A108.02
Section 4.3.8.2 - For running bond/brick joining patterns utilizing tiles (square or rectangular) where the side being offset is greater than 18" (nominal dimension), the running bond offset will be a maximum of 33% unless otherwise specified by the tile manufacturer. If an offset greater than 33% is specified, specifier and owner must approve mock-up and lippage.



 Sustainability Attributes

- Red List Free
- Health Product Declaration (HPD) provided upon request
- Product Packaging is 100% recyclable
- VOC Free
- 40% Pre-Consumer

*For more information visit www.emser.com. Always consult a professional for proper usage and installation.



Denova™ replicates the look of concrete with cool tones and a brushed linear texture. Available in four colors.

DENOVA™

Glazed Porcelain



FLOOR / WALL  RESIDENTIAL  COMMERCIAL  INDOOR  OUTDOOR 



Mural



Outline



Sketch



Diagram

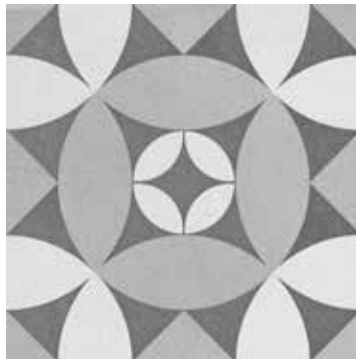

Portrait



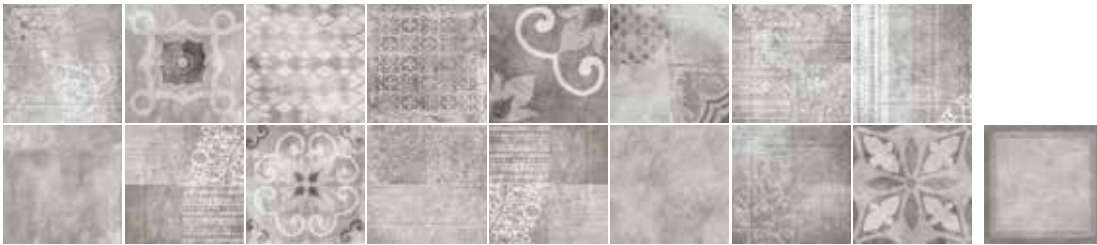

Art



Art Faces

Art has 18 patterns, intended for random installations or accent pieces.

Sizes							
	9" x 9" 9.17" x 9.17"	9" x 9" 9.17" x 9.17"					
Thickness	8.5mm	8.5mm					
Faces	1	18 (Art)					
Finish	Matte	Matte					
Edge	Pressed	Pressed					
Grout Joint Recommendation	1/8"	1/8"					
Testing	Abrasion Resistance C1027	Breaking Strength C648	Chemical Resistance C650	Water Absorption C373	DCOF ANSI A1371	Scratch Hardness MOHS	Shade Variation Rating
	Results* IV	≥700 lbf	Resistant	≤0.50%	≥0.60	7	V1

 Sustainability Attributes

- Red List Free
- Health Product Declaration (HPD) provided upon request
- Product Packaging is 100% recyclable
- VOC Free

*For more information visit www.emser.com. Always consult a professional for proper usage and installation.

Design™ is an eclectic collection of unique patterns from a distressed look with a contemporary flair to geometric patterns, offering a wide range of solutions for any space.

DESIGN™

Glazed Porcelain



FLOOR / WALL  RESIDENTIAL  COMMERCIAL  INDOOR  OUTDOOR 

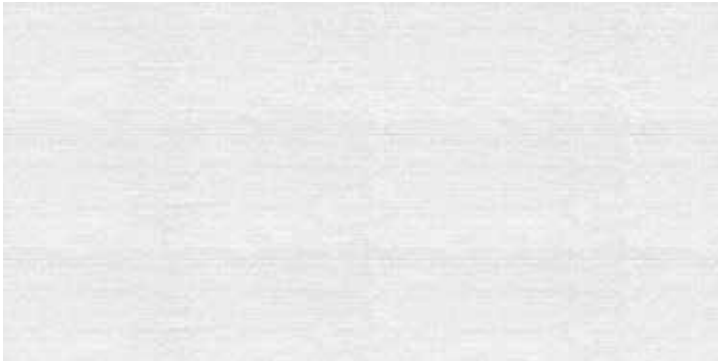

Bukhara



Orcha



Rajmata



Pattern

Mosaics

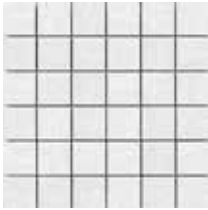

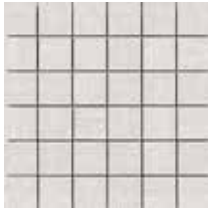

Bukhara

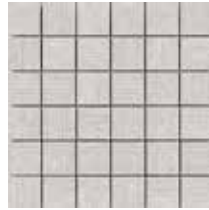

Orcha



Rajmata

Sizes							
	12"x23" 11.60"x23.43"	12"x12" Mesh 11.65"x11.65"	3"x12" Floor SBN				
Thickness	10mm	10mm	10mm				
Faces	18	N/A	N/A				
Finish	Matte/Textured	Matte/Textured	Matte/Textured				
Edge	Rectified	Cut	Cut/Rounded				
Grout Joint Recommendation	1/8"	5/64"	5/64"				
Testing	Abrasion Resistance C1027	Breaking Strength C648	Chemical Resistance C650	Water Absorption C373	DCOF ANSI A1371	Scratch Hardness MOHS	Shade Variation Rating
	Results* V	≥500 lbf	Resistant	≤0.50%	≥0.45	9	V1

Product and Installation Details | ANSI A108.02
Section 4.3.8.2 - For running bond/brick jointing patterns utilizing tiles (square or rectangular) where the side being offset is greater than 18" (nominal dimension), the running bond offset will be a maximum of 33% unless otherwise specified by the tile manufacturer. If an offset greater than 33% is specified, specifier and owner must approve mock-up and lippage.



 Sustainability Attributes

- Red List Free
- Health Product Declaration (HPD) provided upon request
- Product Packaging is 100% recyclable
- VOC Free
- Recycled Content >8% Pre-Consumer

*For more information visit www.emser.com. Always consult a professional for proper usage and installation.



Dunham™ is inspired by the timeless look of Italian menswear. Dashing linear pattern brings geometric movement, while neutral, textured designs serve minimalist styles.

DUNHAM™

Glazed Porcelain



FLOOR / WALL  RESIDENTIAL  COMMERCIAL  INDOOR  OUTDOOR 



Glacier



Rock



Valley



Wind

Mosaics



Glacier

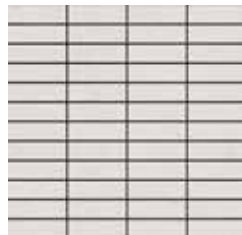



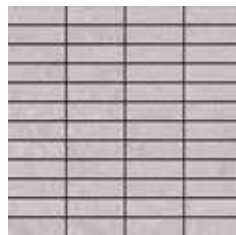

Rock



Valley

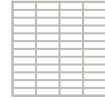

Wind

Sizes							
	20" x 20" 19.57" x 19.57"	13" x 13" 12.99" x 12.99"	12" x 24" 11.81" x 23.62"	12" x 12" Mesh	3" x 12" Floor SBN		
Thickness	8.5mm	7.1mm	8.4mm	Check Webiste	Check Webiste		
Faces	16	20	16	N/A	N/A		
Finish	Matte	Matte	Matte	Matte	Matte		
Edge	Pressed	Pressed	Pressed	Cut	Cut		
Grout Joint Recommendation	3/16"	3/16"	3/16"	Check Webiste	Check Webiste		
Testing	Abrasion Resistance C1027	Breaking Strength C648	Chemical Resistance C650	Water Absorption C373	DCOF ANSI A1371	Scratch Hardness MOHS	Shade Variation Rating
	IV	>350 lbf (12x24, 20x20) >250 lbf (13x13)	Resistant	<0.50%	>0.55	9	V2

Product and Installation Details | ANSI A108.02
Section 4.3.8.2 - For running bond/brick joining patterns utilizing tiles (square or rectangular) where the side being offset is greater than 18" (nominal dimension), the running bond offset will be a maximum of 33% unless otherwise specified by the tile manufacturer. If an offset greater than 33% is specified, specifier and owner must approve mock-up and lippage.



 Sustainability Attributes

- Red List Free
- Health Product Declaration (HPD) provided upon request
- Product Packaging is 100% recyclable
- VOC <0.5 mg/m³
- Recycled Content 3-4% Pre-Consumer and 72% Post-Consumer for Packaging Cartons

*For more information visit www.emser.com. Always consult a professional for proper usage and installation.

Earthy hues in both cool and warm tones, like those available from Erosion™ porcelain tile collection, remain the standard in interiors and exteriors. Their aesthetic appeal, coupled with the durability of tile, makes for a strong foundation in design. Available in three sizes and four colors, Erosion features the beauty found in nature.

EROSION™

Glazed Porcelain



FLOOR / WALL  RESIDENTIAL  COMMERCIAL  INDOOR  OUTDOOR 



Alley



Hall



Pass



Trail

Mosaics



Alley









Hall



Pass



Trail

Sizes							
	17" x 35" 17.40" x 35.01"	12" x 24" 11.81" x 23.62"	11" x 23" 11.42" x 23.23"	12" x 12" Mesh 11.81" x 11.81"	3" x 12" (M) Floor SBN	3" x 11" (P) Floor SBN	
Thickness	11mm	9.8mm	10mm	9.8mm	9.5mm	10mm	
Faces	5	16	16	N/A	N/A	N/A	
Finish	Matte	Matte	Polished	Matte	Matte	Polished	
Edge	Rectified	Pressed	Rectified	Cut	Cut/Rounded	Cut/Rounded	
Grout Joint Recommendation	3/16"	3/16"	3/16"	3/16"	3/16"	3/16"	
Testing	Abrasion Resistance C1027	Breaking Strength C648	Chemical Resistance C650	Water Absorption C373	DCOF ANSI A1371	Scratch Hardness MOHS	Shade Variation Rating
Results*	III	≥600 lbf	Resistant	≤0.50%	≥0.60	9	V2

Product and Installation Details | ANSI A108.02
Section 4.3.8.2 - For running bond/brick jointing patterns utilizing tiles (square or rectangular) where the side being offset is greater than 18" (nominal dimension), the running bond offset will be a maximum of 33% unless otherwise specified by the tile manufacturer. If an offset greater than 33% is specified, specifier and owner must approve mock-up and lippage.



 Sustainability Attributes

- Red List Free
- Health Product Declaration (HPD) provided upon request
- Product Packaging is 100% recyclable
- VOC Free

*For more information visit www.emser.com. Always consult a professional for proper usage and installation.

Esplanade™ embodies the earthy aesthetic of travertine in a durable porcelain tile. Nuanced color variation lends a natural aesthetic. Large format and mosaic tiles allow for a range of design applications.

ESPLANADE™

Glazed Porcelain



FLOOR / WALL  RESIDENTIAL  COMMERCIAL  INDOOR  OUTDOOR 



Bianco



Cafe



Chiara



Grigio



Noce

Mosaics



Bianco



Cafe





Chiara



Grigio

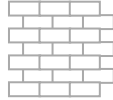

Noce

Sizes							
	12"x24" 11.80"x23.60"	13"x13" Mesh 12.69"x12.69"	3"x12" Floor SBN				
Thickness	9.8mm	8mm	9.8mm				
Faces	8	N/A	N/A				
Finish	Matte	Matte	Matte				
Edge	Pressed	Cut	Cut/Rounded				
Grout Joint Recommendation	3/16"	3/16"	3/16"				
Testing	Abrasion Resistance C1027	Breaking Strength C648	Chemical Resistance C650	Water Absorption C373	DCOF ANSI A1371	Scratch Hardness MOHS	Shade Variation Rating
	Results* V	≥350 lbf	Resistant	≤0.50%	>0.42	7	V3

Product and Installation Details | ANSI A108.02
Section 4.3.8.2 - For running bond/brick jointing patterns utilizing tiles (square or rectangular) where the side being offset is greater than 18" (nominal dimension), the running bond offset will be a maximum of 33% unless otherwise specified by the tile manufacturer. If an offset greater than 33% is specified, specifier and owner must approve mock-up and lippage.



 Sustainability Attributes

- Red List Free
- Health Product Declaration (HPD) provided upon request
- Product Packaging is 100% recyclable
- VOC Free

*For more information visit www.emser.com. Always consult a professional for proper usage and installation.

Eurasia™ interprets the dramatic design statement of imported stone through striking graphic imagery. Layered segments of tonal neutrals bring visual depth and flair. A timeless color palette allows for a range of applications.

EURASIA™
Glazed Porcelain





Arabescato White



Lazio White



Onix White

Sizes Thickness Faces Finish Edge Grout Joint Recommendation	 63" x 126" 62.91" x 125.91"						
	6.5mm						
	3	4					
	(Arabescato, Lazio) (Onix White)						
	Polished						
Rectified							
1/8"							
Testing	Deep Abrasion Resistance C1243	Breaking Strength C648	Chemical Resistance C650	Water Absorption C373	DCOF ANSI A1371	Scratch Hardness MOHS	Shade Variation Rating
Results*	1	≥250 lbf	Resistant	≤0.50%	M ≥ .60 P < .42	6	V1 - V2

Product and Installation Details | ANSI A108.02
 Section 4.3.8.2 - For running bond/brick jointing patterns utilizing tiles (square or rectangular) where the side being offset is greater than 18" (nominal dimension), the running bond offset will be a maximum of 33% unless otherwise specified by the tile manufacturer. If an offset greater than 33% is specified, specifier and owner must approve mock-up and lippage.



Sustainability Attributes

- Red List Free
- Health Product Declaration (HPD) provided upon request
- Product Packaging is 100% recyclable
- VOC Free
- Recycled content varies by color, please check website for updated information.

*For more information visit www.emser.com. Always consult a professional for proper usage and installation.



The flexibility of Expanse™ gives an elegant look to surfaces for commercial and residential interior and exterior installations. This beautiful and unique large format tile offers a seamless look to floors and walls.

EXPANSE™
Glazed & Thin Tile Porcelain



LARGE FORMAT  FLOOR / WALL  RESIDENTIAL  COMMERCIAL  INDOOR 



Network Gray



Network Silver



Network Taupe





Network White



Hangar Ash



Hangar Smoke

Sizes							
	63"x126" 62.91"x125.91"		63"x126" 62.91"x125.91"				
Thickness	6mm (Network)		7mm (Hangar)				
Faces	3		2				
Finish	Matte		Matte				
Edge	Rectified		Rectified				
Grout Joint Recommendation	1/8"		1/8"				
Testing	Deep Abrasion Resistance C1243	Breaking Strength C648	Chemical Resistance C650	Water Absorption C373	DCOF ANSI A1371	Scratch Hardness MOHS	Shade Variation Rating
	Results* 1	≥250 lbf	Resistant	≤0.50%	M ≥ .60 P < .42	6	V1 - V2

Product and Installation Details | ANSI A108.02
 Section 4.3.8.2 - For running bond/brick jointing patterns utilizing tiles (square or rectangular) where the side being offset is greater than 18" (nominal dimension), the running bond offset will be a maximum of 33% unless otherwise specified by the tile manufacturer. If an offset greater than 33% is specified, specifier and owner must approve mock-up and lippage.



Sustainability Attributes

- Red List Free
- Health Product Declaration (HPD) provided upon request
- Product Packaging is 100% recyclable
- VOC Free
- Recycled content varies by color, please check website for updated information.

*For more information visit www.emser.com. Always consult a professional for proper usage and installation.



The flexibility of Expanse™ gives an elegant look to surfaces for commercial and residential interior and exterior installations. This beautiful and unique large format tile offers a seamless look to floors and walls.

EXPANSE™

Glazed & Thin Tile Porcelain



FLOOR / WALL  RESIDENTIAL  COMMERCIAL  INDOOR  OUTDOOR 



Milan



London



Barcelona



Paris

Mosaics



Milan





London



Barcelona



Paris

Sizes							
	12"x24" 11.81"x23.62"	13"x13" Mesh 12.60"x12.60"					
Thickness	9mm	8mm					
Faces	18	N/A					
Finish	Matte	Matte					
Edge	Pressed	Cut					
Grout Joint Recommendation	3/16"	3/16"					
Testing	Abrasion Resistance C1027	Breaking Strength C648	Chemical Resistance C650	Water Absorption C373	DCOF ANSI A1371	Scratch Hardness MOHS	Shade Variation Rating
	Results* IV	≥300 lbf	Resistant	≤0.50%	≥0.60	7	V2

Product and Installation Details | ANSI A108.02
Section 4.3.8.2 - For running bond/brick joining patterns utilizing tiles (square or rectangular) where the side being offset is greater than 18" (nominal dimension), the running bond offset will be a maximum of 33% unless otherwise specified by the tile manufacturer. If an offset greater than 33% is specified, specifier and owner must approve mock-up and lippage.



 Sustainability Attributes

- Red List Free
- Health Product Declaration (HPD) provided upon request
- Product Packaging is 100% recyclable
- VOC Free
- Recycled Content 0% Pre-Consumer

*For more information visit www.emser.com. Always consult a professional for proper usage and installation.

Explorer™ is an artful blend of reclaimed wood and natural stone for an urban aesthetic. High-definition printing pairs wood striations with stone veining in soft, alluring neutrals.

EXPLORER™

Glazed Porcelain



FLOOR / WALL  RESIDENTIAL  COMMERCIAL  INDOOR 



White



Ivory



Gray



Taupe

Mosaics



White





Ivory



Gray



Taupe

Sizes							
	12" x 24" 11.81" x 23.62"	12" x 12" Mesh 11.81" x 11.81"	3" x 12" Floor SBN				
Thickness	10mm	10mm	10.5mm				
Faces	18	N/A	N/A				
Finish	Matte	Matte	Matte				
Edge	Pressed	Cut	Cut/Rounded				
Grout Joint Recommendation	1/8"	5/64"	1/8"				
Testing	Abrasion Resistance C1027	Breaking Strength C648	Chemical Resistance C650	Water Absorption C373	DCOF ANSI A1371	Scratch Hardness MOHS	Shade Variation Rating
	III	≥250 lbf	Resistant	≤0.50%	≥0.45	6	V1

Product and Installation Details | ANSI A108.02
Section 4.3.8.2 - For running bond/brick jointing patterns utilizing tiles (square or rectangular) where the side being offset is greater than 18" (nominal dimension), the running bond offset will be a maximum of 33% unless otherwise specified by the tile manufacturer. If an offset greater than 33% is specified, specifier and owner must approve mock-up and lippage.



 Sustainability Attributes

- Red List Free
- Health Product Declaration (HPD) provided upon request
- Product Packaging is 100% recyclable
- VOC Free

*For more information visit www.emser.com. Always consult a professional for proper usage and installation.



Facade™ combines the intricate look of canvas and plaster into a beautiful glazed porcelain tile. Available in multiple colors and coordinating mosaics, this series is sure to add character to any space.

FACADE™

Glazed Body Match Porcelain



FLOOR / WALL  RESIDENTIAL  COMMERCIAL  INDOOR 

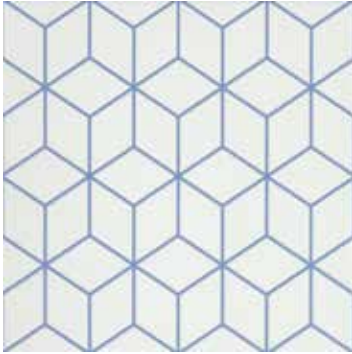

Cube Blue



Atom Blue

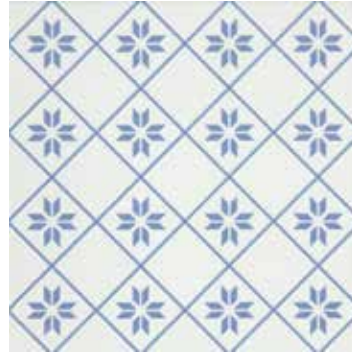

Petal Blue



Frame Navy



Cube Gray



Atom Gray



Petal Gray



Frame Gray

Sizes



10" x 10"
9.84" x 9.84"

Thickness

8,5mm

Faces

1

Finish

Matte

Edge

Pressed

Grout Joint Recommendation

3/16"

Testing

Abrasion Resistance
C1027

Breaking Strength
C648

Chemical Resistance
C650

Water Absorption
C373

DCOF ANSI
A1371

Scratch Hardness
MOHS

Shade Variation
Rating

Results*

IV

>400 lbf

Resistant

≤0.50%

≥0.42

6

V2

 Sustainability Attributes

- Red List Free
- Health Product Declaration (HPD) provided upon request
- Product Packaging is 100% recyclable
- VOC Free

*For more information visit www.emser.com. Always consult a professional for proper usage and installation.

Geometry™ takes design to a whole new level. The modern, retro flare look of Geometry™ provides an element of uniqueness not found in most tiles. The raised pattern adds interest and character and will transcend any application.

GEOMETRY™

Glazed Porcelain



FLOOR / WALL  RESIDENTIAL  COMMERCIAL  INDOOR  OUTDOOR 



Khafre



Menkaure



Pharaoh



Sphinx

Mosaics



Khafre



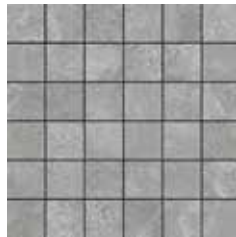

Menkaure

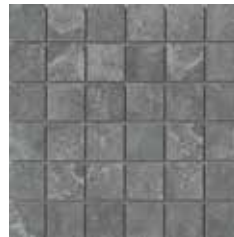

Pharaoh



Sphinx

Sizes							
	12"x24" 11.81"x23.62"	13"x13" Mesh 12.60"x12.60"	3"x13" Floor SBN				
Thickness	9mm	8mm	8mm				
Faces	10	N/A	N/A				
Finish	Matte	Matte	Matte				
Edge	Pressed	Cut	Cut/Rounded				
Grout Joint Recommendation	3/16"	3/16"	3/16"				
Testing	Abrasion Resistance C1027	Breaking Strength C648	Chemical Resistance C650	Water Absorption C373	DCOF ANSI A1371	Scratch Hardness MOHS	Shade Variation Rating
	III	>400 lbf	Resistant	<0.50%	>0.55	7	V2

Product and Installation Details | ANSI A108.02
Section 4.3.8.2 - For running bond/brick jointing patterns utilizing tiles (square or rectangular) where the side being offset is greater than 18" (nominal dimension), the running bond offset will be a maximum of 33% unless otherwise specified by the tile manufacturer. If an offset greater than 33% is specified, specifier and owner must approve mock-up and lippage.



 Sustainability Attributes

- Red List Free
- Health Product Declaration (HPD) provided upon request
- Product Packaging is 100% recyclable
- VOC Free
- Recycled Content 0% Pre-Consumer

*For more information visit www.emser.com. Always consult a professional for proper usage and installation.

Giza™ presents the intriguing appeal of travertine in a durable glazed porcelain tile. Soft tones along with coordinating mosaics create an elegant look.

GIZA™
Glazed Porcelain



LARGE FORMAT  FLOOR / WALL  RESIDENTIAL  COMMERCIAL  INDOOR 



Ash



Smoke



Coal

Mosaics









Ash



Smoke



Coal

Sizes							
	63" x 126" 62.85" x 125.79"	23" x 47" 23.46" x 47.01"	12" x 23" 11.69" x 23.46"	12" x 12" Mesh 11.69" x 11.69"	3" x 12" Floor SBN	6" x 12" Cove Base	1" x 6" Corner
Thickness	7mm	7mm	9mm	9mm	9mm		
Faces	2	10	20	N/A	N/A	N/A	N/A
Finish	Matte	Matte	Matte	Matte	Matte	Matte	Matte
Edge	Rectified	Rectified	Rectified	Cut	Cut/Rounded	Pressed	Pressed
Grout Joint Recommendation	1/8"	1/8"	1/8"	5/64"	5/64"	5/64"	5/64"
Testing	Abrasion Resistance C1027	Breaking Strength C648	Chemical Resistance C650	Water Absorption C373	DCOF ANSI A1371	Scratch Hardness MOHS	Shade Variation Rating
	V	≥300 lbf	Resistant	>0.50%	≥0.50	7	V2

Product and Installation Details | ANSI A108.02
Section 4.3.8.2 - For running bond/brick jointing patterns utilizing tiles (square or rectangular) where the side being offset is greater than 18" (nominal dimension), the running bond offset will be a maximum of 33% unless otherwise specified by the tile manufacturer. If an offset greater than 33% is specified, specifier and owner must approve mock-up and lippage.



 Sustainability Attributes

- Red List Free
- Health Product Declaration (HPD) provided upon request
- Product Packaging is 100% recyclable
- VOC Free

*For more information visit www.emser.com. Always consult a professional for proper usage and installation.



Hangar™ delivers a flexible, modern solution offered in large format and trending tile sizes. The contemporary linear look of Hangar™ adds sophistication to residential and commercial settings.

HANGAR™

Glazed Porcelain



FLOOR / WALL  RESIDENTIAL  INDOOR 



White



Cream



Silver

Mosaics







White



Cream



Silver

Sizes							
	18"x18" 17.60"x17.60"	12"x12" 12.28"x12.28"	12"x12" Mesh 12.28"x12.28"	3"x12" Floor SBN			
Thickness	8.4mm	8mm	7.3mm	8.4mm			
Faces	8	8	N/A	N/A			
Finish	Matte	Matte	Matte	Matte			
Edge	Pressed	Pressed	Cut	Cut/Rounded			
Grout Joint Recommendation	3/16"	3/16"	3/16"	3/16"			
Testing	Abrasion Resistance C1027	Breaking Strength C648	Chemical Resistance C650	Water Absorption C373	DCOF ANSI A1371	Scratch Hardness MOHS	Shade Variation Rating
	Results* III	>250 lbf	Resistant	>7.0%	<0.42	7	V3

 Sustainability Attributes

- Red List Free
- Health Product Declaration (HPD) provided upon request
- Product Packaging is 100% recyclable
- VOC Free

*For more information visit www.emser.com. Always consult a professional for proper usage and installation.

Havana™ is an elegant and understated stone-look showcasing cool and warm neutral colors in a variety of sizes and coordinating mosaics.

HAVANA™

Glazed Ceramic



FLOOR / WALL

RESIDENTIAL

COMMERCIAL

INDOOR

OUTDOOR



White



Silver



Gray



Forest



Navy



Black



Heksa™ | Gray, White, Black, Silver

Sizes



8" x 9"
8.13" x 9.45"

Thickness

8mm

Faces

1

Finish

Matte

Edge

Pressed

Grout Joint Recommendation

1/8"

Testing

Abrasion Resistance
C1027

Breaking Strength
C648

Chemical Resistance
C650

Water Absorption
C373

DCOF ANSI
A1371

Scratch Hardness
MOHS

Shade Variation
Rating

Results*

III
IV - Silver & White

>350 lbf

Resistant

<0.50%

>0.60

7

V1

Sustainability Attributes

- Red List Free
- Health Product Declaration (HPD) provided upon request
- Product Packaging is 100% recyclable
- VOC None
- Recycled Content >30% Pre-Consumer

*For more information visit www.emser.com. Always consult a professional for proper usage and installation.

Heksa™ porcelain tile features the distinct and chic geometric hexagon, as timeless as it is efficient in design. The iconic honeycomb pattern adds edge when creating unique designs, versatile for any room. Heksa colors include six options, as varied as tried-and-true neutrals and a pop of color with green and navy.

HEKSA™

Glazed Porcelain



FLOOR / WALL

RESIDENTIAL

COMMERCIAL

INDOOR

OUTDOOR



Beige



Taupe



Oak



Blue

Sizes Thickness Faces Finish Edge Grout Joint Recommendation							
	8" x 4.67" 7.83" x 4.70"						
	9mm						
	8						
	Matte						
	Rectified						
1/16"							
Testing	Abrasion Resistance C1027	Breaking Strength C648	Chemical Resistance C650	Water Absorption C373	DCOF ANSI A1371	Scratch Hardness MOHS	Shade Variation Rating
Results*	Check Website	Check Website	Resistant	Check Website	>0.65	6	V3

Product and Installation Details | ANSI A108.02
 Section 4.3.8.2 - For running bond/brick jointing patterns utilizing tiles (square or rectangular) where the side being offset is greater than 18" (nominal dimension), the running bond offset will be a maximum of 33% unless otherwise specified by the tile manufacturer. If an offset greater than 33% is specified, specifier and owner must approve mock-up and lippage.



Sustainability Attributes

- Red List Free
- Health Product Declaration (HPD) provided upon request
- Product Packaging is 100% recyclable
- VOC Free
- Recycled Content 0% Pre & Post-Consumer

*For more information visit www.emser.com. Always consult a professional for proper usage and installation.



Fusing old-world glamour with contemporary rustic tones, Hollywood™ adds to the collections of distinct wood-look tile. Beige and Oak colorations recall the beautiful, classic look of aged wood, while Blue and Taupe embrace cool undertones.

HOLLYWOOD™





Glazed Porcelain

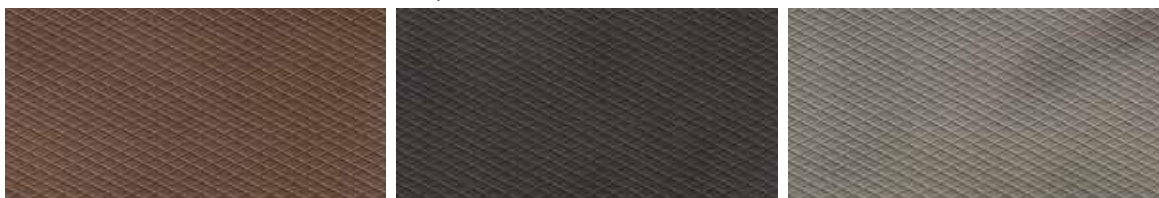
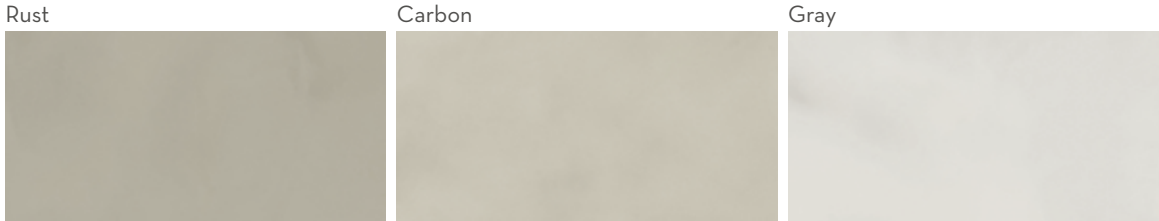
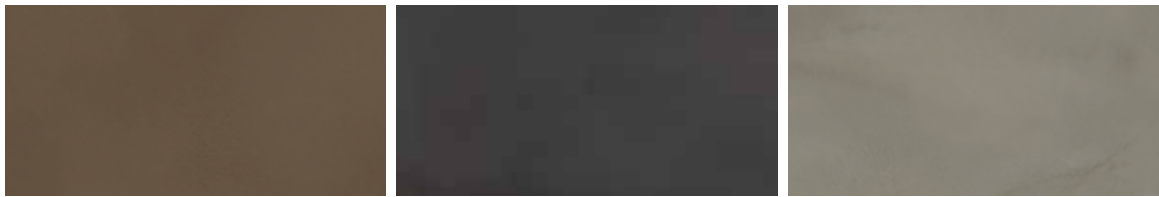

FLOOR / WALL  RESIDENTIAL  COMMERCIAL  INDOOR  OUTDOOR 



Rust Carbon Gray Silver Ivory White

Sizes							
	31" x 31" 31.38" x 31.38"	12" x 23" 11.70" x 23.48"	12" x 12" Mesh	3" x 12" Floor SBN			
Thickness	9mm	9mm	Check Website	Check Website			
Faces	18	72 36 (Ridge Pattern)	Check Website	N/A			
Finish	Matte	Matte	Check Website	Matte			
Edge	Rectified	Rectified	Check Website	Cut/Rounded			
Grout Joint Recommendation	1/8"	1/8"	Check Website	1/8"			
Testing	Abrasion Resistance C1027	Breaking Strength C648	Chemical Resistance C650	Water Absorption C373	DCOF ANSI A1371	Scratch Hardness MOHS	Shade Variation Rating
	III	>350 lbf	Resistant	<0.5%	>0.60 (Flat) <0.42 (Ridge)	7	V2

Product and Installation Details | ANSI A108.02
 Section 4.3.8.2 - For running bond/brick joint patterns utilizing tiles (square or rectangular) where the side being offset is greater than 18" (nominal dimension), the running bond offset will be a maximum of 33% unless otherwise specified by the tile manufacturer. If an offset greater than 33% is specified, specifier and owner must approve mock-up and lippage.



Sustainability Attributes

- Red List Free
- Health Product Declaration (HPD) provided upon request
- Product Packaging is 100% recyclable
- VOC Free
- Recycled Content 9.8-39.6% Pre-Consumer and 0% Post-Consumer

*For more information visit www.emser.com. Always consult a professional for proper usage and installation.



The striking colorways and rich movement of Ironworx™ were inspired by molten metal as it is being forged. This porcelain tile brings to life the style and sophistication of metal in an easy to maintain finish. The matching Ridge pattern adds dimension and subtle texture making Ironworx the perfect centerpiece for floors and walls.

IRONWORX™

Glazed Porcelain



FLOOR / WALL  RESIDENTIAL  COMMERCIAL  INDOOR  OUTDOOR 



Canton





Rue



Maison



Ville

Sizes							
	6" x 35" 5.91" x 35.43"		6" x 24" 5.91" x 23.72"				
Thickness	9mm		9mm				
Faces	9		9				
Finish	Matte		Matte				
Edge	Pressed		Pressed				
Grout Joint Recommendation	3/16"		3/16"				
Testing	Abrasion Resistance C1027	Breaking Strength C648	Chemical Resistance C650	Water Absorption C373	DCOF ANSI A1371	Scratch Hardness MOHS	Shade Variation Rating
	Results*	IV	>400 lbf	Resistant	<0.5%	>0.45	7

Product and Installation Details | ANSI A108.02
 Section 4.3.8.2 - For running bond/brick joining patterns utilizing tiles (square or rectangular) where the side being offset is greater than 18" (nominal dimension), the running bond offset will be a maximum of 33% unless otherwise specified by the tile manufacturer. If an offset greater than 33% is specified, specifier and owner must approve mock-up and lippage.



 Sustainability Attributes

- Red List Free
- Health Product Declaration (HPD) provided upon request
- Product Packaging is 100% recyclable
- VOC Free

*For more information visit www.emser.com. Always consult a professional for proper usage and installation.



Larchmont™ embodies the earthy aesthetic of natural wood in a durable porcelain tile. Warm hues create an inviting atmosphere in a traditional wood plank size.

LARCHMONT™

Glazed Porcelain



FLOOR / WALL  RESIDENTIAL  COMMERCIAL  INDOOR  OUTDOOR 



White



Ivory



Gray



Taupe

Mosaics



White





Ivory



Gray

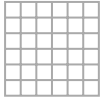

Taupe

Sizes							
	12"x24" 11.81"x23.62"	12"x12" Mesh 11.81"x11.81"	3"x12" Floor SBN				
Thickness	10mm	10mm	10mm				
Faces	24	N/A	N/A				
Finish	Matte	Matte	Matte				
Edge	Pressed	Cut	Cut				
Grout Joint Recommendation	1/8"	5/64"	5/64"				
Testing	Abrasion Resistance C1027	Breaking Strength C648	Chemical Resistance C650	Water Absorption C373	DCOF ANSI A1371	Scratch Hardness MOHS	Shade Variation Rating
	IV	≥500 lbf	Resistant	≤0.50%	>0.50	7	V2

Product and Installation Details | ANSI A108.02
 Section 4.3.8.2 - For running bond/brick joining patterns utilizing tiles (square or rectangular) where the side being offset is greater than 18" (nominal dimension), the running bond offset will be a maximum of 33% unless otherwise specified by the tile manufacturer. If an offset greater than 33% is specified, specifier and owner must approve mock-up and lippage.



 Sustainability Attributes

- Red List Free
- Health Product Declaration (HPD) provided upon request
- Product Packaging is 100% recyclable
- VOC Free

*For more information visit www.emser.com. Always consult a professional for proper usage and installation.



Inspired by the ethereal beauty of the northern lights, Latitude™ is offered in four elegant, neutral colors and coordinating mosaics.

LATITUDE™

Glazed Porcelain



FLOOR / WALL  RESIDENTIAL  COMMERCIAL  INDOOR  OUTDOOR 



White



Sand



Gray



Havana



Brown

Sizes Thickness Faces Finish Edge Grout Joint Recommendation							
	8" x 47" 783" x 4701"						
	9mm						
	20						
	Matte						
	Rectified						
Testing	Abrasion Resistance C1027	Breaking Strength C648	Chemical Resistance C650	Water Absorption C373	DCOF ANSI A1371	Scratch Hardness MOHS	Shade Variation Rating
Results*	III	≥350 lbf	Resistant	≤0.50%	≥0.50	6	V3

Product and Installation Details | ANSI A108.02
 Section 4.3.8.2 - For running bond/brick jointing patterns utilizing tiles (square or rectangular) where the side being offset is greater than 18" (nominal dimension), the running bond offset will be a maximum of 33% unless otherwise specified by the tile manufacturer. If an offset greater than 33% is specified, specifier and owner must approve mock-up and lippage.



 Sustainability Attributes

- Red List Free
- Health Product Declaration (HPD) provided upon request
- Product Packaging is 100% recyclable
- VOC Free
- Recycled Content 40% Pre & Post-Consumer

*For more information visit www.emser.com. Always consult a professional for proper usage and installation.



Inspired by rustic wood, Legacy™ is a glazed porcelain series available in earthy colors and a trending plank format.

LEGACY™

Glazed Porcelain



FLOOR / WALL  RESIDENTIAL  COMMERCIAL  INDOOR  OUTDOOR 



Capri





Elba



Manza



Ulivo

Sizes							
	23" x 47" 23.46" x 47.01"	12" x 23" 11.69" x 23.46"	3" x 12" Floor SBN				
Thickness	9mm	9mm	9mm				
Faces	8	8	N/A				
Finish	Matte	Matte	Matte				
Edge	Rectified	Rectified	Rectified				
Grout Joint Recommendation	1/8"	1/8"	1/8"				
Testing	Abrasion Resistance C1027	Breaking Strength C648	Chemical Resistance C650	Water Absorption C373	DCOF ANSI A1371	Scratch Hardness MOHS	Shade Variation Rating
	Check Website	>250 lbf	Resistant	<0.50%	>0.60	7	V3

Product and Installation Details | ANSI A108.02
Section 4.3.8.2 - For running bond/brick jointing patterns utilizing tiles (square or rectangular) where the side being offset is greater than 18" (nominal dimension), the running bond offset will be a maximum of 33% unless otherwise specified by the tile manufacturer. If an offset greater than 33% is specified, specifier and owner must approve mock-up and lippage.



 Sustainability Attributes

- Red List Free
- Health Product Declaration (HPD) provided upon request
- Product Packaging is 100% recyclable
- VOC Free

*For more information visit www.emser.com. Always consult a professional for proper usage and installation.



Named for the most modern city in the historic Tuscan region of Italy, the Livorno™ collection of porcelain tile evokes the beauty of watercolors with its muted palette and subtle veining. Available in two sizes, it's a perfect complement for a modern design aesthetic with its nod to urban sophistication.

LIVORNO™

Glazed Porcelain





White

Dust

Moon



Gray

Taupe

Mosaics

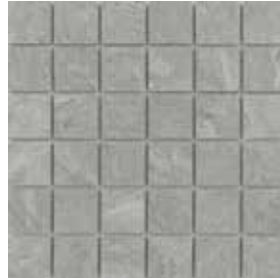

White

Dust

Moon

Taupe

Gray

Sizes							
	24"x47" 23.62"x47.24"	12"x24" 11.81"x23.62"	12"x12" Mesh 11.81"x11.81"	3"x12" Floor SBN			
Thickness	10mm	9mm	9.5mm	10mm			
Faces	5	20-24	N/A	N/A			
Finish	Matte	Matte	Matte	Matte			
Edge	Rectified	Rectified	Cut	Cut/Rounded			
Grout Joint Recommendation	1/8"	1/8"	1/16"	5/64"			
Testing	Abrasion Resistance C1027	Breaking Strength C648	Chemical Resistance C650	Water Absorption C373	DCOF ANSI A1371	Scratch Hardness MOHS	Shade Variation Rating
	Results* IV	≥550 lbf	Resistant	≤0.50%	≥0.60	7	V2

Product and Installation Details | ANSI A108.02
Section 4.3.8.2 - For running bond/brick joining patterns utilizing tiles (square or rectangular) where the side being offset is greater than 18" (nominal dimension), the running bond offset will be a maximum of 33% unless otherwise specified by the tile manufacturer. If an offset greater than 33% is specified, specifier and owner must approve mock-up and lippage.



Sustainability Attributes

- Red List Free
- Health Product Declaration (HPD) provided upon request
- Product Packaging is 100% recyclable
- VOC Free
- Recycled Content >20% Pre-Consumer

*For more information visit www.emser.com. Always consult a professional for proper usage and installation.



Milestone™ embodies the natural elements of slate produced in glazed body match porcelain. Milestone™ is offered in versatile colors and texture variations for a natural aesthetic.

MILESTONE™

Glazed Body Match Porcelain



FLOOR / WALL

RESIDENTIAL

COMMERCIAL

INDOOR

OUTDOOR



Hikari



Daku



Shiro



Gure



Oxford

Sizes Thickness Faces Finish Edge Grout Joint Recommendation							
	8" x 35" 7.87' x 35.43'						
	10mm						
	9						
	Matte						
	Pressed						
Testing	Abrasion Resistance C1027	Breaking Strength C648	Chemical Resistance C650	Water Absorption C373	DCOF ANSI A1371	Scratch Hardness MOHS	Shade Variation Rating
Results*	IV	>500 lbf	Resistant	<0.50%	>0.55	8	V2

Product and Installation Details | ANSI A108.02
 Section 4.3.8.2 - For running bond/brick jointing patterns utilizing tiles (square or rectangular) where the side being offset is greater than 18" (nominal dimension), the running bond offset will be a maximum of 33% unless otherwise specified by the tile manufacturer. If an offset greater than 33% is specified, specifier and owner must approve mock-up and lippage.



Sustainability Attributes

- Red List Free
- Health Product Declaration (HPD) provided upon request
- Product Packaging is 100% recyclable
- VOC Free
- Recycled Content 0% Post-Consumer

*For more information visit www.emser.com. Always consult a professional for proper usage and installation.



Mokuzai II™ captures a timber-inspired design in a porcelain tile. Through high-definition printing, vivid detail is used to achieve appealing wood tones in large format planks.

MOKUZAI II™

Glazed Porcelain



FLOOR / WALL  RESIDENTIAL  COMMERCIAL  INDOOR  OUTDOOR 



Ivory



Gray



Charcoal



River Ivory



River Gray

Mosaics







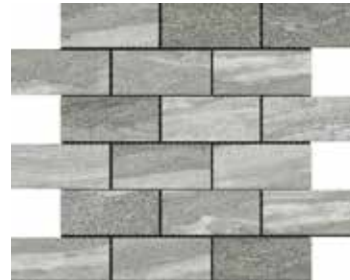

Ivory



Gray



Charcoal

Sizes							
	23" x 47" 23.43" x 46.99"	12" x 23" 11.65" x 23.43"	12" x 12" Mesh	3" x 12" Floor SBN	Cove Base*	Cove Base Corner Out*	
Thickness	10mm	9mm	9mm	9mm	Check Website	Check Website	
Faces	21	84	N/A	N/A	N/A	N/A	
Finish	Matte	Matte	Matte	Matte	Matte	Matte	
Edge	Rectified	Rectified	Cut	Cut/Rounded	Cut/Rounded	Cut/Rounded	
Grout Joint Recommendation	3/16"	3/16"	3/16"	3/16"	3/16"	3/16"	
Testing	Abrasion Resistance C1027	Breaking Strength C648	Chemical Resistance C650	Water Absorption C373	DCOF ANSI A1371	Scratch Hardness MOHS	Shade Variation Rating
	IV	>450 lbf	Resistant	<0.50%	>0.65	9	V3

Product and Installation Details | ANSI A108.02
Section 4.3.8.2 - For running bond/brick jointing patterns utilizing tiles (square or rectangular) where the side being offset is greater than 18" (nominal dimension), the running bond offset will be a maximum of 33% unless otherwise specified by the tile manufacturer. If an offset greater than 33% is specified, specifier and owner must approve mock-up and lippage.



 Sustainability Attributes

- Red List Free
- Health Product Declaration (HPD) provided upon request
- Product Packaging is 100% recyclable
- VOC Free
- Recycled Content 0% Pre & Post-Consumer

*For more information visit www.emser.com. Always consult a professional for proper usage and installation. Please inquire for availability, may require MOQ & leadtime.



Mood™ is reminiscent of the quartzite stone from Vals, in the canton of the Grisons, Switzerland, translated into a durable porcelain tile. Offered in large scale format and trendy hues, Mood is designed for those who want to surround themselves with natural beauty.

MOOD™

Glazed Porcelain



FLOOR / WALL  RESIDENTIAL  COMMERCIAL  INDOOR  OUTDOOR 



Advance





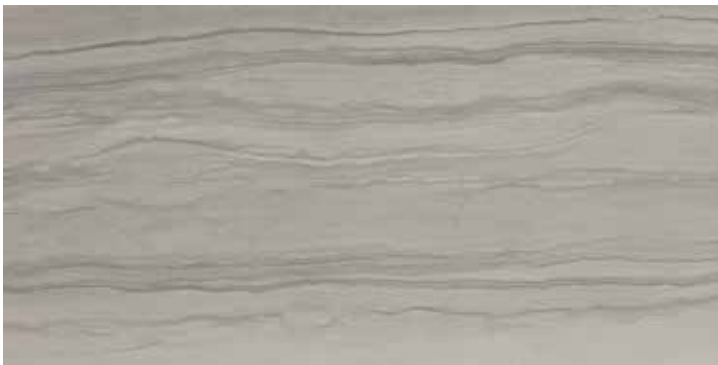

Cue



Drift

Mosaic Blend



Sizes							
	12"x24" 11.81"x23.62"	13"x13" Mesh 13.11"x13.11"	3"x12" Floor SBN	6"x13" Cove Base	1"x6" Cove Base Corner Out		
	Thickness	10mm	10mm	10mm	10mm	9mm	
	Faces	24	N/A	N/A	N/A	N/A	
	Finish	Matte	Matte	Matte	Matte	Matte	
	Edge	Pressed	Cut	Cut/Rounded	Cut/Rounded	Pressed	
Grout Joint Recommendation	1/16"	5/64"	1/8"	1/8"	1/8"		
Testing	Abrasion Resistance C1027	Breaking Strength C648	Chemical Resistance C650	Water Absorption C373	DCOF ANSI A1371	Scratch Hardness MOHS	Shade Variation Rating
Results*	IV	≥600 lbf	Resistant	≤0.50%	≥0.55	7	V2

Product and Installation Details | ANSI A108.02
 Section 4.3.8.2 - For running bond/brick jointing patterns utilizing tiles (square or rectangular) where the side being offset is greater than 18" (nominal dimension), the running bond offset will be a maximum of 33% unless otherwise specified by the tile manufacturer. If an offset greater than 33% is specified, specifier and owner must approve mock-up and lippage.



 Sustainability Attributes

- Red List Free
- Health Product Declaration (HPD) provided upon request
- Product Packaging is 100% recyclable
- VOC Free

*For more information visit www.emser.com. Always consult a professional for proper usage and installation.



Motion™ recreates the look of veincut limestone in glazed porcelain using high-definition printing. Its striking graphic imaging makes any application a fashion statement.

MOTION™
Glazed Body Match Porcelain



LARGE FORMAT  FLOOR / WALL  RESIDENTIAL  COMMERCIAL  INDOOR  OUTDOOR 



White









Silver



Gray



Taupe

Sizes							
	63" x 126" 62.85" x 125.79"	31" x 31" 31.39" x 31.39"	23" x 47" 23.46" x 47.01"	12" x 23" 11.69" x 23.46"	3" x 12" Floor SBN	6" x 13" Cove Base	1" x 6" Cove Base Corner Out
Thickness	6mm	9mm	9mm	9mm	9mm	9mm	9mm
Faces	3	24	10	30	N/A	N/A	N/A
Finish	Matte	Matte	Matte	Matte	Matte	Matte	Matte
Edge	Rectified	Rectified	Rectified	Rectified	Cut	Cut	Cut
Grout Joint Recommendation	1/8"	1/8"	1/8"	1/8"	1/8"	1/8"	1/8"
Testing	Abrasion Resistance C1027	Breaking Strength C648	Chemical Resistance C650	Water Absorption C373	DCOF ANSI A1371	Scratch Hardness MOHS	Shade Variation Rating
	Results* III	>500 lbf	Resistant	<0.50%	≥0.60	7	V2

Product and Installation Details | ANSI A108.02
Section 4.3.8.2 - For running bond/brick jointing patterns utilizing tiles (square or rectangular) where the side being offset is greater than 18" (nominal dimension), the running bond offset will be a maximum of 33% unless otherwise specified by the tile manufacturer. If an offset greater than 33% is specified, specifier and owner must approve mock-up and lippage.



 Sustainability Attributes

- Red List Free
- Health Product Declaration (HPD) provided upon request
- Product Packaging is 100% recyclable
- VOC Free
- Recycled Content >40% Pre-Consumer

*For more information visit www.emser.com. Always consult a professional for proper usage and installation.



Network™ is a recreation of concrete with an industrial, avant-garde look. Offered in large format sizes and stunning hues, Network™ is sure to create a bold statement.

NETWORK™

Glazed Porcelain



FLOOR / WALL  RESIDENTIAL  COMMERCIAL  INDOOR  OUTDOOR 



Bay



Harbor



Ferry



Pier

Mosaics



Bay





Harbor

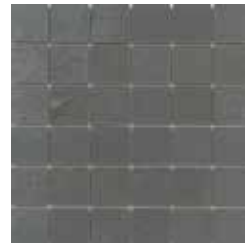

Ferry

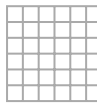

Pier

Sizes							
	12" x 24" 12.20" x 24.02"	12" x 12" Mesh	3" x 12" Floor SBN				
Thickness	9mm	9.5mm	9.5mm				
Faces	16	N/A	N/A				
Finish	Matte, Lappato	Matte	Matte				
Edge	Rectified	Cut	Cut/Rounded				
Grout Joint Recommendation	1/8"	1/8"	1/8"				
Testing	Abrasion Resistance C1027	Breaking Strength C648	Chemical Resistance C650	Water Absorption C373	DCOF ANSI A1371	Scratch Hardness MOHS	Shade Variation Rating
	IV	>400 lbf	Resistant	<0.50%	>0.65	7	V2

Product and Installation Details | ANSI A108.02
 Section 4.3.8.2 - For running bond/brick jointing patterns utilizing tiles (square or rectangular) where the side being offset is greater than 1/8" (nominal dimension), the running bond offset will be a maximum of 33% unless otherwise specified by the tile manufacturer. If an offset greater than 33% is specified, specifier and owner must approve mock-up and lippage.



 Sustainability Attributes

- Red List Free
- Health Product Declaration (HPD) provided upon request
- Product Packaging is 100% recyclable
- VOC Free
- Recycled Content 0% Pre & Post-Consumer

*For more information visit www.emser.com. Always consult a professional for proper usage and installation.

Newport™ artfully blends the look of marble and concrete, creating a notable design aesthetic. Cool undertones highlight the trending industrial look of spaces.

NEWPORT™

Glazed Porcelain

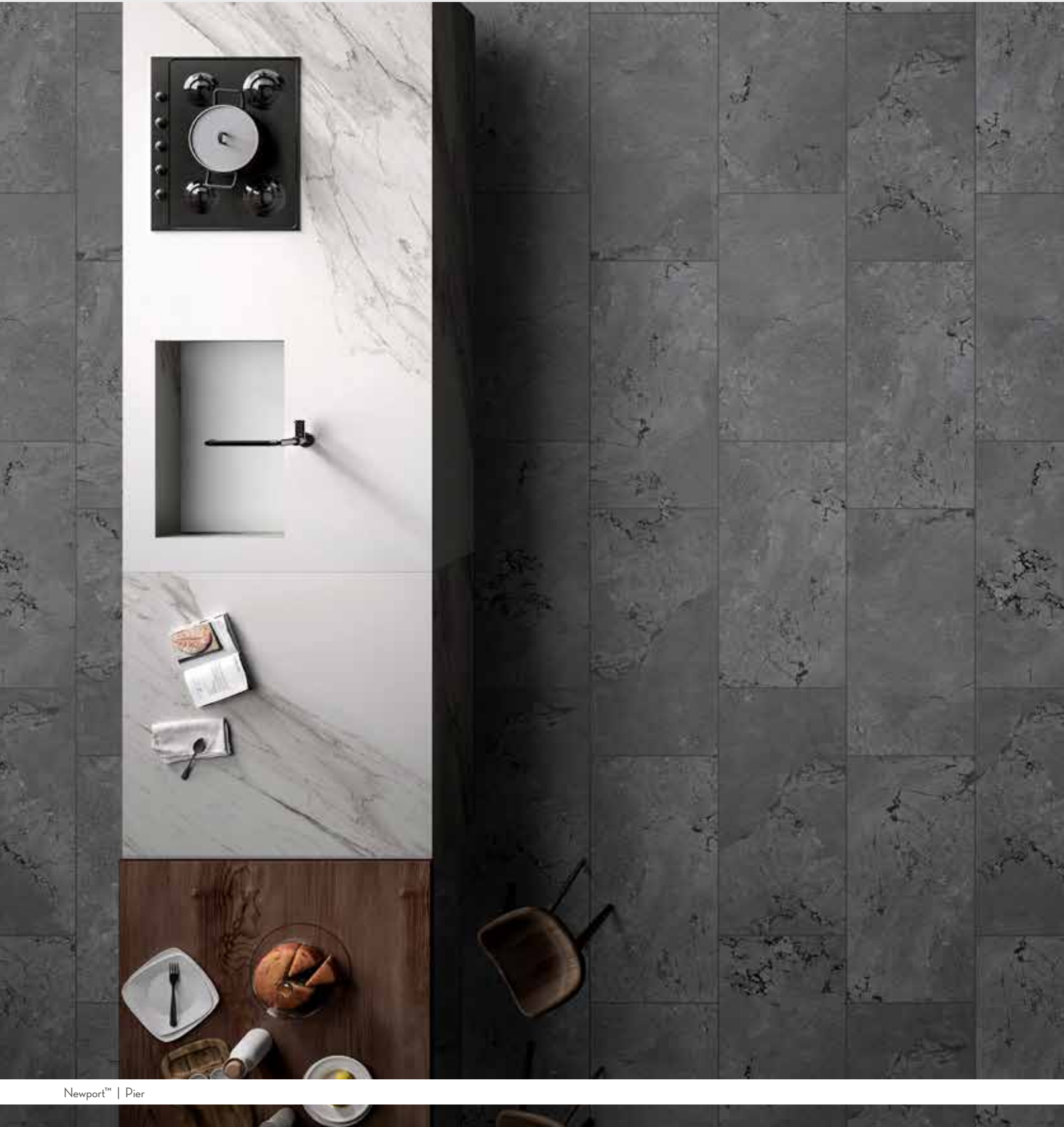

FLOOR / WALL  RESIDENTIAL  COMMERCIAL  INDOOR 



Legend



Novel



Epic



Saga

Sizes  18" x 18" 17.72" x 17.72" Thickness 10.5mm Faces 4 Finish Matte Edge Pressed Grout Joint Recommendation 1/16"								
	Testing	Abrasion Resistance C1027	Breaking Strength C648	Chemical Resistance C650	Water Absorption C373	DCOF ANSI A1371	Scratch Hardness MOHS	Shade Variation Rating
	Results*	IV	>375 lbf	Resistant	3.0 - 7.0%	>0.42	6	V2

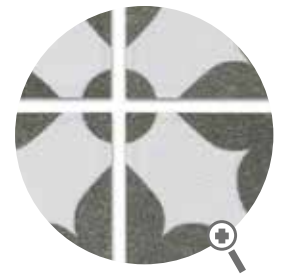

Scored Tile

- Pre-scoring provides a consistent design and easy installation.
- Apply grout directly over the scored tile lines. Fusion Pro grout is recommended.
- Scored lines have a grout width of 1/16".
- Gives the impression of a 9"x9" tile install.
- Great for walls and backsplash applications!

 Sustainability Attributes

- Red List Free
- Health Product Declaration (HPD) provided upon request
- Product Packaging is 100% recyclable
- VOC Free
- Recycled Content 7-10% Pre-Consumer

*For more information visit www.emser.com. Always consult a professional for proper usage and installation.

A traditional look takes on a modern flare with Nostalgia™. The design harkens back to when skilled artisans hand painted tiles. The 18" x 18" pre-scored size combines old world craftsmanship with modern technology providing an easy-to-install designer look.

NOSTALGIA™

Glazed Ceramic



FLOOR / WALL

RESIDENTIAL

COMMERCIAL

INDOOR

OUTDOOR



White



Gray



Blue

Mosaics



White



Gray



Blue

Sizes							
	12" x 24" 11.81" x 23.62"	12" x 12" Mesh 11.81" x 11.81"	3" x 24" Floor SBN				
Thickness	8.5mm	8.5mm	8.5mm				
Faces	18	N/A	N/A				
Finish	Matte	Matte	Matte				
Edge	Pressed	Cut	Cut/Rounded				
Grout Joint Recommendation	1/8"	1/8"	1/8"				
Testing	Abrasion Resistance C1027	Breaking Strength C648	Chemical Resistance C650	Water Absorption C373	DCOF ANSI A1371	Scratch Hardness MOHS	Shade Variation Rating
	III	≥350 lbf	Resistant	≤0.50%	>0.50	5	V3

Product and Installation Details | ANSI A108.02
 Section 4.3.8.2 - For running bond/brick jointing patterns utilizing tiles (square or rectangular) where the side being offset is greater than 18" (nominal dimension), the running bond offset will be a maximum of 33% unless otherwise specified by the tile manufacturer. If an offset greater than 33% is specified, specifier and owner must approve mock-up and lippage.



Sustainability Attributes

- Red List Free
- Health Product Declaration (HPD) provided upon request
- Product Packaging is 100% recyclable
- VOC Free

*For more information visit www.emser.com. Always consult a professional for proper usage and installation.



Offered in soothing, cool tones, Nova™ recreates the classic look of natural stone in a glazed porcelain tile. The soft veining and tonal variation creates depth and textural interest in any application.

NOVA™
Glazed Porcelain



FLOOR / WALL

RESIDENTIAL

COMMERCIAL

INDOOR

OUTDOOR



Dawn



Sunrise



Evening

Sizes Thickness Faces Finish Edge Grout Joint Recommendation							
	8" x 47" <small>7.87" x 47.24"</small>						
	10mm						
	10						
	Matte						
	Rectified						
3/16"							
Testing	Abrasion Resistance C1027	Breaking Strength C648	Chemical Resistance C650	Water Absorption C373	DCOF ANSI A1371	Scratch Hardness MOHS	Shade Variation Rating
Results*	IV	≥750 lbf	Resistant	≤0.50%	≥0.60	8	V4

Product and Installation Details | ANSI A108.02
 Section 4.3.8.2 - For running bond/brick joining patterns utilizing tiles (square or rectangular) where the side being offset is greater than 18" (nominal dimension), the running bond offset will be a maximum of 33% unless otherwise specified by the tile manufacturer. If an offset greater than 33% is specified, specifier and owner must approve mock-up and lippage.



Sustainability Attributes

- Red List Free
- Health Product Declaration (HPD) provided upon request
- Product Packaging is 100% recyclable
- VOC Free

*For more information visit www.emser.com. Always consult a professional for proper usage and installation.



Orchard™ offers the beautiful timeless look of hardwood in stylish colors with the added benefits of porcelain. The graphic details of the warm, earthy colors achieve realistic wood textures in a modish plank size.

ORCHARD™

Glazed Porcelain



FLOOR / WALL  RESIDENTIAL  COMMERCIAL  INDOOR  OUTDOOR 



Bianco





Tortora



Grigio



Antracite

Sizes							
	24" x 47" 23.62" x 47.24"	12" x 24" 11.81" x 23.62"	3" x 12" Floor SBN				
Thickness	10mm	9.5mm	9.5mm				
Faces	8	32	N/A				
Finish	Matte	Matte	Matte				
Edge	Rectified	Rectified	Cut/Rounded				
Grout Joint Recommendation	1/8"	1/8"	1/8"				
Testing	Abrasion Resistance C1027	Breaking Strength C648	Chemical Resistance C650	Water Absorption C373	DCOF ANSI A1371	Scratch Hardness MOHS	Shade Variation Rating
	Results* III - V	>625 lbf	Resistant	<0.50%	>0.42	6	V2

Product and Installation Details | ANSI A108.02
 Section 4.3.8.2 - For running bond/brick joining patterns utilizing tiles (square or rectangular) where the side being offset is greater than 18" (nominal dimension), the running bond offset will be a maximum of 33% unless otherwise specified by the tile manufacturer. If an offset greater than 33% is specified, specifier and owner must approve mock-up and lippage.



 Sustainability Attributes

- Red List Free
- Health Product Declaration (HPD) provided upon request
- Product Packaging is 100% recyclable
- VOC Free
- Recycled Content 20% Pre-Consumer

*For more information visit www.emser.com. Always consult a professional for proper usage and installation.



Outpost™ is a contemporary stone look featuring harmonious variations in hues ideal for any space. The industrial look of stone is combined with warm earthy colors to create the ideal aesthetic.

OUTPOST™

Glazed Body Match Porcelain



FLOOR / WALL  RESIDENTIAL  COMMERCIAL  INDOOR  OUTDOOR  POOL 



Astral

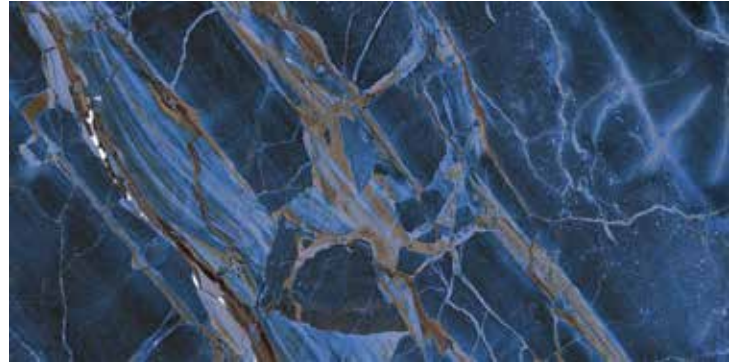

Blue

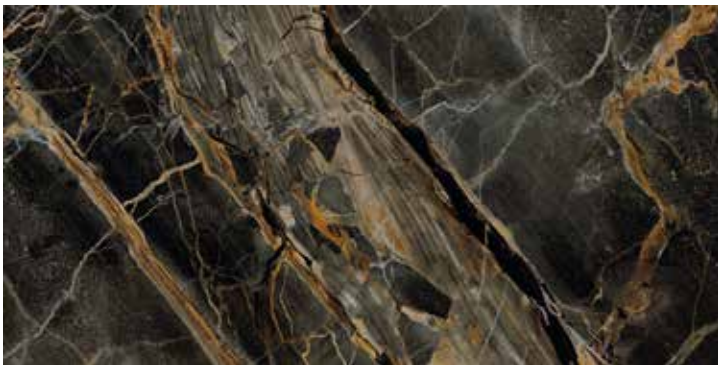



Brown



White

Polished Not Recommended for Use as Commercial Wet Area Flooring or Outdoor Flooring

Sizes							
	24" x 47" 23.46" x 47.05"		12" x 24" 11.69" x 23.46"				
Thickness	7mm		7mm				
Faces	Brown & White: 8 Blue & Astral: 9		Brown & White: 32 Blue & Astral: 36				
Finish	Polished		Matte & Polished				
Edge	Rectified		Rectified				
Grout Joint Recommendation	1/8"		1/8"				
Testing	Abrasion Resistance C1027	Breaking Strength C648	Chemical Resistance C650	Water Absorption C373	DCOF ANSI A1371	Scratch Hardness MOHS	Shade Variation Rating
	Matte: V (Ast./Wht.) II (Blu./Brn.) Polished: II	>350 lbf	Resistant	<0.50%	>0.60 (Matte) <0.42 (Polished)	6 (Matte) 4 (Polished)	V2

Product and Installation Details | ANSI A108.02
Section 4.3.8.2 - For running bond/brick jointing patterns utilizing tiles (square or rectangular) where the side being offset is greater than 18" (nominal dimension), the running bond offset will be a maximum of 33% unless otherwise specified by the tile manufacturer. If an offset greater than 33% is specified, specifier and owner must approve mock-up and lippage.



Sustainability Attributes

- Red List Free
- Health Product Declaration (HPD) provided upon request
- Product Packaging is 100% recyclable
- VOC Free

*For more information visit www.emser.com. Always consult a professional for proper usage and installation.



Inspired by the world's finest marbles, Parkview™ offers traditional marble looks with classic whites and the deepest blacks as well as unconventional marbles with its deep, rich cobalt blue. Each unique tile is enhanced by contrasting veining and striking golds. The thin 7mm thickness makes installation a breeze.

PARKVIEW™

Glazed Porcelain



FLOOR / WALL  RESIDENTIAL  COMMERCIAL  INDOOR  OUTDOOR 



Annata



Dolce



Secco



Talento

Mosaics



Annata







Dolce



Secco



Talento

Sizes							
	24" x 24" 23,62" x 23,62"	12" x 24" 11,81" x 23,62"	12" x 12" Mesh 11,81" x 11,81"	3" x 12" Floor SBN			
Thickness	10,5mm	10mm	8,5mm	10mm			
Faces	8	11	N/A	20			
Finish	Matte	Matte	Matte	Matte			
Edge	Pressed	Pressed	Cut	Cut/Rounded			
Grout Joint Recommendation	3/16"	3/16"	3/16"	3/16"			
Testing	Abrasion Resistance C1027	Breaking Strength C648	Chemical Resistance C650	Water Absorption C373	DCOF ANSI A1371	Scratch Hardness MOHS	Shade Variation Rating
	IV	>400 lbf	Resistant	<0.50%	>0.42	6	V2

Product and Installation Details | ANSI A108.02
Section 4.3.8.2 - For running bond/brick jointing patterns utilizing tiles (square or rectangular) where the side being offset is greater than 18" (nominal dimension), the running bond offset will be a maximum of 33% unless otherwise specified by the tile manufacturer. If an offset greater than 33% is specified, specifier and owner must approve mock-up and lippage.



 Sustainability Attributes

- Red List Free
- Health Product Declaration (HPD) provided upon request
- Product Packaging is 100% recyclable
- VOC Free

*For more information visit www.emser.com. Always consult a professional for proper usage and installation.

Looking for a design moment? Look no further than Pienza™. Named after a glorious Tuscan town, the collection delivers a sophisticated look for the home. Four neutral colorways offer depth, texture and unique looks.

PIENZA™

Glazed Porcelain



FLOOR / WALL  RESIDENTIAL  COMMERCIAL  INDOOR  OUTDOOR 





Smoke



Oak



Gray

Sizes							
	6" x 36" 5.91" x 35.43"		6" x 24" 5.91" x 23.62"				
Thickness	10mm		10.5mm				
Faces	20		20				
Finish	Matte		Matte				
Edge	Pressed		Pressed				
Grout Joint Recommendation	3/16"		3/16"				
Testing	Abrasion Resistance C1027	Breaking Strength C648	Chemical Resistance C650	Water Absorption C373	DCOF ANSI A1371	Scratch Hardness MOHS	Shade Variation Rating
	Results*	IV	≥300 lbf	Resistant	≤0.50%	≥0.60	7

Product and Installation Details | ANSI A108.02
 Section 4.3.8.2 - For running bond/brick jointing patterns utilizing tiles (square or rectangular) where the side being offset is greater than 18" (nominal dimension), the running bond offset will be a maximum of 33% unless otherwise specified by the tile manufacturer. If an offset greater than 33% is specified, specifier and owner must approve mock-up and lippage.



 Sustainability Attributes

- Red List Free
- Health Product Declaration (HPD) provided upon request
- Product Packaging is 100% recyclable
- VOC Free

*For more information visit www.emser.com. Always consult a professional for proper usage and installation.

Pocono™ mimics the unique gradations and variances found in natural wood. This series is offered in sizes inspired by natural wood flooring and durable glazed porcelain.

POCONO™
Glazed Porcelain



FLOOR / WALL

RESIDENTIAL

COMMERCIAL

INDOOR

OUTDOOR



Moon



Midnight



Caramel



Coffee

Sizes							
	12" x 47" 11.61" x 47.24"	8" x 47" 7.68" x 47.24"	6" x 47" 5.71" x 47.24"				
Thickness	11.3mm	11.3mm	11.3mm				
Faces	20	30	40				
Finish	Matte	Matte	Matte				
Edge	Rectified	Rectified	Rectified				
Grout Joint Recommendation	3/16"	3/16"	3/16"				
Testing	Abrasion Resistance C1027	Breaking Strength C648	Chemical Resistance C650	Water Absorption C373	DCOF ANSI A1371	Scratch Hardness MOHS	Shade Variation Rating
	III	≥250 lbf	Resistant	≤0.50%	>0.60	6	V4

Product and Installation Details | ANSI A108.02
 Section 4.3.8.2 - For running bond/brick jointing patterns utilizing tiles (square or rectangular) where the side being offset is greater than 18" (nominal dimension), the running bond offset will be a maximum of 33% unless otherwise specified by the tile manufacturer. If an offset greater than 33% is specified, specifier and owner must approve mock-up and lippage.



Sustainability Attributes

- Red List Free
- Health Product Declaration (HPD) provided upon request
- Product Packaging is 100% recyclable
- VOC Free

*For more information visit www.emser.com. Always consult a professional for proper usage and installation.

Porch™ features subtle wood grain movement that flows across tile panels. Caramel and coffee inspired tones invite color variation on interior and exterior floors. An understated matte finish completes the glazed porcelain tile for enhanced visual depth.

PORCH™

Glazed Porcelain



FLOOR / WALL  RESIDENTIAL  COMMERCIAL  INDOOR  OUTDOOR 



White



Ivory



Fawn



Charcoal

Mosaics

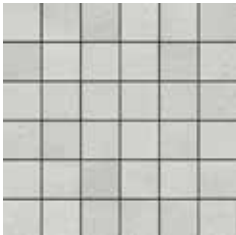

White







Ivory



Fawn

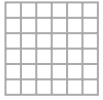

Charcoal

Sizes							
	32" x 32" 31.50" x 31.50"	24" x 24" 23.62" x 23.62"	12" x 24" 11.81" x 23.62"	12" x 12" Mesh	3" x 12" Floor SBN		
Thickness	10mm	9mm	9mm	9mm	9mm		
Faces	8	8	10	N/A	N/A		
Finish	Matte & Polished	Matte & Polished	Matte & Polished	Matte	Matte & Polished		
Edge	Rectified	Rectified	Rectified	Cut	Cut/Rounded		
Grout Joint Recommendation	3/16"	3/16"	3/16"	3/16"	3/16"		
Testing	Abrasion Resistance C1027	Breaking Strength C648	Chemical Resistance C650	Water Absorption C373	DCOF ANSI A1371	Scratch Hardness MOHS	Shade Variation Rating
	III	>550 lbf	Resistant	<0.50%	>0.50 (Matte) <0.42 (Polished)	7 (Matte) 6 (Polished)	V3

Polished not recommended for use as commercial or outdoor flooring.

Product and Installation Details | ANSI A108.02 Section 4.3.8.2 - For running bond/brick jointing patterns utilizing tiles (square or rectangular) where the side being offset is greater than 18" (nominal dimension), the running bond offset will be a maximum of 33% unless otherwise specified by the tile manufacturer. If an offset greater than 33% is specified, specifier and owner must approve mock-up and lippage.



Sustainability Attributes

- Red List Free
- Health Product Declaration (HPD) provided upon request
- Product Packaging is 100% recyclable
- VOC Free

*For more information visit www.emser.com. Always consult a professional for proper usage and installation.

Porto II™ is inspired by the simplistic look of concrete and stone in large format sizes and a range of colors. Available in matte or polished, Porto II is ideal for both residential and commercial spaces.

PORTO II™

Glazed Porcelain



FLOOR / WALL  RESIDENTIAL  COMMERCIAL  INDOOR  OUTDOOR 



Ivory



Dove



Fawn



Gray

Mosaics



Ivory

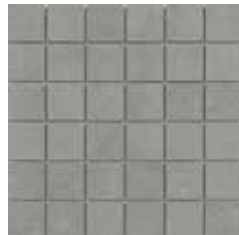





Dove



Fawn



Gray

Sizes							
	18"x18" 17.72"x17.72"	13"x13" 12.99"x12.99"	12"x24" 11.75"x23.62"	13"x13" Mesh 12.60"x12.60"	3"x13" Floor SBN		
Thickness	8.8mm	7.8mm	9.8mm	8.3mm	8.3mm		
Faces	7	13	9	N/A	N/A		
Finish	Matte	Matte	Matte	Matte	Matte		
Edge	Pressed	Pressed	Pressed	Cut	Cut/Rounded		
Grout Joint Recommendation	1/8"	1/8"	1/8"	5/32"	3/16"		
Testing	Abrasion Resistance C1027	Breaking Strength C648	Chemical Resistance C650	Water Absorption C373	DCOF ANSI A1371	Scratch Hardness MOHS	Shade Variation Rating
	IV	≥350 lbf	Resistant	≤0.50%	≥0.70	7	V3

Product and Installation Details | ANSI A108.02
 Section 4.3.8.2 - For running bond/brick jointing patterns utilizing tiles (square or rectangular) where the side being offset is greater than 18" (nominal dimension), the running bond offset will be a maximum of 33% unless otherwise specified by the tile manufacturer. If an offset greater than 33% is specified, specifier and owner must approve mock-up and lippage.



 Sustainability Attributes

- Red List Free
- Health Product Declaration (HPD) provided upon request
- Product Packaging is 100% recyclable
- VOC Free

*For more information visit www.emser.com. Always consult a professional for proper usage and installation.

Potenza™ embodies the earthy aesthetic of travertine in a durable porcelain tile. The linear brushed look creates a harmonious flow in a variety of colors.

POTENZA™
Glazed Porcelain



FLOOR / WALL  RESIDENTIAL  COMMERCIAL  INDOOR  OUTDOOR 



Assembly



District



Domain



Nation

Mosaics

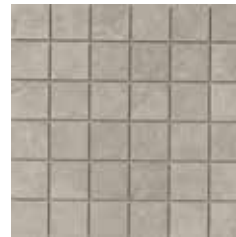
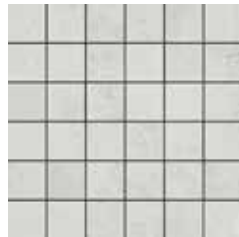
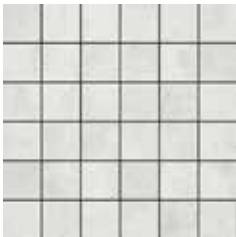





Assembly

District

Domain

Nation

Sizes							
	18"x18" 17.72"x17.72"	13"x13" 12.99"x12.99"	12"x24" 11.81"x23.62"	13"x13" Mesh	3"x13" Floor SBN		
Thickness	8.8mm	7.2mm	9.8mm	8mm	8mm		
Faces	11	11	10	N/A	N/A		
Finish	Matte	Matte	Matte	Matte	Matte		
Edge	Pressed	Pressed	Pressed	Cut	Cut/Rounded		
Grout Joint Recommendation	3/16"	3/16"	3/16"	3/16"	3/16"		
Testing	Abrasion Resistance C1027	Breaking Strength C648	Chemical Resistance C650	Water Absorption C373	DCOF ANSI A1371	Scratch Hardness MOHS	Shade Variation Rating
	IV	>350 lbf	Resistant	<0.50%	>0.50	7	V3

Product and Installation Details | ANSI A108.02
Section 4.3.8.2 - For running bond/brick joint patterns utilizing tiles (square or rectangular) where the side being offset is greater than 18" (nominal dimension), the running bond offset will be a maximum of 33% unless otherwise specified by the tile manufacturer. If an offset greater than 33% is specified, specifier and owner must approve mock-up and lippage.



 Sustainability Attributes

- Red List Free
- Health Product Declaration (HPD) provided upon request
- Product Packaging is 100% recyclable
- VOC Free

*For more information visit www.emser.com. Always consult a professional for proper usage and installation.



Realm II™ mirrors traditional honed marble with subtle veining and refined movement. Sophisticated colors with crackled and distressed details lend a natural aesthetic. A matte finish and various tile sizes make Realm II™ ideal for numerous interiors.

REALM II™

Glazed Porcelain



FLOOR / WALL  RESIDENTIAL  COMMERCIAL  INDOOR 



Court



Lane



Patio



Wynd

Sizes  18" x 18" 17.72" x 17.72"							
	Thickness	10.5mm					
	Faces	1					
	Finish	Matte					
	Edge	Pressed					
Grout Joint Recommendation	1/16"						
Testing	Abrasion Resistance C1027	Breaking Strength C648	Chemical Resistance C650	Water Absorption C373	DCOF ANSI A1371	Scratch Hardness MOHS	Shade Variation Rating
Results*	IV	>375 lbf	Resistant	3.0% - 7.0%	>0.42	6	V1



Scored Tile

- Pre-scoring provides a consistent design and easy installation.
- Apply grout directly over the scored tile lines. Fusion Pro grout is recommended.
- Scored lines have a grout width of 1/16".
- Gives the impression of a 9"x9" tile install.
- Great for walls and backsplash applications!

 Sustainability Attributes

- Red List Free
- Health Product Declaration (HPD) provided upon request
- Product Packaging is 100% recyclable
- VOC Free
- Recycled Content 7-10% Pre-Consumer

*For more information visit www.emser.com. Always consult a professional for proper usage and installation.

Celebrating classic patterns of the past with a modern twist - that's the beauty of Reminisce™. The collection offers an eclectic group of designs, providing a wide array of solutions for any space. A kaleidoscope of shapes and color delivers a statement that stands the test of time.

REMINISCE™

Glazed Ceramic



FLOOR / WALL  RESIDENTIAL  COMMERCIAL  INDOOR  OUTDOOR 



Alto



Manu



Pampa



Tumbes

Mosaics



Alto







Manu



Pampa

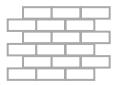

Tumbes

Sizes							
	13" x 13" 12.99" x 12.99"	12" x 24" 11.81" x 23.62"	13" x 13" Mesh	3" x 13" Floor SBN			
Thickness	7.8mm	9mm	9mm	7.5mm			
Faces	47	37	N/A	N/A			
Finish	Matte	Matte	Matte	Matte			
Edge	Pressed	Pressed	Cut	Cut/Rounded			
Grout Joint Recommendation	3/16"	3/16"	3/16"	3/16"			
Testing	Abrasion Resistance C1027	Breaking Strength C648	Chemical Resistance C650	Water Absorption C373	DCOF ANSI A1371	Scratch Hardness MOHS	Shade Variation Rating
	IV	≥400 lbf	Resistant	≤0.50%	≥0.56	7	V3

Product and Installation Details | ANSI A108.02
Section 4.3.8.2 - For running bond/brick jointing patterns utilizing tiles (square or rectangular) where the side being offset is greater than 18" (nominal dimension), the running bond offset will be a maximum of 33% unless otherwise specified by the tile manufacturer. If an offset greater than 33% is specified, specifier and owner must approve mock-up and lippage.



 Sustainability Attributes

- Red List Free
- Health Product Declaration (HPD) provided upon request
- Product Packaging is 100% recyclable
- VOC Free

*For more information visit www.emser.com. Always consult a professional for proper usage and installation.

Showcasing the complex veining of rare marble, Reserva™ brings to life the timeless look with multiple sizes and stunning colors.

RESERVA™

Glazed Porcelain



FLOOR / WALL  RESIDENTIAL  COMMERCIAL  INDOOR  OUTDOOR  POOL 



White



Diagonal



Spade



Black



Floral



Argyle



Pattern Suggestions

Sizes Thickness Faces Finish Edge Grout Joint Recommendation							
	13"x13" 12.99"x12.99"						
	10mm						
	1						
	Matte						
	Pressed						
Testing	Abrasion Resistance C1027	Breaking Strength C648	Chemical Resistance C650	Water Absorption C373	DCOF ANSI A1371	Scratch Hardness MOHS	Shade Variation Rating
Results*	III	>400 lbf	Resistant	<0.50%	>0.60	6	V2



 Sustainability Attributes

- Red List Free
- Health Product Declaration (HPD) provided upon request
- Product Packaging is 100% recyclable
- VOC Free

*For more information visit www.emser.com. Always consult a professional for proper usage and installation.

With Rhapsody®, the design possibilities are endless. Create a classic black and white checkered pattern or utilize any combination of the solids and patterns to create your own masterpiece. The alluring distressed finish makes a statement in any room.

RHAPSODY®

Glazed Porcelain



FLOOR / WALL  RESIDENTIAL  COMMERCIAL  INDOOR  OUTDOOR 



White Hex Pattern



Black Hex Pattern

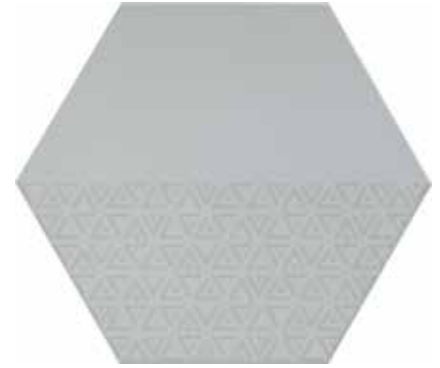

Silver Hex Pattern



White Hex





Black Hex



Silver Hex

Pattern tiles not recommended for floor applications.

Sizes Thickness Faces Finish Edge Grout Joint Recommendation	 11" x 13" 11.22" x 12.99"						
	9mm						
	1						
	Matte						
	Pressed						
	1/8"						
Testing	Abrasion Resistance <small>C1027</small>	Breaking Strength <small>C648</small>	Chemical Resistance <small>C650</small>	Water Absorption <small>C373</small>	DCOF ANSI <small>A1371</small>	Scratch Hardness MOHS	Shade Variation Rating
Results*	IV	>275 lbf	Resistant	<0.50%	>0.42 (Solid) <0.42 (Pattern)	6	V1

 Sustainability Attributes

- Red List Free
- Health Product Declaration (HPD) provided upon request
- Product Packaging is 100% recyclable
- VOC Free

*For more information visit www.emser.com. Always consult a professional for proper usage and installation.

Rhythm™ creates a stunning look in your space with its geometric shape and unique design detail. Available in Black, White, and Silver and in solid or pattern designs, Rhythm brings new life to the traditional hex. Combine pattern tiles with solid and create a truly memorable, and design inspired look.

RHYTHM™

Glazed Porcelain



FLOOR / WALL  RESIDENTIAL  COMMERCIAL  INDOOR 



Taupe



Brown

Sizes Thickness Faces Finish Edge Grout Joint Recommendation							
	9" x 36" 8,96" x 36,02"						
	9.2mm						
	6						
	Matte						
	Pressed						
Testing	Abrasion Resistance <small>C1027</small>	Breaking Strength <small>C648</small>	Chemical Resistance <small>C650</small>	Water Absorption <small>C373</small>	DCOF ANSI <small>A1371</small>	Scratch Hardness MOHS	Shade Variation Rating
Results*	IV	>250 lbf	Resistant	<0.50%	>0.42	Check Website	V3

Product and Installation Details | ANSI A108.02
 Section 4.3.8.2 - For running bond/brick jointing patterns utilizing tiles (square or rectangular) where the side being offset is greater than 18" (nominal dimension), the running bond offset will be a maximum of 33% unless otherwise specified by the tile manufacturer. If an offset greater than 33% is specified, specifier and owner must approve mock-up and lippage.



 Sustainability Attributes

- Red List Free
- Health Product Declaration (HPD) provided upon request
- Product Packaging is 100% recyclable
- VOC Free
- Recycled Content 40% Pre-Consumer

*For more information visit www.emser.com. Always consult a professional for proper usage and installation.



Sanctuary II™ reflects the simplistic beauty of natural wood grains in a durable glazed porcelain tile. Warm neutrals with rustic undertones bring a quiet elegance for an inviting retreat. Subtle visual and tactile textures elongate surfaces for a versatile, sophisticated linear design.

SANCTUARY II™

Glazed Porcelain



FLOOR / WALL  RESIDENTIAL  COMMERCIAL  INDOOR  OUTDOOR 



Gobi



Kalahari



Mojave



Sahara

Mosaics



Gobi

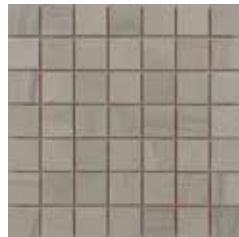

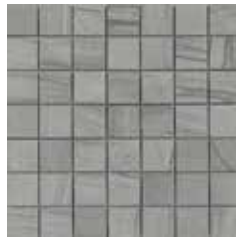

Kalahari



Mojave

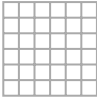

Sahara

Sizes   	12" x 24" 11.81" x 23.62"	13" x 13" Mesh 13.07" x 13.07"	3" x 12" Floor SBN				
	Thickness	9.8mm	9.8mm	9.5mm			
	Faces	16	N/A	N/A			
	Finish	Matte	Matte	Matte			
	Edge	Pressed	Cut	Cut Rounded			
Grout Joint Recommendation	3/16"	3/16"	3/16"				
Testing	Abrasion Resistance C1027	Breaking Strength C648	Chemical Resistance C650	Water Absorption C373	DCOF ANSI A1371	Scratch Hardness MOHS	Shade Variation Rating
Results*	III	≥300 lbf	Resistant	≤0.50%	≥0.50	7	V2

Product and Installation Details | ANSI A108.02
 Section 4.3.8.2 - For running bond/brick jointing patterns utilizing tiles (square or rectangular) where the side being offset is greater than 18" (nominal dimension), the running bond offset will be a maximum of 33% unless otherwise specified by the tile manufacturer. If an offset greater than 33% is specified, specifier and owner must approve mock-up and lippage.



 Sustainability Attributes

- Red List Free
- Health Product Declaration (HPD) provided upon request
- Product Packaging is 100% recyclable
- VOC Free

*For more information visit www.emser.com. Always consult a professional for proper usage and installation.



Sandstorm™ reflects the captivating layers of sandstone in a glazed porcelain tile. High-definition printing enables natural-looking color variation, veining and fissure lines for which natural stone is known.

SANDSTORM™

Glazed Porcelain



FLOOR / WALL  RESIDENTIAL  COMMERCIAL  INDOOR  OUTDOOR  POOL 

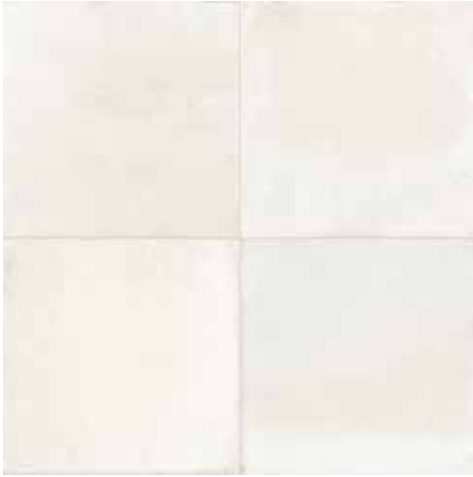

Bianco

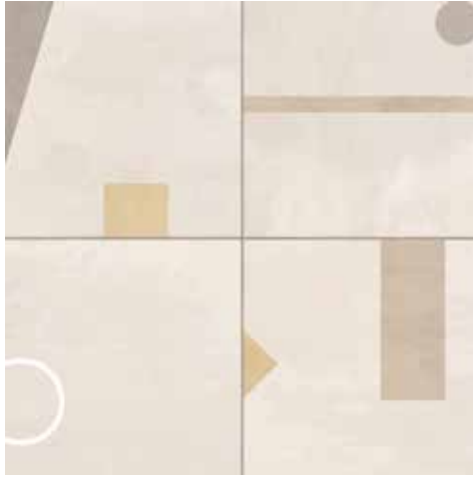

Bianco Fashion



Natural



Shard



Flair

Sizes Thickness Faces Finish Edge Grout Joint Recommendation	 18"x18" 17.72"x17.72"						
	10.5mm						
	10						
	Matte						
	Pressed						
	1/16"						
Testing	Abrasion Resistance C1027	Breaking Strength C648	Chemical Resistance C650	Water Absorption C373	DCOF ANSI A1371	Scratch Hardness MOHS	Shade Variation Rating
Results*	III	>350 lbf	Resistant	<0.5%	>0.60	5	V2

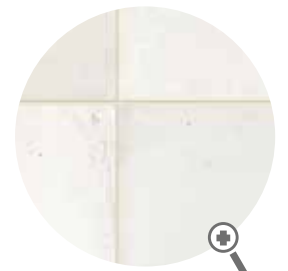

Scored Tile

- Pre-scoring provides a consistent design and easy installation.
- Apply grout directly over the scored tile lines. Fusion Pro grout is recommended.
- Scored lines have a grout width of 1/16".
- Gives the impression of a 9"x9" tile install.
- Great for walls and backsplash applications!

 Sustainability Attributes

- Red List Free
- Health Product Declaration (HPD) provided upon request
- Product Packaging is 100% recyclable
- VOC Free
- Recycled Content 7-10% Pre-Consumer

*For more information visit www.emser.com. Always consult a professional for proper usage and installation.

Design that comes alive - meet Señora™. The elegant Spanish styling marries perfectly with modern design providing a sophisticated look. The subtle colorways pay homage to Spanish style architecture and brings a touch of warmth to any space.

SEÑORA™

Glazed Ceramic



FLOOR / WALL



RESIDENTIAL



INDOOR



Luna



Mila



Zara

Sizes							
	31" x 31" 31.30" x 31.30"	24" x 47" 23.50" x 47.09"	12" x 24" Matte 11.81" x 23.62"	12" x 24" Polished 11.69" x 23.50"			
Thickness	10mm	9mm	8mm	8mm			
Faces	4	4	12	12			
Finish	Matte & Polished	Matte & Polished	Matte	Polished			
Edge	Rectified	Rectified	Pressed	Rectified			
Grout Joint Recommendation	1/8"	1/8"	3/16"	1/8"			
Testing	Abrasion Resistance C1027	Breaking Strength C648	Chemical Resistance C650	Water Absorption C373	DCOF ANSI A1371	Scratch Hardness MOHS	Shade Variation Rating
	Check Website	Check Website	Check Website	Check Website	Check Website	Check Website	V2

Product and Installation Details | ANSI A108.02
Section 4.3.8.2 - For running bond/brick jointing patterns utilizing tiles (square or rectangular) where the side being offset is greater than 18" (nominal dimension), the running bond offset will be a maximum of 33% unless otherwise specified by the tile manufacturer. If an offset greater than 33% is specified, specifier and owner must approve mock-up and lippage.



Sustainability Attributes

- Red List Free
- Health Product Declaration (HPD) provided upon request
- Product Packaging is 100% recyclable
- VOC Free

*For more information visit www.emser.com. Always consult a professional for proper usage and installation.

Want to give your next design project a look of modern elegance? Serendra™ porcelain marble look tile provides a cool, rich and distinguished look that never goes out of style and is easy to maintain. The variations in each tile contribute to its distinctive appeal. Serendra comes in three colors and three sizes.

SERENDRA™

Glazed Porcelain



FLOOR / WALL  RESIDENTIAL  COMMERCIAL  INDOOR  OUTDOOR 



Contour



Figure



Profile



Shadow

Mosaics

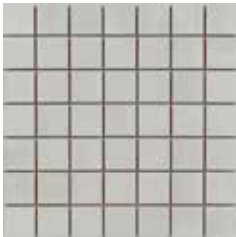

Contour

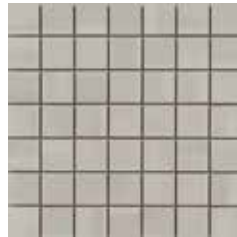



Figure



Profile

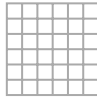

Shadow

Sizes							
	12"x24" 11.81"x23.62"	13"x13" Mesh	3"x12" Floor SBN				
Thickness	9.8mm	9.8mm	9.7mm				
Faces	6	N/A	N/A				
Finish	Matte	Matte	Matte				
Edge	Pressed	Cut	Cut/Rounded				
Grout Joint Recommendation	1/8"	3/16"	3/16"				
Testing	Abrasion Resistance C1027	Breaking Strength C648	Chemical Resistance C650	Water Absorption C373	DCOF ANSI A1371	Scratch Hardness MOHS	Shade Variation Rating
	III	≥700 lbf	Not Resistant	≤0.50%	≥0.55	6	V3

Product and Installation Details | ANSI A108.02
Section 4.3.8.2 - For running bond/brick jointing patterns utilizing tiles (square or rectangular) where the side being offset is greater than 18" (nominal dimension), the running bond offset will be a maximum of 33% unless otherwise specified by the tile manufacturer. If an offset greater than 33% is specified, specifier and owner must approve mock-up and lippage.



 Sustainability Attributes

- Red List Free
- Health Product Declaration (HPD) provided upon request
- Product Packaging is 100% recyclable
- VOC Free

*For more information visit www.emser.com. Always consult a professional for proper usage and installation.

Inspired by the artistic blend of watercolors, Silhouette™ strides in with soft tones and linear flow creating an inviting environment.

SILHOUETTE™

Glazed Porcelain



FLOOR / WALL  RESIDENTIAL  COMMERCIAL  INDOOR  OUTDOOR 



Asphalt



Henna



Dove



Ivory









Gray



Silver



White

Sizes							
	24"x24" 23.62"x23.62"	24"x47" 23.62"x47.24"	12"x24" 11.81"x23.62"	6"x12" 5.83"x11.81"	9"x10"	13"x13" Mesh 12.60"x12.60"	3"x12" Floor SBN
Thickness	9.3mm	10.2mm	8.4mm	8.4mm	8mm	9mm	8.4mm
Faces	12	6	12	12	Check Website	N/A	N/A
Finish	Matte & Polished	Matte & Polished	Matte & Polished	Polished	Matte	Matte	Matte & Polished
Edge	Rectified	Rectified	Rectified	Rectified	Check Website	Cut	Cut/Round
Grout Joint Recommendation	1/8"	1/8"	1/8"	3/64"	Check Website	1/8"	1/8"
Testing	Abrasion Resistance C1027	Breaking Strength C648	Chemical Resistance C650	Water Absorption C373	DCOF ANSI A1371	Scratch Hardness MOHS	Shade Variation Rating
	IV	>345 lbf	Resistant	<0.50%	>0.55 (Matte) <0.42 (Polished)	7 (Matte) 3 (Polished)	V2 V3 (6"x12")

Product and Installation Details | ANSI A108.02
Section 4.3.8.2 - For running bond/brick jointing patterns utilizing tiles (square or rectangular) where the side being offset is greater than 18" (nominal dimension), the running bond offset will be a maximum of 33% unless otherwise specified by the tile manufacturer. If an offset greater than 33% is specified, specifier and owner must approve mock-up and lippage.



 Sustainability Attributes

- Red List Free
- Health Product Declaration (HPD) provided upon request
- Product Packaging is 100% recyclable
- VOC Free

*For more information visit www.emser.com. Always consult a professional for proper usage and installation.

Sterlina™ beautifully unifies the look of timeless marble with the urban touch of concrete. Available in matte and polished finish and seven colorways to achieve any desired look.

STERLINA™

Glazed Porcelain



FLOOR / WALL

RESIDENTIAL

COMMERCIAL

INDOOR

OUTDOOR



Pure White

Mosaics



	32" x 32" 31.50" x 31.50"	24" x 47" 23.62" x 47.24"	24" x 24" 23.62" x 23.62"	12" x 24" 11.81" x 23.62"	12" x 12" Mesh	12" x 12" Mesh	3" x 12" Floor SBN
Sizes							
Thickness	9.5mm	9.5mm	9.5mm	9.5mm	9.4mm	9.4mm	9.5mm
Faces	1	1	1	1	N/A	N/A	1
Finish	Polished	Polished	Matte & Polished	Matte & Polished	Matte	Polished	Matte & Polished
Edge	Rectified	Rectified	Rectified	Rectified	Cut	Cut	Cut/Rounded
Grout Joint Recommendation	3/16"	3/16"	3/16"	3/16"	3/16"	3/16"	3/16"
Testing	Abrasion Resistance C1027	Breaking Strength C648	Chemical Resistance C650	Water Absorption C373	DCOF ANSI A1371	Scratch Hardness MOHS	Shade Variation Rating
Results*	IV (Matte) III (Polished)	>400 lbf	Resistant	<0.50%	>0.55 (Matte) <0.42 (Polished)	7 (Matte) 5 (Polished)	V1

Product and Installation Details | ANSI A108.02
Section 4.3.8.2 - For running bond/brick jointing patterns utilizing tiles (square or rectangular) where the side being offset is greater than 18" (nominal dimension), the running bond offset will be a maximum of 33% unless otherwise specified by the tile manufacturer. If an offset greater than 33% is specified, specifier and owner must approve mock-up and lippage.



Sustainability Attributes

- Red List Free
- Health Product Declaration (HPD) provided upon request
- Product Packaging is 100% recyclable
- VOC Free

*For more information visit www.emser.com. Always consult a professional for proper usage and installation.

Cool and clean, Style II™ offers multiple sizes and a linear mosaic for a contemporary installation perfect for any application.

STYLE II™

Glazed Porcelain







Alps



Vadret

Sizes							
	24" x 24" 23.62" x 23.62"	12" x 24" 11.61" x 23.62"	3" x 12" Floor SBN				
Thickness	8.2mm	8.2mm	9mm				
Faces	6	20	N/A				
Finish	Polished	Polished	Polished				
Edge	Rectified	Rectified	Cut/Rounded				
Grout Joint Recommendation	3/16"	3/16"	3/16"				
Testing	Abrasion Resistance C1027	Breaking Strength C648	Chemical Resistance C650	Water Absorption C373	DCOF ANSI A1371	Scratch Hardness MOHS	Shade Variation Rating
	III	>350 lbf	Resistant	<0.50%	<0.42	3	V2

Product and Installation Details | ANSI A108.02
 Section 4.3.8.2 - For running bond/brick jointing patterns utilizing tiles (square or rectangular) where the side being offset is greater than 18" (nominal dimension), the running bond offset will be a maximum of 33% unless otherwise specified by the tile manufacturer. If an offset greater than 33% is specified, specifier and owner must approve mock-up and lippage.



 Sustainability Attributes

- Red List Free
- Health Product Declaration (HPD) provided upon request
- Product Packaging is 100% recyclable
- VOC Free

*For more information visit www.emser.com. Always consult a professional for proper usage and installation.

Recreate the elegant look of marble and stone and add a touch of elegance and natural beauty to any space.

SWEDEN™
Glazed Porcelain









FLOOR / WALL  RESIDENTIAL  COMMERCIAL  INDOOR  OUTDOOR 



Rhone

Mosaics



Sizes							
	32" x 32" 31.50" x 31.50"	24" x 47" 23.62" x 47.24"	12" x 23" (M) 11.81" x 23.62"	11" x 23" (P) 11.22" x 23.43"	12" x 12" Mesh 12.01" x 12.01"	3" x 12" Floor SBN	
Thickness	10mm	10mm	10mm	10mm	10mm	10mm	
Faces	20	20	20	20	N/A	N/A	
Finish	Polished	Polished	Matte	Polished	Matte & Polished	Matte & Polished	
Edge	Rectified	Rectified	Rectified	Rectified	Cut	Cut/Rounded	
Grout Joint Recommendation	3/16"	3/16"	3/16"	3/16"	3/16"	3/16"	
Testing	Abrasion Resistance C1027	Breaking Strength C648	Chemical Resistance C650	Water Absorption C373	DCOF ANSI A1371	Scratch Hardness MOHS	Shade Variation Rating
	IV (Matte) III (Polished)	>700 lbf	Resistant	<0.50%	>0.65 (Matte) <0.42 (Polished)	6 (Matte) 5 (Polished)	V2

Product and Installation Details | ANSI A108.02
Section 4.3.8.2 - For running bond/brick jointing patterns utilizing tiles (square or rectangular) where the side being offset is greater than 18" (nominal dimension), the running bond offset will be a maximum of 33% unless otherwise specified by the tile manufacturer. If an offset greater than 33% is specified, specifier and owner must approve mock-up and lippage.



 Sustainability Attributes

- Red List Free
- Health Product Declaration (HPD) provided upon request
- Product Packaging is 100% recyclable
- VOC Free
- Recycled Content 0% Pre- & Post-Consumer

*For more information visit www.emser.com. Always consult a professional for proper usage and installation.

Swiss II™ radiates sophisticated beauty highlighting the soft veining of natural stone in a porcelain tile. With polished and matte finishes in multiple sizes, the design possibilities are limitless.

SWISS II™

Glazed Porcelain



FLOOR / WALL  RESIDENTIAL  COMMERCIAL  INDOOR  OUTDOOR 



Bianco



Ivory



Dove



Carbon

Mosaics



Bianco

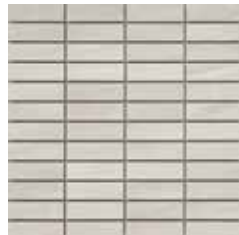



Ivory



Dove

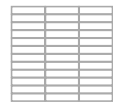

Carbon

Sizes							
	12" x 24" 12.2" x 24.02"	12" x 12" Mesh	3" x 12" Floor SBN				
Thickness	9mm	9.5mm	9mm				
Faces	16	N/A	N/A				
Finish	Matte	Matte	Matte				
Edge	Pressed	Cut	Cut/Rounded				
Grout Joint Recommendation	1/8"	1/8"	1/8"				
Testing	Abrasion Resistance C1027	Breaking Strength C648	Chemical Resistance C650	Water Absorption C373	DCOF ANSI A1371	Scratch Hardness MOHS	Shade Variation Rating
	IV	>375 lbf	Resistant	<0.50%	>0.65	7	V2

Product and Installation Details | ANSI A108.02
Section 4.3.8.2 - For running bond/brick jointing patterns utilizing tiles (square or rectangular) where the side being offset is greater than 18" (nominal dimension), the running bond offset will be a maximum of 33% unless otherwise specified by the tile manufacturer. If an offset greater than 33% is specified, specifier and owner must approve mock-up and lippage.



 Sustainability Attributes

- Red List Free
- Health Product Declaration (HPD) provided upon request
- Product Packaging is 100% recyclable
- VOC Free

*For more information visit www.emser.com. Always consult a professional for proper usage and installation.

Technique™ showcases the intricate veining in natural stone. Offered in contemporary colors it will add charm to any installation.

TECHNIQUE™

Glazed Porcelain



FLOOR / WALL

RESIDENTIAL

COMMERCIAL

INDOOR



Bianco





Gesso



Palladio



Nero

Sizes							
	24" x 24" 23.62" x 23.62"	12" x 24" 12.2" x 24.02"	3" x 24" Floor SBN				
Thickness	10mm	10mm	10mm				
Faces	8	16	N/A				
Finish	Polished	Matte	Matte & Polished				
Edge	Pressed	Rectified	Cut/Rounded				
Grout Joint Recommendation	3/16"	1/8"	1/8"				
Testing	Abrasion Resistance C1027	Breaking Strength C648	Chemical Resistance C650	Water Absorption C373	DCOF ANSI A1371	Scratch Hardness MOHS	Shade Variation Rating
	III	≥250 lbf	Resistant	≤0.50%	≥0.42	6	V2

Product and Installation Details | ANSI A108.02
Section 4.3.8.2 - For running bond/brick jointing patterns utilizing tiles (square or rectangular) where the side being offset is greater than 18" (nominal dimension), the running bond offset will be a maximum of 33% unless otherwise specified by the tile manufacturer. If an offset greater than 33% is specified, specifier and owner must approve mock-up and lippage.



Sustainability Attributes

- Red List Free
- Health Product Declaration (HPD) provided upon request
- Product Packaging is 100% recyclable
- VOC Free

*For more information visit www.emser.com. Always consult a professional for proper usage and installation.



Terazio™ is an alluring recreation of quartz-like attributes in a durable porcelain tile. High-definition inkjets create natural speckled variations on the surface in neutral earth tones. Terazio provides a smooth, luminous finish for residential and commercial applications.

TERAZIO™

Glazed Porcelain



FLOOR / WALL  RESIDENTIAL  COMMERCIAL  INDOOR 

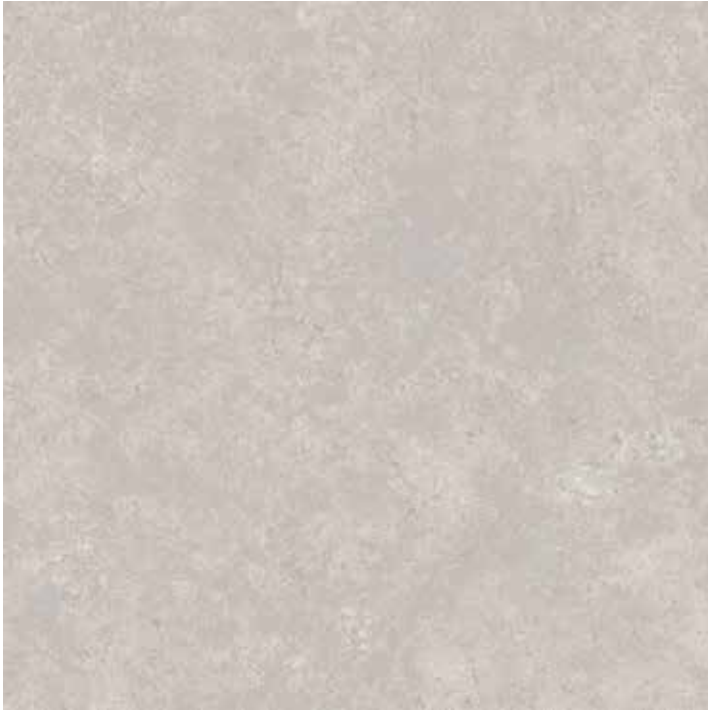

Silver



Taupe





Mosaics



Silver



Taupe

Sizes							
	18" x 18" 17.60" x 17.60"	12" x 12" 12.28" x 12.28"	12" x 12" Mesh 12.28" x 12.28"	3" x 12" Floor SBN			
Thickness	8.4mm	8mm	8mm	7mm			
Faces	8	8	N/A	N/A			
Finish	Matte	Matte	Matte	Matte			
Edge	Pressed	Pressed	Cut	Cut/Rounded			
Grout Joint Recommendation	3/16"	3/16"	3/16"	3/16"			
Testing	Abrasion Resistance C1027	Breaking Strength C648	Chemical Resistance C650	Water Absorption C373	DCOF ANSI A1371	Scratch Hardness MOHS	Shade Variation Rating
	III	≥250 lbf	Not Resistant	≤0.50%	>7.0%	7	V2

 Sustainability Attributes

- Red List Free
- Health Product Declaration (HPD) provided upon request
- Product Packaging is 100% recyclable
- VOC Free

*For more information visit www.emser.com. Always consult a professional for proper usage and installation.

Tesola™ presents the subtle look of concrete in soft neutral colors. This fast trending look is offered in two sizes and coordinating mosaics.

TESOLA™

Glazed Ceramic

FLOOR / WALL

RESIDENTIAL

COMMERCIAL

INDOOR

OUTDOOR



Gray



Taupe



Brown

Sizes



8" x 45"
7.89" x 44.88"

Thickness

10.5mm

Faces

12

Finish

Matte

Edge

Rectified

Grout Joint Recommendation

3/16"

Testing

Abrasion Resistance
C1027

Breaking Strength
C648

Chemical Resistance
C650

Water Absorption
C373

DCOF ANSI
A1371

Scratch Hardness
MOHS

Shade Variation
Rating

Results*

IV

≥700 lbf

Resistant

≤0.50%

≥0.55

6

V2

Product and Installation Details | ANSI A108.02
Section 4.3.8.2 - For running bond/brick joining patterns utilizing tiles (square or rectangular) where the side being offset is greater than 18" (nominal dimension), the running bond offset will be a maximum of 33% unless otherwise specified by the tile manufacturer. If an offset greater than 33% is specified, specifier and owner must approve mock-up and lippage.



Sustainability Attributes

- Red List Free
- Health Product Declaration (HPD) provided upon request
- Product Packaging is 100% recyclable
- VOC Free

*For more information visit www.emser.com. Always consult a professional for proper usage and installation.

Theory™ is a glazed porcelain series inspired by the look of distressed wood, adding interest to any floor or wall application.

THEORY™

Glazed Porcelain



FLOOR / WALL  RESIDENTIAL  COMMERCIAL  INDOOR 



White



Oyster



Silver



Twilight

Mosaics



White



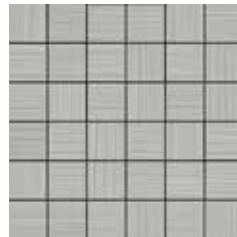

Oyster



Silver

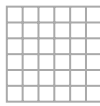

Twilight

Sizes							
	12"x24"	12"x12" Mesh 11.81"x11.81"	3"x12" Floor SBN				
Thickness	9mm	9mm	9mm				
Faces	1	N/A	N/A				
Finish	Matte	Matte	Matte				
Edge	Rectified	Cut	Cut/Rounded				
Grout Joint Recommendation	1/8"	Check Website	Check Website				
Testing	Abrasion Resistance C1027	Breaking Strength C648	Chemical Resistance C650	Water Absorption C373	DCOF ANSI A1371	Scratch Hardness MOHS	Shade Variation Rating
	III	>325 lbf	Resistant	<0.50%	>0.42	7	V1

Product and Installation Details | ANSI A108.02
Section 4.3.8.2 - For running bond/brick joining patterns utilizing tiles (square or rectangular) where the side being offset is greater than 18" (nominal dimension), the running bond offset will be a maximum of 33% unless otherwise specified by the tile manufacturer. If an offset greater than 33% is specified, specifier and owner must approve mock-up and lippage.



 Sustainability Attributes

- Red List Free
- Health Product Declaration (HPD) provided upon request
- Product Packaging is 100% recyclable
- VOC Free
- 0% Pre- & Post-Consumer

*For more information visit www.emser.com. Always consult a professional for proper usage and installation.

Inspired by woven textiles, Thread II™ offers a subtle color palette with coordinating mosaics.

THREAD II™

Glazed Porcelain



FLOOR / WALL  RESIDENTIAL  INDOOR 



Beige



Silver



Noce

Mosaics





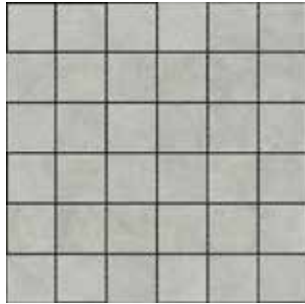

Beige



Silver



Noce

Sizes							
	17" x 17" 17,30" x 17,30"	13" x 13" 13,10" x 13,10"	13" x 13" Mesh 12,99" x 12,99"	3" x 13" Floor SBN			
Thickness	9mm	7,7mm	9mm	7,7mm			
Faces	4	4	N/A	N/A			
Finish	Matte	Matte	Matte	Matte			
Edge	Pressed	Pressed	Cut	Cut/Rounded			
Grout Joint Recommendation	1/8"	1/8"	3/16"	3/16"			
Testing	Abrasion Resistance C1027	Breaking Strength C648	Chemical Resistance C650	Water Absorption C373	DCOF ANSI A1371	Scratch Hardness MOHS	Shade Variation Rating
	III	≥250 lbf	Non-Resistant	≤5%	≥0.42%	7	V2

 Sustainability Attributes

- Red List Free
- Health Product Declaration (HPD) provided upon request
- Product Packaging is 100% recyclable
- VOC Free

*For more information visit www.emser.com. Always consult a professional for proper usage and installation.

With subtle veining and rich earthy colors, Toledo™, a glazed ceramic tile series, recalls age old stone in traditional sizes and colors.

TOLEDO™

Glazed Ceramic



FLOOR / WALL  RESIDENTIAL  COMMERCIAL  INDOOR  OUTDOOR  POOL 



White



Almond





Steel



Ocean



Taupe

Sizes							
	12" x 35" 11.71" x 35.3"	12" x 24" 11.71" x 23.50"	3" x 12" Floor SBN				
Thickness	8mm	9.5mm	Check Website				
Faces	8	32	N/A				
Finish	Matte	Matte	Matte				
Edge	Rectified	Rectified	Cut/Rounded				
Grout Joint Recommendation	1/8"	1/8"	1/8"				
Testing	Abrasion Resistance C1027	Breaking Strength C648	Chemical Resistance C650	Water Absorption C373	DCOF ANSI A1371	Scratch Hardness MOHS	Shade Variation Rating
	Results*	II	>350 lbf	Resistant	<0.50%	>0.60	7

Product and Installation Details | ANSI A108.02
 Section 4.3.8.2 - For running bond/brick jointing patterns utilizing tiles (square or rectangular) where the side being offset is greater than 18" (nominal dimension), the running bond offset will be a maximum of 33% unless otherwise specified by the tile manufacturer. If an offset greater than 33% is specified, specifier and owner must approve mock-up and lippage.



 Sustainability Attributes

- Red List Free
- Health Product Declaration (HPD) provided upon request
- Product Packaging is 100% recyclable
- VOC Free



*For more information visit www.emser.com. Always consult a professional for proper usage and installation.

Trendz™ takes fashion to a new level by combining sophisticated colors with subtle shimmer. The result is undeniably beautiful. From the cool ocean blue to the contemporary steel gray, Trendz is sure to have a look to match any decor. Available in two sizes including a large 12x35 plank and is ideal for any room where a twist on traditional looks is desired.

TRENDZ™

Glazed Porcelain



FLOOR / WALL  RESIDENTIAL  COMMERCIAL  INDOOR  OUTDOOR 



Album



Diary



Journal



Ledger

Mosaics



Album

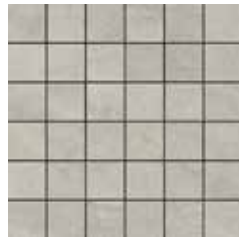





Diary



Journal



Ledger

Sizes							
	21" x 21" 21.38" x 21.38"	13" x 13" 13.07" x 13.07"	12" x 24" 12.2" x 24.02"	13" x 13" Mesh	3" x 13" Floor SBN		
Thickness	8.5mm	8mm	8.5mm	8.5mm	8mm		
Faces	8	16	16	N/A	N/A		
Finish	Matte	Matte	Matte	Matte	Matte		
Edge	Pressed	Pressed	Pressed	Cut	Cut/Rounded		
Grout Joint Recommendation	1/8"	1/8"	1/8"	1/8"	1/8"		
Testing	Abrasion Resistance C1027	Breaking Strength C648	Chemical Resistance C650	Water Absorption C373	DCOF ANSI A1371	Scratch Hardness MOHS	Shade Variation Rating
	IV	>380 lbf	Resistant	<0.50%	>0.55	7	V3

Product and Installation Details | ANSI A108.02
Section 4.3.8.2 - For running bond/brick jointing patterns utilizing tiles (square or rectangular) where the side being offset is greater than 18" (nominal dimension), the running bond offset will be a maximum of 33% unless otherwise specified by the tile manufacturer. If an offset greater than 33% is specified, specifier and owner must approve mock-up and lippage.



 Sustainability Attributes

- Red List Free
- Health Product Declaration (HPD) provided upon request
- Product Packaging is 100% recyclable
- VOC Free

*For more information visit www.emser.com. Always consult a professional for proper usage and installation.

Trovata II™ beautifully recreates the look of stone in glazed porcelain with rustic undertones. Using high definition printing technology, Trovata II™ consists of four colors and coordinating mosaics.

TROVATA II™

Glazed Porcelain





Kyoto



Osaka



Tokyo

Sizes Thickness Faces Finish Edge Grout Joint Recommendation							
	8" x 24" 795" x 2370"						
	8.6mm						
	8						
	Matte						
	Pressed						
3/16"							
Testing	Abrasion Resistance <small>C1027</small>	Breaking Strength <small>C648</small>	Chemical Resistance <small>C650</small>	Water Absorption <small>C373</small>	DCOF ANSI <small>A1371</small>	Scratch Hardness <small>MOHS</small>	Shade Variation Rating
Results*	III	>250 lbf	Resistant	<10.0%	>0.45	7	V2

Product and Installation Details | ANSI A108.02
 Section 4.3.8.2 - For running bond/brick jointing patterns utilizing tiles (square or rectangular) where the side being offset is greater than 18" (nominal dimension), the running bond offset will be a maximum of 33% unless otherwise specified by the tile manufacturer. If an offset greater than 33% is specified, specifier and owner must approve mock-up and lippage.



Sustainability Attributes

- Red List Free
- Health Product Declaration (HPD) provided upon request
- Product Packaging is 100% recyclable
- VOC Free

*For more information visit www.emser.com. Always consult a professional for proper usage and installation.

Uddo™ represents the look of wood in a glazed ceramic tile evoking layers of texture and natural graining. The warm, neutral tones will enhance the beauty of any space.

UDDO™
Glazed Ceramic



FLOOR / WALL

RESIDENTIAL

COMMERCIAL

INDOOR

OUTDOOR



Sugar Hill



Manhattan



Morningside



Hamilton



Hudson



Washington

Mosaics

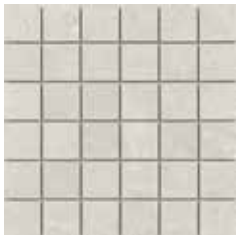

Sugar Hill



Manhattan



Morningside



Hamilton



Hudson

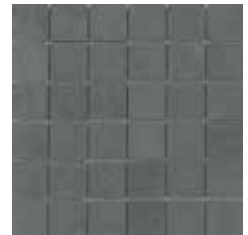

Washington

Sizes							
	24"x47" 24.02"x47.24"	24"x24" 24.02"x24.02"	12"x24" 12.2"x24.02"	12"x12" Mesh 11.81"x11.81"	3"x12" Floor SBN		
Thickness	10mm	9mm	9.5mm	10mm	9.5mm		
Faces	6	20	24	N/A	N/A		
Finish	Matte	Matte	Matte	Matte	Matte		
Edge	Rectified	Rectified	Rectified	Cut	Cut/Rounded		
Grout Joint Recommendation	1/8"	1/8"	1/8"	5/64"	5/64"		
Testing	Abrasion Resistance C1027	Breaking Strength C648	Chemical Resistance C650	Water Absorption C373	DCOF ANSI A1371	Scratch Hardness MOHS	Shade Variation Rating
	IV	≥850 lbf	Resistant	≤0.50%	≥0.65	7	V2

Product and Installation Details | ANSI A108.02 Section 4.3.8.2 - For running bond/brick jointing patterns utilizing tiles (square or rectangular) where the side being offset is greater than 18" (nominal dimension), the running bond offset will be a maximum of 33% unless otherwise specified by the tile manufacturer. If an offset greater than 33% is specified, specifier and owner must approve mock-up and lippage.



Sustainability Attributes

- Red List Free
- Health Product Declaration (HPD) provided upon request
- Product Packaging is 100% recyclable
- VOC Free

*For more information visit www.emser.com. Always consult a professional for proper usage and installation.





Uptown™ features subtle textures and color variation giving it a timeless, urban feel. All colors are offered in a coordinating mosaic for a variety of installation options.

UPTOWN™

Glazed Body Match Porcelain



FLOOR / WALL  RESIDENTIAL  COMMERCIAL  INDOOR 







Groven



Ribia



Varzo

Sizes							
	24" x 47" 23.62" x 47.24"	24" x 24" 23.62" x 23.62"	12" x 24" 11.81" x 23.62"	3" x 12" Floor SBN			
Thickness	12mm	10mm (Matte) 9.5mm (Polished)	9mm (Matte) 9.2mm (Polished)	Check Website			
Faces	6	10	12-17	N/A			
Finish	Matte & Polished	Matte & Polished	Matte & Polished				
Edge	Rectified	Rectified	Rectified	Cut/Rounded			
Grout Joint Recommendation	1/8"	1/8"	1/8"	Check Website			
Testing	Abrasion Resistance C1027	Breaking Strength C648	Chemical Resistance C650	Water Absorption C373	DCOF ANSI A1371	Scratch Hardness MOHS	Shade Variation Rating
	Check Website	Check Website	Check Website	Check Website	Check Website	Check Website	V3

Product and Installation Details | ANSI A108.02
 Section 4.3.8.2 - For running bond/brick jointing patterns utilizing tiles (square or rectangular) where the side being offset is greater than 18" (nominal dimension), the running bond offset will be a maximum of 33% unless otherwise specified by the tile manufacturer. If an offset greater than 33% is specified, specifier and owner must approve mock-up and lippage.



 Sustainability Attributes

- Red List Free
- Health Product Declaration (HPD) provided upon request
- Product Packaging is 100% recyclable
- VOC Free
- Recycled Content >40% Pre-Consumer, >10% Post-Consumer

*For more information visit www.emser.com. Always consult a professional for proper usage and installation.



Vara™ takes its inspiration from the natural beauty of marble. This stunning line evokes the luxurious look of natural stone but with the easy care of porcelain tile. The subtle veining and crisp coloring creates a stylish environment.

VARA™
Glazed Porcelain



FLOOR / WALL  RESIDENTIAL  COMMERCIAL  INDOOR 



Force



Rate

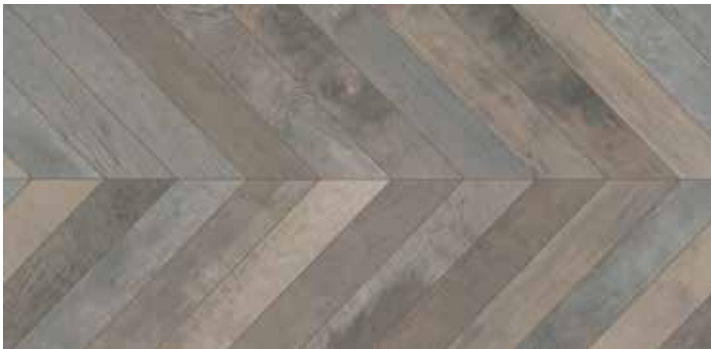

Pulse

Sizes Thickness Faces Finish Edge Grout Joint Recommendation							
	17" x 35" 17.40" x 35.04"						
	11mm						
	3						
	Matte						
Rectified							
1/16"							
Testing	Abrasion Resistance C1027	Breaking Strength C648	Chemical Resistance C650	Water Absorption C373	DCOF ANSI A1371	Scratch Hardness MOHS	Shade Variation Rating
Results*	IV	≥650 lbf	Resistant	<0.50%	>0.55	9	V2

Product and Installation Details | ANSI A108.02
 Section 4.3.8.2 - For running bond/brick jointing patterns utilizing tiles (square or rectangular) where the side being offset is greater than 18" (nominal dimension), the running bond offset will be a maximum of 33% unless otherwise specified by the tile manufacturer. If an offset greater than 33% is specified, specifier and owner must approve mock-up and lippage.



 Sustainability Attributes

- Red List Free
- Health Product Declaration (HPD) provided upon request
- Product Packaging is 100% recyclable
- VOC Free

*For more information visit www.emser.com. Always consult a professional for proper usage and installation.

Velocity™ uniquely displays the varied colors and textures of distressed wood. A popular chevron pairs natural and painted wood tones for rustic, yet modern appeal. Plank tiles invite creative layouts for geometric designs that play on patterns.

VELOCITY™

Glazed Porcelain



FLOOR / WALL

RESIDENTIAL

COMMERCIAL

INDOOR

OUTDOOR



Gray



Latte

Sizes



8" x 4.7"
7.87" x 4.724"

Thickness

8mm

Faces

16

Finish

Matte

Edge

Pressed

Grout Joint Recommendation

3/16"

Product and Installation Details | ANSI A108.02
Section 4.3.8.2 - For running bond/brick jointing patterns utilizing tiles (square or rectangular) where the side being offset is greater than 18" (nominal dimension), the running bond offset will be a maximum of 33% unless otherwise specified by the tile manufacturer. If an offset greater than 33% is specified, specifier and owner must approve mock-up and lippage.

Testing	Abrasion Resistance C1027	Breaking Strength C648	Chemical Resistance C650	Water Absorption C373	DCOF ANSI A1371	Scratch Hardness MOHS	Shade Variation Rating
Results*	IV	526 lbf	Resistant	0.40%	Check Website	7	V3



Recommended 33% Offset*

Sustainability Attributes

- Red List Free
- Health Product Declaration (HPD) provided upon request
- Product Packaging is 100% recyclable
- VOC Free

*For more information visit www.emser.com. Always consult a professional for proper usage and installation.

Quietly sophisticated with all the inherent benefits of tile, that's the story behind Victus™. Natural wood looks add warmth and comfort, whether your style leans more modern and minimal or traditional and timeless.

VICTUS™
Glazed Porcelain



FLOOR / WALL  RESIDENTIAL  COMMERCIAL  INDOOR  OUTDOOR 



White





Ivory



Gray



Sizes		
	18" x 18" 16,50" x 17,30"	8,44 cm 3,32"
Thickness	9mm	
Faces	4	
Finish	Matte	
Edge	Pressed	
Grout Joint Recommendation	1/8"	

Testing	Abrasion Resistance C1027	Breaking Strength C648	Chemical Resistance C650	Water Absorption C373	DCOF ANSI A1371	Scratch Hardness MOHS	Shade Variation Rating
Results*	IV	≥400 lbf	Resistant	<0.50%	≥0.60	9	V2

 Sustainability Attributes

- Red List Free
- Health Product Declaration (HPD) provided upon request
- Product Packaging is 100% recyclable
- VOC Free

*For more information visit www.emser.com. Always consult a professional for proper usage and installation.

Virtue™ features interlocking tiles that seamlessly connect for a consistent hexagon shape. Its eclectic mix of ornate patterns and smooth textures add an accent pop, or bold, all-over patterning. An octagonal shape blends the craftsmanship of a mosaic with the ease of larger-format tiles.

VIRTUE™

Glazed Porcelain



FLOOR / WALL  RESIDENTIAL  COMMERCIAL  INDOOR  OUTDOOR  POOL 





Trav Silver



Trav Beige



Cemento Gray

Sizes							
	24" x 24" 23.62" x 23.62"	12" x 24" Coping					
Thickness	20mm	20mm					
Faces	12 (Travertine) 8 (Cemento)	24 (Travertine) 16 (Cemento)					
Finish	Matte	Matte					
Edge	Rectified	Rectified					
Grout Joint Recommendation	1/8"	3/16"					
Testing	Abrasion Resistance C1027	Breaking Strength C648	Chemical Resistance C650	Water Absorption C373	DCOF ANSI A1371	Scratch Hardness MOHS	Shade Variation Rating
	Results* V	≥500 lbf	Resistant	≤0.50%	>0.65	7	V2

Product and Installation Details | ANSI A108.02
Section 4.3.8.2 - For running bond/brick jointing patterns utilizing tiles (square or rectangular) where the side being offset is greater than 18" (nominal dimension), the running bond offset will be a maximum of 33% unless otherwise specified by the tile manufacturer. If an offset greater than 33% is specified, specifier and owner must approve mock-up and lippage.



 Sustainability Attributes

- Red List Free
- Health Product Declaration (HPD) provided upon request
- Product Packaging is 100% recyclable
- VOC Free

*For more information visit www.emser.com. Always consult a professional for proper usage and installation.

Xtra™ replicates the look of concrete and stone in multiple colors. This unique collection is suitable for indoor and outdoor spaces.

XTRA™
Glazed Porcelain

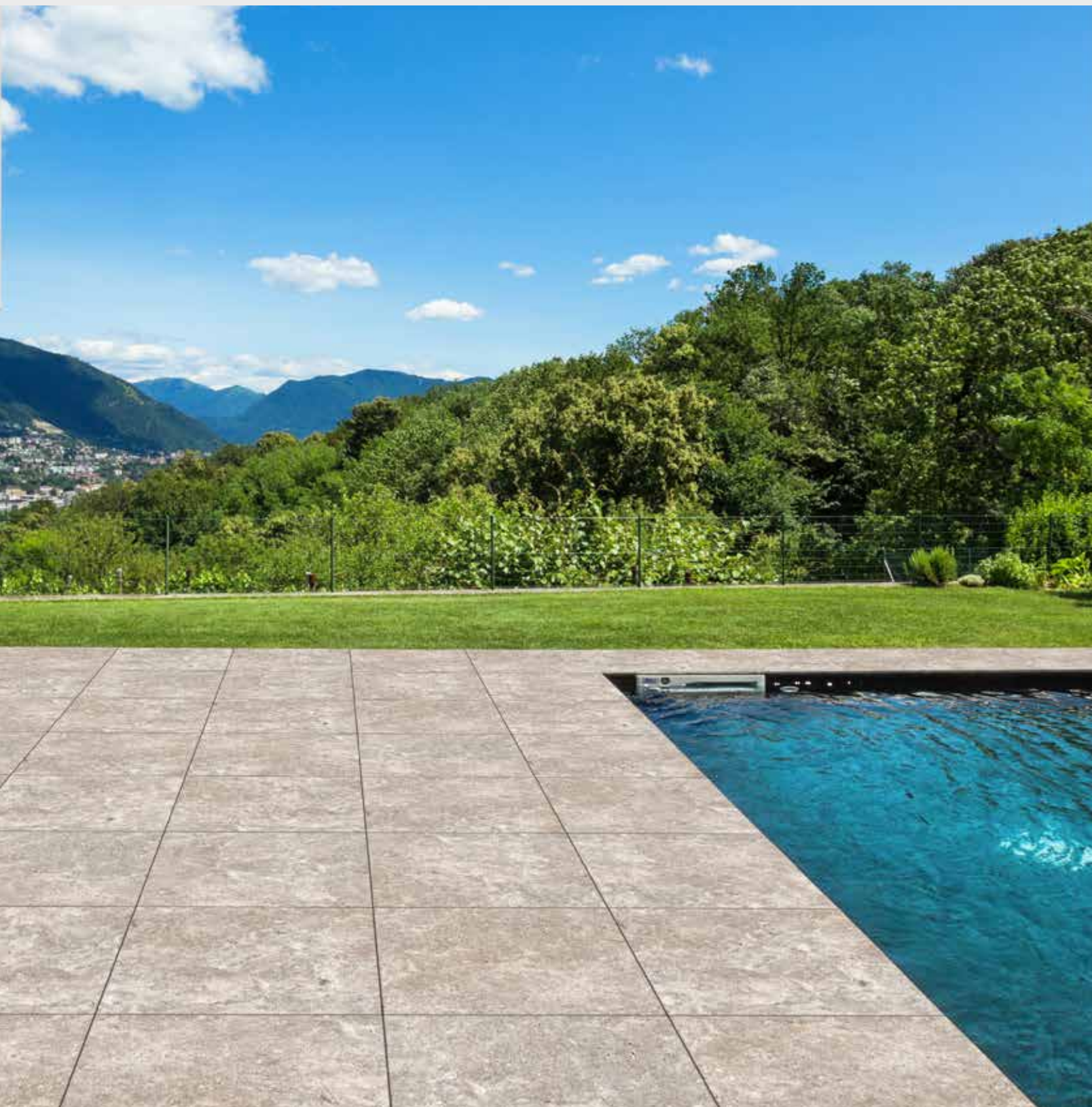



Hues™ • White 3" x 10"



WALL TILE



Pearl Wave



Metal Wave



Plain White



White Mini Hexagon



Silver Mini Hexagon

Sizes					
	12" x 35" 11.81" x 35.43"				
Thickness	Plain: 8mm, Wave: 25mm, Mini Hex: 10mm				
Grout Joint Recommendation	1/16"				
Testing	Breaking Strength C648	Chemical Resistance C650	Water Absorption C373	Scratch Hardness MOHS	Shade Variation Rating
Results*	≤250 lbf	Resistant	>7%	4	V1

- Sustainability Attributes**
- Health Product Declaration (HPD) provided upon request
 - Product Packaging is 100% recyclable
 - VOC Free
 - Recycled Content 74% Pre-Consumer & 0% Post-Consumer

*For more information visit www.emser.com. Always consult a professional for proper usage and installation.

Artwork™ features dimensional wave and hexagon patterns for a design-forward artistic statement. Contemporary glossy finish and metallics in large format tiles bring heightened glamour.

ARTWORK™

Glazed Ceramic



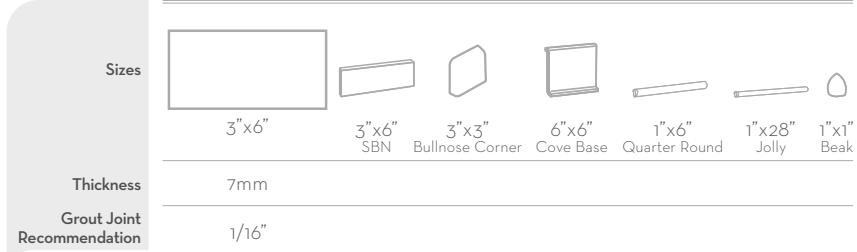

Testing	Breaking Strength C648	Chemical Resistance C650	Water Absorption C373	Scratch Hardness MOHS	Shade Variation Rating
Results*	>125 lbf	Resistant	<20.0%	4	Check Website

- Sustainability Attributes**
- Health Product Declaration (HPD) provided upon request
 - Product Packaging is 100% recyclable
 - VOC Free

*For more information visit www.emser.com. Always consult a professional for proper usage and installation.
Designed in collaboration with Gensler™ as product design consultant



A simple yet robust collection that can stand on its own or serve as a backbone to complement other collections. A range of cool, warm and neutral colors available in a basic shape enables everything from pure color fields to complex ombre effects.

BACK TO BASICS™

Glazed Ceramic



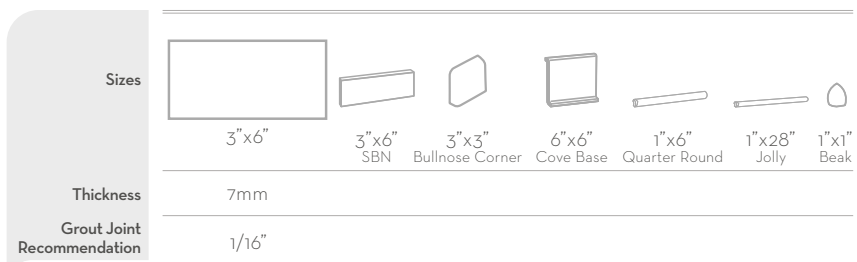

Testing	Breaking Strength C648	Chemical Resistance C650	Water Absorption C373	Scratch Hardness MOHS	Shade Variation Rating
Results*	>125 lbf	Resistant	<20.0%	4	Check Website

- Sustainability Attributes**
- Health Product Declaration (HPD) provided upon request
 - Product Packaging is 100% recyclable
 - VOC Free

*For more information visit www.emser.com. Always consult a professional for proper usage and installation.
Designed in collaboration with Gensler™ as product design consultant

A simple yet robust collection that can stand on its own or serve as a backbone to complement other collections. A range of cool, warm and neutral colors available in a basic shape enables everything from pure color fields to complex ombre effects.

BACK TO BASICS™

Glazed Ceramic





Ariston



Helicon



Mistral



Naya

Sizes Thickness Grout Joint Recommendation						
	8" x 24" 791 x 23,68"					
	9mm					
		1/8"				
Testing	Breaking Strength C648	Chemical Resistance C650	Water Absorption C373	Scratch Hardness MOHS	Shade Variation Rating	
Results*	Check Website	Check Website	Check Website	Check Website	V2	

- Sustainability Attributes**
- Health Product Declaration (HPD) provided upon request
 - Product Packaging is 100% recyclable
 - VOC Free

*For more information visit www.emser.com. Always consult a professional for proper usage and installation.

Take the allure of stained concrete and elevate it with Bimova™ ceramic tile. Each unique cool neutral takes its namesake from Greek mythology, celebrating natural elements of wind and water, as well as ancient philosophers. And while the collection may take inspiration from the past, its look reflects modern industrial design for inviting atmospheres.

BIMOVA™

Glazed Ceramic



Ice



Ivory



Gray



Fawn



Taupe



Silicon

All Colors Available in Matte & Gloss Finish
6"x6" Available in Ice Gloss Only



Catch™ | Ice

Sizes								Trim
	2"x8"	3"x6" 2.95"x5.91"	3"x12" 2.95"x11.81"	4"x10" 3.94"x9.84"	4"x16" 3.94"x15.75"	6"x18" 5.91"x17.72"	6"x6" 5.91"x5.91"	
Thickness	Check Website	7mm	7.6mm	8mm	7.6mm	8mm	7mm	
Grout Joint Recommendation	Check Website	1/8"	1/8"	1/8"	1/8"	1/8"	1/8"	
Testing	Breaking Strength C648	Chemical Resistance C650	Water Absorption C373	Scratch Hardness MOHS	Shade Variation Rating	Sustainability Attributes <ul style="list-style-type: none"> • Health Product Declaration (HPD) provided upon request • Product Packaging is 100% recyclable • VOC Free • Recycled Content 0% Pre- & Post-Consumer 		
Results*	>150 lbf	Resistant	<20.0%	3	V1			

*For more information visit www.emser.com. Always consult a professional for proper usage and installation.

Catch™, a glazed ceramic wall tile that will capture your imagination and inspire truly one-of-a-kind designs. Available in six sizes and both a matte and glossy finish, this is no ordinary subway tile. The cool color tones are reminiscent of ocean waves and bring a sense of serenity to any room.

CATCH™

Glazed Ceramic

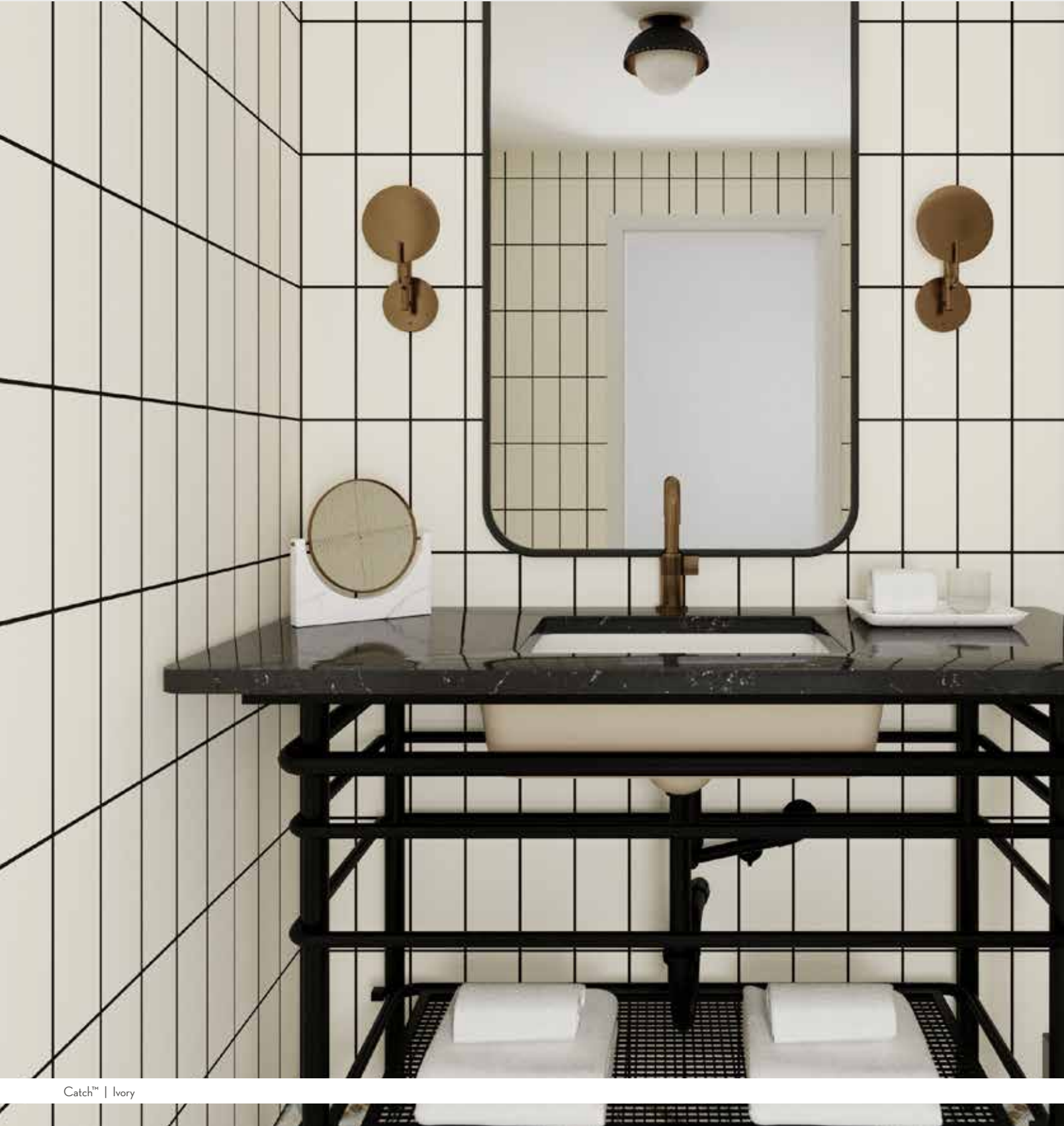



Hex White



Linear White



Wood White

Sizes Thickness Grout Joint Recommendation						
	13" x 36" 12.99" x 35.83"					
	10mm					
Testing		Breaking Strength C648	Chemical Resistance C650	Water Absorption C373	Scratch Hardness MOHS	Shade Variation Rating
Results*		<250 lbf	Resistant	>7%	5	V1

- Sustainability Attributes**
- Health Product Declaration (HPD) provided upon request
 - Product Packaging is 100% recyclable
 - VOC Free
 - Recycled Content 0% Pre- & Post-Consumer

*For more information visit www.emser.com. Always consult a professional for proper usage and installation.

Center™ embraces the harmony of texture and shape. Hex, linear, and wood-inspired motifs act as a design springboard with visual interest. Neutral large format tiles support entire wall and select surface applications.

CENTER™

Glazed Ceramic







White Bevel



Fawn Bevel



Gray Bevel

SIZES	 				
	4" x 12" 3.94" x 11.81"	3" x 6" 2.95" x 5.91"			
	7.2mm	7.2mm			
THICKNESS					
Grout Joint Recommendation	1/16" Stacked 1/8" Staggered	1/16" Stacked 1/8" Staggered			
TESTING	Breaking Strength C648	Chemical Resistance C650	Water Absorption C373	Scratch Hardness MOHS	Shade Variation Rating
RESULTS*	Check Website	Check Website	Check Website	Check Website	V1

- Sustainability Attributes**
- Health Product Declaration (HPD) provided upon request
 - Product Packaging is 100% recyclable
 - VOC Free
 - Recycled Content 0% Pre- & Post-Consumer

*For more information visit www.emser.com. Always consult a professional for proper usage and installation.

Choice II™ is a smooth, simplistic tile for an unvaried approach to wall design. Solid colors in beveled and glossy finish provide a clean, modern look and allow for endless design opportunities.

CHOICE II™

Glazed Ceramic





White Hexagon Smooth



White Hexagon 3D



White Hexagon High



Metallic Hexagon High



Calacatta Hexagon Smooth



White Wedge Smooth



White Trapezoid

Suitable for Floor, Wall, and Outdoor Application

Sizes	6" x 7" Hexagon 5.89" x 6.77"	5" x 6" Wedge 4.92" x 5.91"	4" x 9" Trapezoid 3.86" x 8.98"		
Thickness	Smooth / 3D / High 8mm / 18mm / 21mm	8mm	8,5mm		
Grout Joint Recommendation	1/8"	1/8"	1/8"		
Testing	Breaking Strength C648	Chemical Resistance C650	Water Absorption C373	Scratch Hardness MOHS	Shade Variation Rating
Results*	<250 lbf	Resistant	>7%	6	V1

- Sustainability Attributes**
- Health Product Declaration (HPD) provided upon request
 - Product Packaging is 100% recyclable
 - VOC Free
 - Recycled Content 0% Pre- & Post-Consumer

*For more information visit www.emser.com. Always consult a professional for proper usage and installation.

The integration of light and shadow effects create dimensional vertical surfaces using simple shapes that shift and transform. Code™ is offered in unique shapes and sizes for a dramatic statement.

CODE™
Glazed Ceramic





White



Ivory



Taupe



Gray



Blue

Sizes Thickness Grout Joint Recommendation					
	10" x 30" 9.84" x 29.53"				
	10.5mm				
Testing	Breaking Strength C648	Chemical Resistance C650	Water Absorption C373	Scratch Hardness MOHS	Shade Variation Rating
Results*	<250 lbf	Resistant	>7%	5	V3

- Sustainability Attributes**
- Health Product Declaration (HPD) provided upon request
 - Product Packaging is 100% recyclable
 - VOC Free
 - Recycled Content 0% Pre- & Post-Consumer

*For more information visit www.emser.com. Always consult a professional for proper usage and installation.

Colori™ embodies modern design by embracing color in a glazed ceramic tile. A glossy finish provides reflective qualities that enhance neutrals and a saturated accent color.

COLORI™

Glazed Ceramic





Coal



Gray



Ivory



White

Sizes Thickness Grout Joint Recommendation					
	6" x 24" 5.91" x 24.02"				
	7-11mm				
3/16"					
Testing	Breaking Strength C648	Chemical Resistance C650	Water Absorption C373	Scratch Hardness MOHS	Shade Variation Rating
Results*	>350 lbf	Resistant	<0.5%	6	V3

- Sustainability Attributes**
- Health Product Declaration (HPD) provided upon request
 - Product Packaging is 100% recyclable
 - VOC Free
 - Recycled Content > 30% Pre-Consumer

*For more information visit www.emser.com. Always consult a professional for proper usage and installation.



The unique design of Connect™ provides the appearance of stacked stone in a durable glazed porcelain tile. The texture and variation found on this tile perfectly captures the beautiful characteristics of natural stone. The warm to cool colorways provide a sense of balance to any application.

CONNECT™

Glazed Porcelain





Taupe



White



Fawn



Gray



Bone



Sage

All Colors Available in Matte & Gloss Finish

Sizes						
	3" x 12" 2.85" x 11.69"	3" x 12" 2.95" x 11.81"	3" x 12" Wall SBN			
Thickness	9mm					
Grout Joint Recommendation	1/16"					
Testing	Breaking Strength C648	Chemical Resistance C650	Water Absorption C373	Scratch Hardness MOHS	Shade Variation Rating	
	Results* >300 lbf	Resistant	6.0% - 10.0%	3	V1	



- Sustainability Attributes
- Health Product Declaration (HPD) provided upon request
 - Product Packaging is 100% recyclable
 - VOC Free
 - Recycled Content 0% Pre- & Post-Consumer

*For more information visit www.emser.com. Always consult a professional for proper usage and installation.

Craft II™ is an intriguing statement tile for a crisp, contemporary approach to wall design. Classic neutrals take on an undulating glossy or matte finish for a refreshing complement to any décor.

CRAFT II™

Glazed Ceramic





Alto





Cumulus



Nimbus



Stratus

Sizes					
	3" x 6" 2.95" x 5.95"	4" x 16" 3.94" x 15.83"	1/2" x 8" Jolly		
Thickness	7mm	7.8mm			
Grout Joint Recommendation	Check Website	Check Website			
Testing	Breaking Strength C648	Chemical Resistance C650	Water Absorption C373	Scratch Hardness MOHS	Shade Variation Rating
Results*	Check Website	Check Website	Check Website	Check Website	V2

- Sustainability Attributes**
- Health Product Declaration (HPD) provided upon request
 - Product Packaging is 100% recyclable
 - VOC Free

*For more information visit www.emser.com. Always consult a professional for proper usage and installation.

Emora™ ceramic tile for walls takes its inspiration from the skies above, with a collection of four named Alto, Cumulus, Nimbus and Stratus. Clouds never fail to fascinate, and the same is true with Emora's collection of unique tiles which combine the simplicity of neutral color with the complexity of texture. Each a unique work of art – together, offering the potential for a signature wall moment.

EMORA™

Glazed Ceramic





Pearl Arrow



Pearl Linear



Pearl Plain



Ocean Arrow

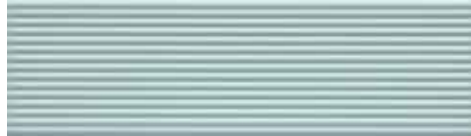

Ocean Linear



Ocean Plain



Ore Arrow



Ore Linear

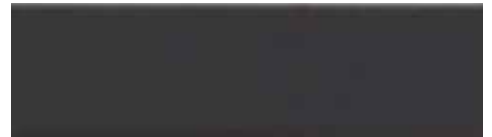

Ore Plain



Silver Arrow



Silver Linear



Silver Plain



Euphoria™ | Pearl Linear

Sizes					
	3" x 12" 2.95" x 11.81"				
Thickness	7.5mm				
Grout Joint Recommendation	1/8"				
Testing	Breaking Strength C648	Chemical Resistance C650	Water Absorption C373	Scratch Hardness MOHS	Shade Variation Rating
Results*	>200 lbf	Resistant	<20.0%	TIP	V1



- Sustainability Attributes**
- Health Product Declaration (HPD) provided upon request
 - Product Packaging is 100% recyclable
 - VOC Free
 - Recycled Content 0% Pre- & Post-Consumer

*For more information visit www.emser.com. Always consult a professional for proper usage and installation.

Euphoria™ provides a high end, art deco look to typical subway tile. Available in four stylish colors including white, ocean blue, silver, and metallic gray, Euphoria™ will complement any décor.

EUPHORIA™

Glazed Ceramic



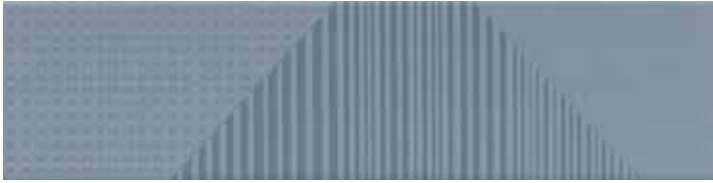

Blue Aglow

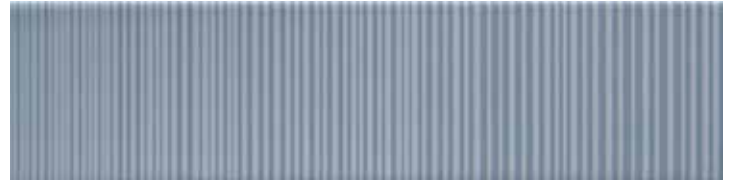

Blue Linear



Blue Burst



Blue Glare



Fawn Aglow



Gray Aglow



White Aglow



Fawn Linear



Gray Linear



White Linear



Fawn Burst



Gray Burst



White Burst



Fawn Glare



Gray Glare



White Glare

Sizes					
	3" x 12" 2.95" x 11.78"				
	Thickness 8.5mm				
Grout Joint Recommendation	1/16"				
Testing	Breaking Strength C648	Chemical Resistance C650	Water Absorption C373	Scratch Hardness MOHS	Shade Variation Rating
Results*	>250 lbf	Resistant	<18.0%	4	V2



- Sustainability Attributes**
- Health Product Declaration (HPD) provided upon request
 - Product Packaging is 100% recyclable
 - VOC Free
 - Recycled Content 0% Pre- & Post-Consumer

*For more information visit www.emser.com. Always consult a professional for proper usage and installation.

With Express™ your inner artist will flourish. The unique patterns allow for either a designed pattern, or mix and match for a truly random, and stylized design. Whether you are a design expert or simply want to look like one, Express™ is the ideal product.

EXPRESS™

Glazed Ceramic





Ivory



Ivory Flat



Gray

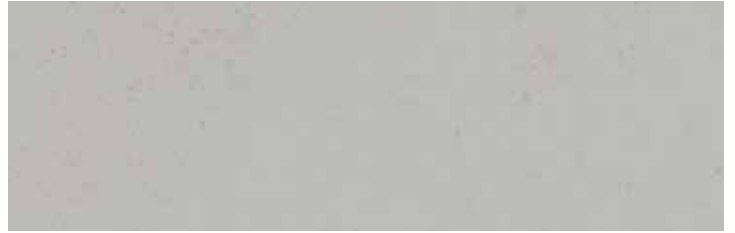

Gray Flat



Charcoal



Charcoal Flat

Sizes Thickness Grout Joint Recommendation					
	6" x 20" 6.42" x 20.35"				
	11.5mm				
Grout Joint Recommendation 3/16"					
Testing	Breaking Strength C648	Chemical Resistance C650	Water Absorption C373	Scratch Hardness MOHS	Shade Variation Rating
Results*	>250 lbf (Flat)	Resistant (Flat)	<0.5% (Flat)	7 (Flat)	V2

- Sustainability Attributes**
- Health Product Declaration (HPD) provided upon request
 - Product Packaging is 100% recyclable
 - VOC Free

*For more information visit www.emser.com. Always consult a professional for proper usage and installation.



Capture the majesty of ancient Greek and Roman civilizations with Fregio™. This ceramic tile harkens to the storied era of conquering empires and brings the look of rugged, chiseled marble to any design.

FREGIO™

Glazed Ceramic





Light



Sage



Gray



Blue



Twine Light



Structure Light

Sizes					
	17" x 47" 16.73" x 46.93"				
Thickness	10mm				
Grout Joint Recommendation	1/8"				
Testing	Breaking Strength C648	Chemical Resistance C650	Water Absorption C373	Scratch Hardness MOHS	Shade Variation Rating
Results*	>350 lbf	Resistant	7.0% - 20%	Check Website	V2

- Sustainability Attributes**
- Health Product Declaration (HPD) provided upon request
 - Product Packaging is 100% recyclable
 - VOC Free
 - Recycled Content 0% Pre- & Post-Consumer

*For more information visit www.emser.com. Always consult a professional for proper usage and installation.



Glow™ makes a striking and beautiful wall design with luminous color and interesting patterns and textures. This large format ceramic tile provides a luxurious option for any installation. Available in four colors and three patterns.

GLOW™
Glazed Ceramic





Brick



Cement



Ebony

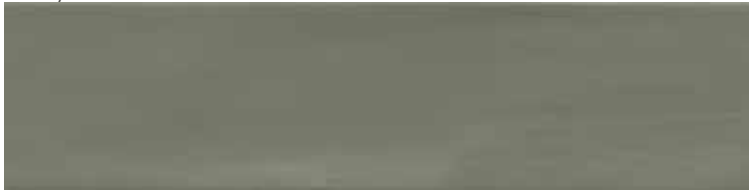



Kale



Linen



White

Sizes					
	3" x 10" 2.56" x 10.24"	1/2" x 12" Jolly 0.59" x 11.81"			
Thickness	9mm	8mm			
Grout Joint Recommendation	1/8"				
Testing	Breaking Strength C648	Chemical Resistance C650	Water Absorption C373	Scratch Hardness MOHS	Shade Variation Rating
Results*	>150 lbf	Resistant	<20.0%	7	V1



- Sustainability Attributes**
- Health Product Declaration (HPD) provided upon request
 - Product Packaging is 100% recyclable
 - VOC Free
 - Recycled Content 30% Pre- & 5% Post-Consumer

*For more information visit www.emser.com. Always consult a professional for proper usage and installation.

Bring a sense of nature to your next design project with Hues™. Available in a wide range of mud-essence colorways, this collection is at once calming and inspiring. While straight edging gives this tile a contemporary feel, the organic surface texture nods to more artisanal roots.

HUES™
Glazed Ceramic



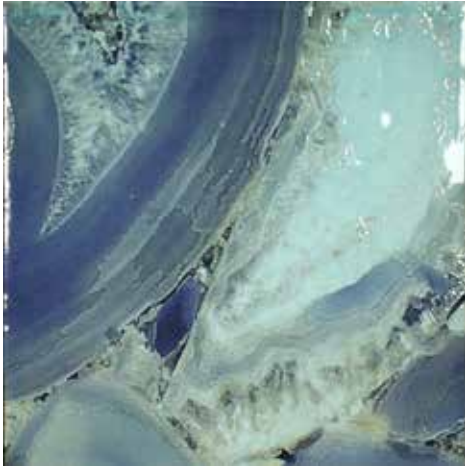

Aqua

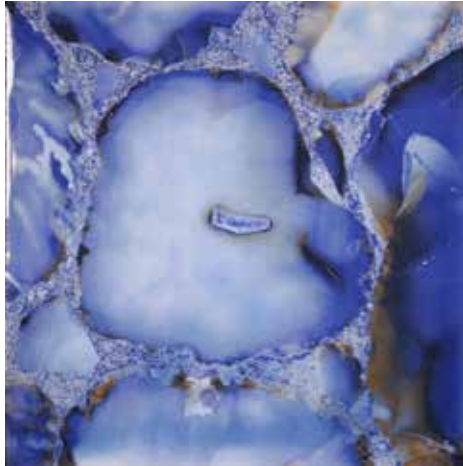



Cobalt

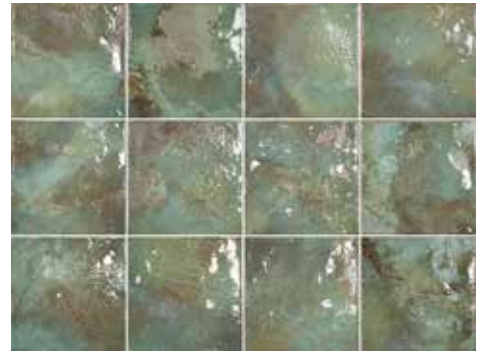
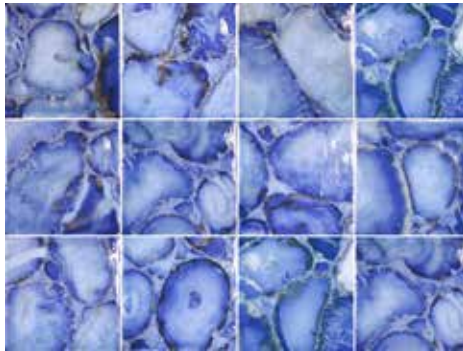
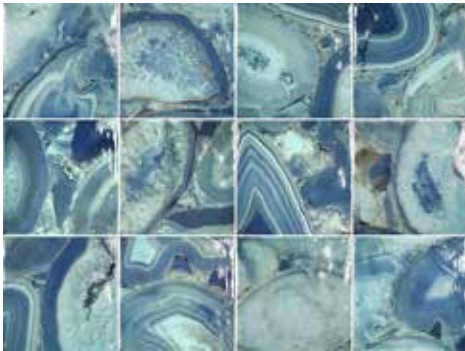

Teal

Variation:



Sizes					
	6" x 6"				
Thickness	9mm				
Grout Joint Recommendation	Check Website				
Testing	Breaking Strength C648	Chemical Resistance C650	Water Absorption C373	Scratch Hardness MOHS	Shade Variation Rating
Results*	>250 lbf	Resistant	<1.0%	4	V3

- Sustainability Attributes**
- Health Product Declaration (HPD) provided upon request
 - Product Packaging is 100% recyclable
 - VOC Free

*For more information visit www.emser.com. Always consult a professional for proper usage and installation.

The many benefits of tile extend to the outdoors with Immerse™ Porcelain tile as a prime example. Designed for walls, in addition to being pool-rated, let your imagination take over with a one-of-a-kind design featuring three splashy colors: Cobalt, Aqua and Teal.

IMMERSE™

Glazed Porcelain





White Ripple



White Bloom

Sizes Thickness Grout Joint Recommendation						
	12" x 24" 11.81" x 23.62"					
	10mm					
1/8"						
Testing	Breaking Strength C648	Chemical Resistance C650	Water Absorption C373	Scratch Hardness MOHS	Shade Variation Rating	
Results*	≤250 lbf	Resistant	>7%	5	V1	

Jazz™ is a glossy, fashion decorative wall tile that should be handled with care during installations. For best results, avoid abrasive materials while handling, installing, or cleaning. Normal cleaning with soapy water or a non-abrasive glass cleaner is recommended.

- Sustainability Attributes**
- Health Product Declaration (HPD) provided upon request
 - Product Packaging is 100% recyclable
 - VOC Free
 - Recycled Content 0% Pre- & Post-Consumer

*For more information visit www.emser.com. Always consult a professional for proper usage and installation.

Jazz™ is an ornamental wall tile with three-dimensional, large-scale designs. Contemporary leaf and ripple-inspired patterns take shape in bright white. Gloss finish allows for specific design statements.

JAZZ™
Glazed Ceramic





Indigo View



Perla Chevron



Perla



Indigo

All Colors Available in Size 16"x47" Gloss Finish | Suitable for Wall Applications Only | Glazed Ceramic
 Indigo & Perla Colors Available in Size 12"x24" Polished and Matte Finish | Suitable for Floor and Wall Applications | Glazed Porcelain

Testing	Breaking Strength	Chemical Resistance	Water Absorption	Scratch Hardness	Shade Variation
	C ₆₄₈	C ₆₅₀	C ₃₇₃	MOHS	Rating
Results*	>350 lbf (12x24) >125 lbf (16x47)	Resistant	<0.5% (12x24) <20% (16x47)	6 (12x24 M) 5 (12x24 P) >3 (16x47)	V4

-  Sustainability Attributes
- Health Product Declaration (HPD) provided upon request
 - Product Packaging is 100% recyclable
 - VOC Free
 - Recycled Content 0% Pre- & Post-Consumer

*For more information visit www.emser.com. Always consult a professional for proper usage and installation.

Kudos™ to this beautiful and durable stone-looking porcelain. The variations and veining in cool grays, blues and greens make each tile unique. The stone-look tile is durable and easy to clean. From floor to wall, for both residential and commercial applications, the possibilities are endless.

KUDOS™

Glazed Ceramic & Porcelain





Opaque



Silver



Gold



Black

Sizes					
	3" x 12" 2.93" x 11.85"				
Thickness	9.5mm				
Grout Joint Recommendation	1/8"				
Testing	Breaking Strength C648	Chemical Resistance C650	Water Absorption C373	Scratch Hardness MOHS	Shade Variation Rating
Results*	>150 lbf	Resistant	<20.0%	4	V4

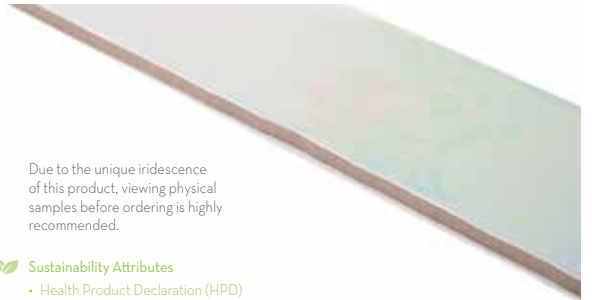

Due to the unique iridescence of this product, viewing physical samples before ordering is highly recommended.

- Sustainability Attributes**
- Health Product Declaration (HPD) provided upon request
 - Product Packaging is 100% recyclable
 - VOC Free

*For more information visit www.emser.com. Always consult a professional for proper usage and installation.

Looking for a signature wow wall moment? Look no further than Luxo™ ceramic tile. Each tile features the beauty of iridescence – think of the subtle shimmer of color seen in a bubble, the fascination with vintage lucite furnishings, even the bold strokes of blues and greens in a rainbow. Creativity at your fingertips with four colorways.

LUXO™
Glazed Ceramic





Blanc



Floret

Sizes					
	16" x 47" 15.57" x 47.17"				
Thickness	11mm				
Grout Joint Recommendation	3/16"				
Testing	Breaking Strength C648	Chemical Resistance C650	Water Absorption C373	Scratch Hardness MOHS	Shade Variation Rating
Results*	>125 lbf	Resistant	<15.0%	Check Website	V2

- Sustainability Attributes**
- Health Product Declaration (HPD) provided upon request
 - Product Packaging is 100% recyclable
 - VOC Free

*For more information visit www.emser.com. Always consult a professional for proper usage and installation.

The designs of Marquesa™ offer a sense of refinement and timeless beauty. The floret pattern instills a regal air while the blanc pattern offers a fresh and modern feel. The large format size and classic marble look make this ceramic tile an ideal choice for any application.

MARQUESA™

Glazed Ceramic





White



Bone



Taupe



Mocha



Sky

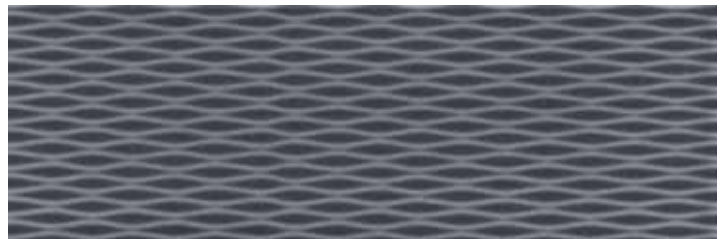

Charcoal

Sizes Thickness Grout Joint Recommendation					
	4" x 12" 3.82" x 11.69"				
	9mm				
3/16"					
Testing	Breaking Strength C648	Chemical Resistance C650	Water Absorption C373	Scratch Hardness MOHS	Shade Variation Rating
Results*	IV	Resistant	<10%	4	V2



- Sustainability Attributes**
- Health Product Declaration (HPD) provided upon request
 - Product Packaging is 100% recyclable
 - VOC Free

*For more information visit www.emser.com. Always consult a professional for proper usage and installation.

Motif II™ rediscovers the ebb and flow of decorative patterns found in visual art. A delicate lace overlay defines this glazed ceramic subway tile collection. With a selection of neutrals, the collection's understated texture and glossy finish combine to create a unique aesthetic.

MOTIF II™

Glazed Ceramic





Princess White

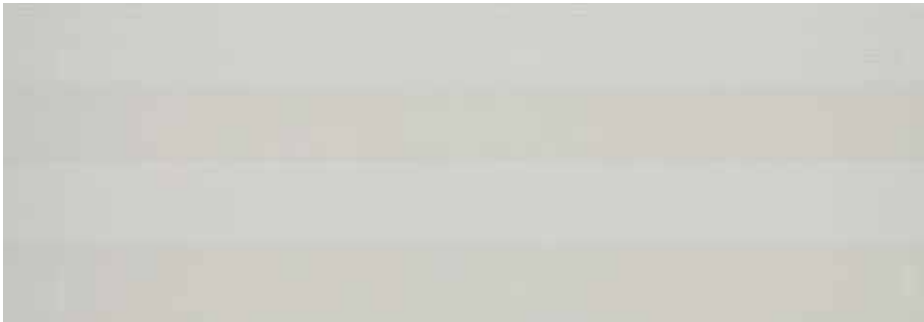

Royal White



Cubic White

Sizes Thickness Grout Joint Recommendation																	
	12" x 35" 11.61" x 35.43"																
	10.6mm																
<table border="1"> <thead> <tr> <th>Testing</th> <th>Breaking Strength C648</th> <th>Chemical Resistance C650</th> <th>Water Absorption C373</th> <th>Scratch Hardness MOHS</th> <th>Shade Variation Rating</th> </tr> </thead> <tbody> <tr> <td>Results*</td> <td>≤250 lbf</td> <td>Resistant</td> <td>>7%</td> <td>5</td> <td>V1</td> </tr> </tbody> </table>						Testing	Breaking Strength C648	Chemical Resistance C650	Water Absorption C373	Scratch Hardness MOHS	Shade Variation Rating	Results*	≤250 lbf	Resistant	>7%	5	V1
Testing	Breaking Strength C648	Chemical Resistance C650	Water Absorption C373	Scratch Hardness MOHS	Shade Variation Rating												
Results*	≤250 lbf	Resistant	>7%	5	V1												

- Sustainability Attributes**
- Health Product Declaration (HPD) provided upon request
 - Product Packaging is 100% recyclable
 - VOC Free
 - Recycled Content 0% Pre- & Post-Consumer

*For more information visit www.emser.com. Always consult a professional for proper usage and installation.

Nuovo™ illustrates undeniable glamour and sophistication through form and texture in a glazed ceramic wall tile. Distinct large-scale geometry is amplified with small-scale etched details to refract light and complement other textures. Three patterns add dimensionality to luxurious design statements or subtle backdrops.

NUOVO™
Glazed Ceramic





White



Ivory



Taupe



Silver



Blue

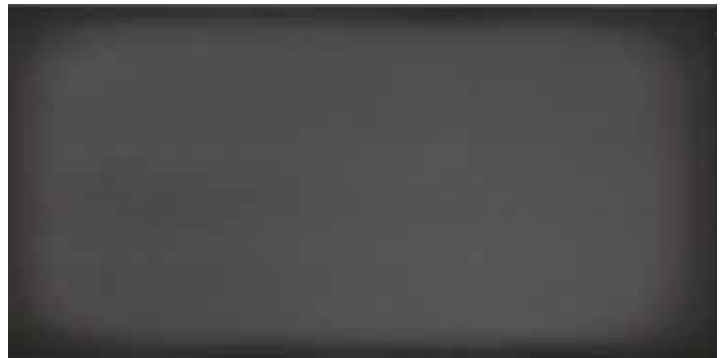

Graphite

Sizes					
	6" x 12" 6" x 12"	4" x 12" Wall SBN			
Thickness	9mm				
Grout Joint Recommendation	1/8"				
Testing	Breaking Strength C648	Chemical Resistance C650	Water Absorption C373	Scratch Hardness MOHS	Shade Variation Rating
Results*	<250 lbf	Resistant	>7%	4	V2

- Sustainability Attributes**
- Health Product Declaration (HPD) provided upon request
 - Product Packaging is 100% recyclable
 - VOC Free
 - Recycled Content 0% Pre- & Post-Consumer

*For more information visit www.emser.com. Always consult a professional for proper usage and installation.

An avant-garde expression of a classic subway tile, Ombre™ is a glazed ceramic wall tile that creates a luminous effect fading from a bright center to a darker, saturated edge.

OMBRE™

Glazed Ceramic

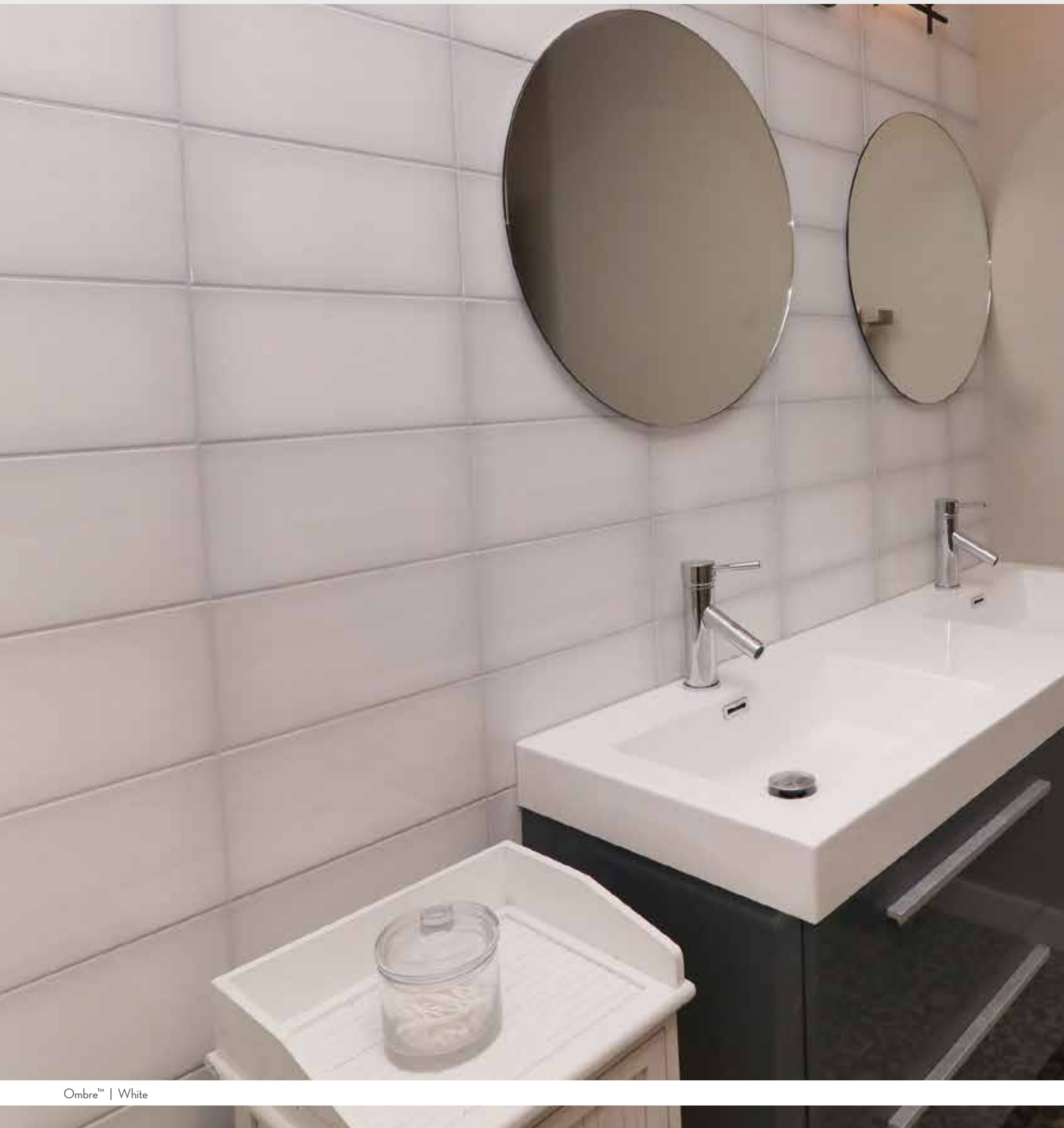

FLOOR / WALL  RESIDENTIAL  COMMERCIAL  INDOOR 



Blanco



Crema



Rosa



Gris



Azul



Verde





Nero

The coloration of Passion™ is anything but ordinary. Rated as a V4, this line provides a dramatic variation in color and shade making each installation truly unique.

Color Variation:



Sizes					
	3" x 8" 2.56" x 7.87"	9" x 9" Glossy & Matte	1/2" x 8" Jolly		
	Thickness	10mm	Check Website	13mm	
Grout Joint Recommendation	1/8" Check Website				
Testing	Breaking Strength C648	Chemical Resistance C650	Water Absorption C373	Scratch Hardness MOHS	Shade Variation Rating
Results*	>225 lbf (3x8) TIP (9x9)	Resistant (3x8) TIP (9x9)	<1.0% (3x8) TIP (9x9)	7 (3x8) TIP (9x9)	V4 (3x8) TIP (9x9)

-  Sustainability Attributes
- Health Product Declaration (HPD) provided upon request
 - Product Packaging is 100% recyclable
 - VOC Free

*For more information visit www.emser.com. Always consult a professional for proper usage and installation.

The striking colors of Passion™ will inspire breathtaking designs throughout any living space. This unique wall tile transcends traditional subway tiles into something ethereal. Colors ranging from soft White to delicate Rosa to deep Nero, Passion™ brings a truly magical element that will complement any decor.

PASSION™

Glazed Porcelain





White



Metallic

Sizes Thickness Grout Joint Recommendation					
	2" x 10" 1.97" x 9.84"				
	10mm				
3/16"					
Testing	Breaking Strength C648	Chemical Resistance C650	Water Absorption C373	Scratch Hardness MOHS	Shade Variation Rating
Results*	≥250 lbf	Resistant	≤5.0%	6	V1

- Sustainability Attributes**
- Health Product Declaration (HPD) provided upon request
 - Product Packaging is 100% recyclable
 - VOC Free

*For more information visit www.emser.com. Always consult a professional for proper usage and installation.

Place2B™ is a brick-shaped tile offered in both matte and metallic finishes. Its classic shape and texture allow for the creation of unlimited design solutions.

PLACE2B™

Glazed Ceramic





White



Silver



Ocean



Blue



Charcoal



Mustard



Olive



Ruby

The coloration of Raku™ is anything but ordinary. Rated as a V4, this line provides a dramatic variation in color and shade making each installation truly unique.

Color Variation:



Sizes					
	3" x 12" 2.95" x 11.81"		1/2" x 12" Jolly		
Thickness	10mm		13mm		
Grout Joint Recommendation	1/8"				
Testing	Breaking Strength C648	Chemical Resistance C650	Water Absorption C373	Scratch Hardness MOHS	Shade Variation Rating
Results*	>125 lbf	Resistant	>10.0%	4	V4

Raku is available in matte and gloss finishes.

- Sustainability Attributes**
- Health Product Declaration (HPD) provided upon request
 - Product Packaging is 100% recyclable
 - VOC Free

*For more information visit www.emser.com. Always consult a professional for proper usage and installation.

Inspired by the Japanese method for firing pottery, Raku™ brings to life this ancient method in a contemporary form. The unique look of Raku™ provides endless design options. The eight tranquil colors evoke happiness and are ideal for any application.

RAKU™
Glazed Ceramic



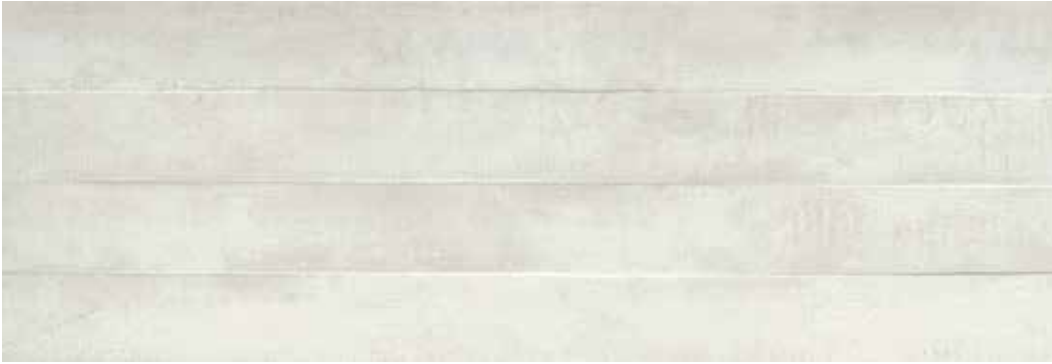

White



Gray



Buff

Sizes Thickness Grout Joint Recommendation						
	16" x 47" 15.67" x 46.85"					
	11mm					
Testing		Breaking Strength C648	Chemical Resistance C650	Water Absorption C373	Scratch Hardness MOHS	Shade Variation Rating
Results*		>125 lbf	Resistant	<15.0%	Check Website	V1

- Sustainability Attributes**
- Health Product Declaration (HPD) provided upon request
 - Product Packaging is 100% recyclable
 - VOC Free
 - Recycled Content 39% Pre-Consumer

*For more information visit www.emser.com. Always consult a professional for proper usage and installation.

Rift™ offers a natural stone look in a plank size. The unique linear design in each tile provides dimension and character making this a stand out in any setting. The subtle coloring and shading throughout the tiles makes Rift™ a timeless classic.

RIFT™

Glazed Ceramic



FLOOR / WALL  RESIDENTIAL  COMMERCIAL  INDOOR 



Flat White



Wave White



Chevron White



Flat Venato



Wave Venato



Chevron Venato



Flat Oro





Wave Oro



Chevron Oro

Flat, Wave, and Chevron Colors Available in Size 13"x36" Gloss Finish | Suitable for Wall Applications Only
 All Flat Colors Available in 12"x24" Matte Finish | Suitable for Floor, Wall, and Outdoor Applications

Sizes					
	13"x36" Wall <small>12.99" x 35.83"</small>	12"x24" Floor <small>12.01" x 24.21"</small>	3"x12" Floor SBN		
	Thickness	10.5mm	10mm	9.5mm	
Grout Joint Recommendation	1/16"	3/16"			
Testing	Breaking Strength C648	Chemical Resistance C650	Water Absorption C373	Scratch Hardness MOHS	Shade Variation Rating
Results*	Floor: ≥500 lbf Wall: ≥300 lbf	Floor: Resistant Wall: Non-Resistant	Floor: <0.50% Wall: > 0.7%	Floor: 6 Wall: 5	V2

-  Sustainability Attributes
- Health Product Declaration (HPD) provided upon request
 - Product Packaging is 100% recyclable
 - VOC Free
 - Recycled Content 0% Pre- & Post-Consumer

*For more information visit www.emser.com. Always consult a professional for proper usage and installation.

Sculpture™ is inspired by the artistic beauty of white Italian marble. Sculpture™ is available in a flat matte finish, perfect for floors, along with a gloss finish to coordinate for walls.

SCULPTURE™

Glazed Ceramic & Porcelain





White

Sizes Thickness Grout Joint Recommendation						
	16" x 47" 15.67" x 47.17"					
	11mm					
1/16"						
Testing	Breaking Strength C648	Chemical Resistance C650	Water Absorption C373	Scratch Hardness MOHS	Shade Variation Rating	
Results*	Check Website	Check Website	Check Website	Check Website	V1	

- Sustainability Attributes**
- Health Product Declaration (HPD) provided upon request
 - Product Packaging is 100% recyclable
 - VOC Free

*For more information visit www.emser.com. Always consult a professional for proper usage and installation.

Fashioned after its musical name, Sonata™ is a large format tile that embodies delicately balanced movement through its design. Featuring a subtle raised element that adds dimension and texture. Sonata's elegant pattern flow provides interest and intrigue to any environment.

SONATA™

Glazed Ceramic





Plain



Linear



Woven



Square



Chevron

Sizes					
	12" x 39" 12.40" x 39.57"				
Thickness	9.5mm				
Grout Joint Recommendation	1/16"				
Testing	Breaking Strength C648	Chemical Resistance C650	Water Absorption C373	Scratch Hardness MOHS	Shade Variation Rating
Results*	Check Website	Check Website	Check Website	Check Website	V1

- Sustainability Attributes**
- Health Product Declaration (HPD) provided upon request
 - Product Packaging is 100% recyclable
 - VOC Free
 - Recycled Content 39% Pre-Consumer

*For more information visit www.emser.com. Always consult a professional for proper usage and installation.

Sparkle™ is a vivacious large format tile that provides a range of texture to enliven any space. The five contemporary patterns are versatile and work beautifully with any design theme. This tile will make quite a statement.

SPARKLE™

Glazed Ceramic





White



Ivory



Fawn



Mint



Taupe

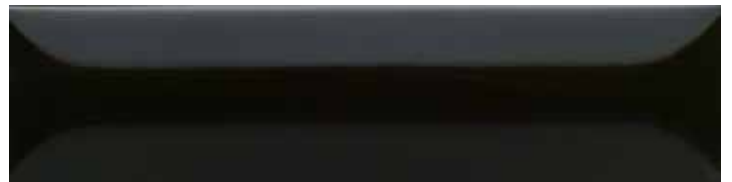

Black

<p>Sizes</p> <p>Thickness</p> <p>Grout Joint Recommendation</p>						
	<p>3" x 12" 2.95" x 11.81"</p>					
	<p>9mm</p>					
<p>3/16"</p>						
Testing	<p>Breaking Strength C648</p>	<p>Chemical Resistance C650</p>	<p>Water Absorption C373</p>	<p>Scratch Hardness MOHS</p>	<p>Shade Variation Rating</p>	
Results*	>250 lbf	Resistant	<20.0%	5	V2	

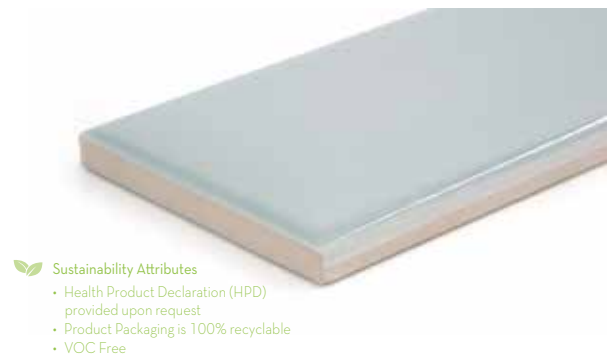

- Sustainability Attributes**
- Health Product Declaration (HPD) provided upon request
 - Product Packaging is 100% recyclable
 - VOC Free

*For more information visit www.emser.com. Always consult a professional for proper usage and installation.

The symmetrical nature of Sphere™ provides a three dimensional look that transcends classic subway tiles. The neutral color palette makes for a comforting environment. The standard size and complementary colorways offer an opportunity to mix-and-match for a truly unique look.

SPHERE™

Glazed Ceramic







Chevron White

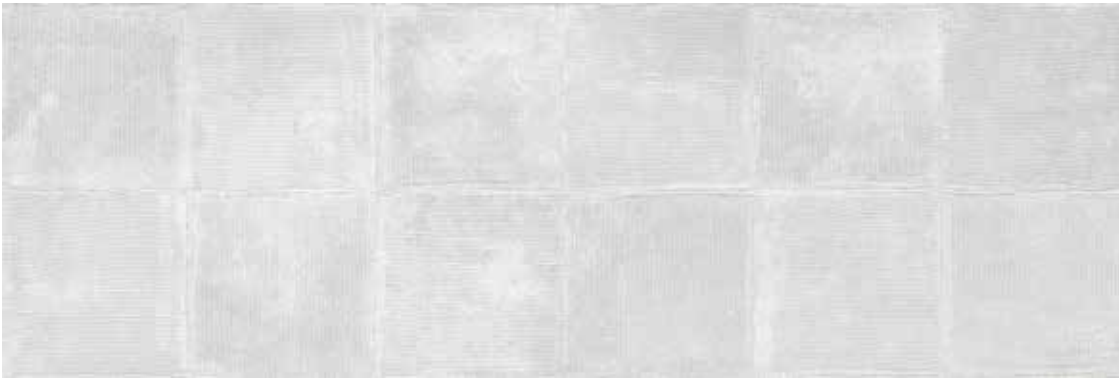

Plaster Gray



Plaster White

Sizes Thickness Grout Joint Recommendation						
	16" x 47" <small>15.67" x 47.16"</small>					
	10.9mm					
Testing		Breaking Strength <small>C648</small>	Chemical Resistance <small>C650</small>	Water Absorption <small>C373</small>	Scratch Hardness <small>MOHS</small>	Shade Variation Rating
Results*		>225 lbf	Resistant	<18.0%	Check Website	Chevron: V1 Plaster: V2

- Sustainability Attributes**
- Health Product Declaration (HPD) provided upon request
 - Product Packaging is 100% recyclable
 - VOC Free

*For more information visit www.emser.com. Always consult a professional for proper usage and installation.

Synergy™ combines texture with a hint of luminescence. This large format glazed ceramic tile provides a three dimensional effect with a contemporary and clean plaster look to a subtly shimmering chevron pattern. Synergy has a look for any application.

SYNERGY™

Glazed Ceramic





Plain White



Chevron White



Linear White

Sizes					
	10" x 30" 9,84" x 29,53"				
Thickness	8mm				
Grout Joint Recommendation	3/16"				
Testing	Breaking Strength C648	Chemical Resistance C650	Water Absorption C373	Scratch Hardness MOHS	Shade Variation Rating
Results*	≤250 lbf	Non-Resistant	≤5%	5	V1

- Sustainability Attributes**
- Health Product Declaration (HPD) provided upon request
 - Product Packaging is 100% recyclable
 - VOC Free
 - Recycled Content 0% Pre- & Post-Consumer

*For more information visit www.emser.com. Always consult a professional for proper usage and installation.

The sleek patterns and soft white of Vertigo™ coordinate to create a contemporary look. Patterns include plain, linear and chevron. Its unique size and glossy appearance give Vertigo™ a sophisticated and modern edge.

VERTIGO™

Glazed Ceramic





Kinetic™ • Gray 11" x 12"

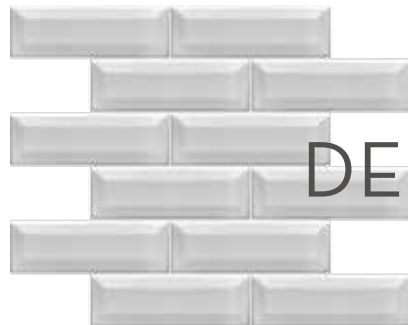

DECORATIVE

WALL  RESIDENTIAL  COMMERCIAL  INDOOR  OUTDOOR  POOL 



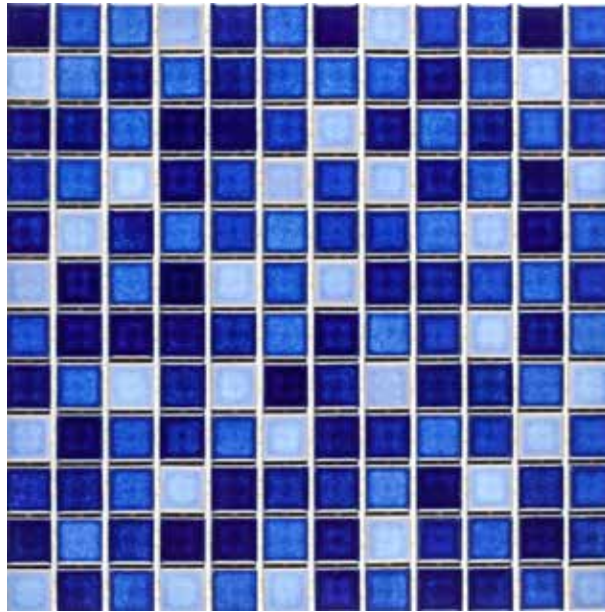

Aqua



Cobalt



Teal

Sizes			
	12" x 12" Dot Mount	12" x 13" Dot Mount	12" x 12" Dot Mount
Thickness	6mm	6mm	6mm
Testing	Shade Variation Rating		
Results*	V3		

-  Sustainability Attributes
- Health Product Declaration (HPD) provided upon request
 - Product Packaging is 100% recyclable
 - VOC Free

*For more information visit www.emser.com. Always consult a professional for proper usage and installation.

Transform your pool into a personal oasis. With hues as vibrant as coveted sea glass finds, Afloat™ porcelain tile is especially meant for those who embrace pool living. Make a jewel-toned splash with this unique design.

AFLOAT™
Glazed Porcelain Mosaic



FLOOR / WALL  RESIDENTIAL  COMMERCIAL  INDOOR 



Mini Castle Cream

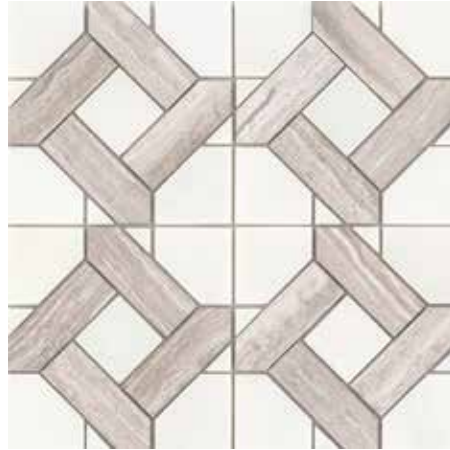

Mini Manor Cream



Mini Palace Cream



Mini Castle Silver



Mini Manor Silver



Mini Palace Silver



Castle Cream



Manor Cream



Palace Cream





Castle Silver



Manor Silver



Palace Silver

Sizes		
	12" x 12" 12" x 12"	9" x 9" 9.02" x 9.02"
Thickness	10mm	
Testing	Shade Variation Rating	
Results*	V2	

-  Sustainability Attributes
- Health Product Declaration (HPD) provided upon request
 - Product Packaging is 100% recyclable
 - VOC Free

*For more information visit www.emser.com. Always consult a professional for proper usage and installation.

Alluro™ is a modern re-creation of parquet style design, using a variety of unique and eye-catching marble mosaics. Available in varying shades of silver and cream, Alluro is a fresh take on a traditional marble look. Available in 9"x9" and 12"x12" sizes

ALLURO™

Marble Mosaic



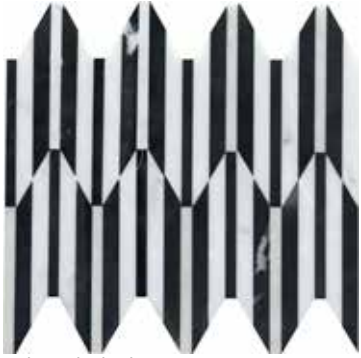

White / Black



White / Cream

All Peak Colors Available in Size 10"x12"
Not pictured White/Gray and White/White



White / Gray

All Damask Colors Available in Size 9"x13"
Not pictured White/Cream, White/White, and White/Black



White / White







White / Cream

All Chevron Colors Available in Size 12"x13"
Not pictured Cream/Taupe and Black/White



Black / White

All Crest Colors Available in Size 13"x13"
Not pictured White/Cream, White/Taupe, and White/Black

Sizes				
	12"x13"	13"x13"	9"x13"	10"x12"
Thickness	8mm	8mm	8mm	8mm
Testing	Shade Variation Rating			
Results*	Check Website			

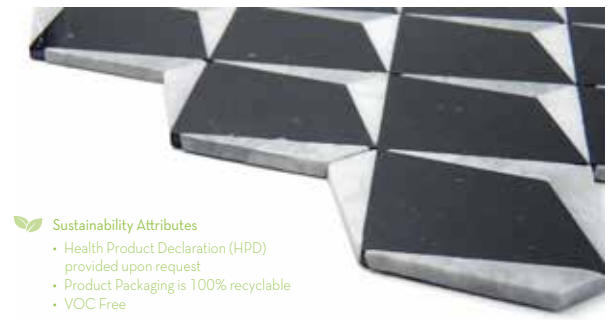

- Sustainability Attributes**
- Health Product Declaration (HPD) provided upon request
 - Product Packaging is 100% recyclable
 - VOC Free

*For more information visit www.emser.com. Always consult a professional for proper usage and installation.

Bizou™ marble, grout-less mosaic takes inspiration from iconic motifs in architecture and fashion – chevron, crest, damask and peak. The use of marble brings an ornamental and classic visual to kitchens, baths and other rooms. The four patterns in striking and contrasting neutrals make an elegant statement.

BIZOU™

Groutless Marble Mosaic



FLOOR / WALL  RESIDENTIAL  COMMERCIAL  INDOOR 

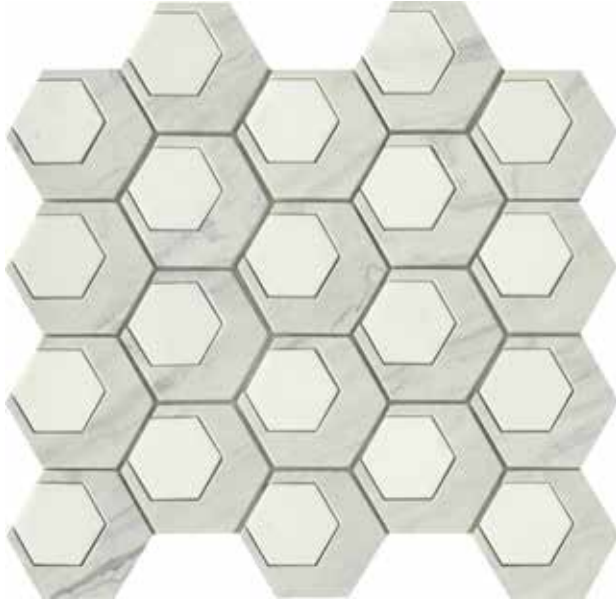

Hydrogen



Pluto



Oxygen



Saturn

<p>Sizes</p>	 <p>13" x 14" 12.59" x 13.62"</p>
<p>Thickness</p>	<p>8mm</p>
<p>Testing</p>	<p>Shade Variation Rating</p>
<p>Results*</p>	<p>V2</p>

-  Sustainability Attributes
- Health Product Declaration (HPD) provided upon request
 - Product Packaging is 100% recyclable
 - VOC Free

*For more information visit www.emser.com. Always consult a professional for proper usage and installation.

With an interesting mix of materials, Catalyst™ creates an exclusive collection of surface effects. This line presents an array of options using hexagon shaped mosaics and combinations of textures made of glass, cast stone and natural stone.

CATALYST™

Resin Cast Stone & Glass Mosaic





Wise



Poise



Delight



Finesse



Grace



Finesse



Poise





Delight



Wise

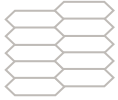
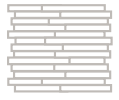

Grace

Sizes			
	10" x 12" 10.24" x 11.81"	11" x 12" 10.71" x 11.81"	10" x 13" 9.76" x 12.60"
Thickness	4mm	4mm	4mm
Testing	Shade Variation Rating		
Results*	VI		

-  Sustainability Attributes
- Health Product Declaration (HPD) provided upon request
 - Product Packaging is 100% recyclable
 - VOC Free

*For more information visit www.emser.com. Always consult a professional for proper usage and installation.

Charisma™ captures the modern mosaic with picket, linear, and herringbone motifs. A wide array of soft tones alternate in varying degrees for lively visual appeal. The contemporary glass mosaic series is a blend of gloss and matte finish.

CHARISMA™

Glass Mosaic



Charisma™ | Grace Herringbone



Finesse



Delight



Wise



Grace



Fawn 2" Hex

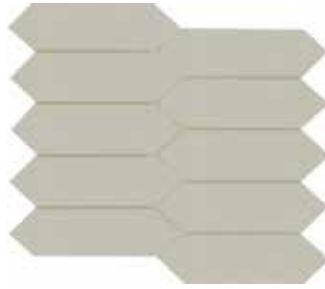

Fawn Picket



Fawn Cube



Fawn Chevron

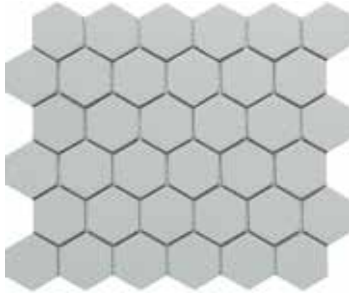

Gray 2" Hex

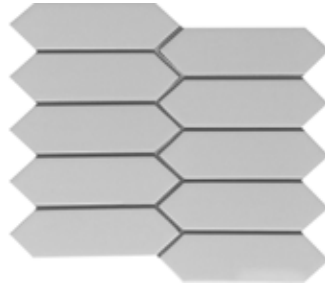

Gray Picket

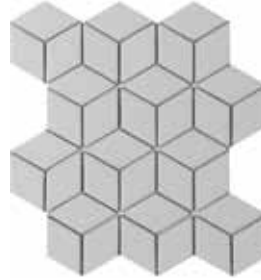

Gray Cube

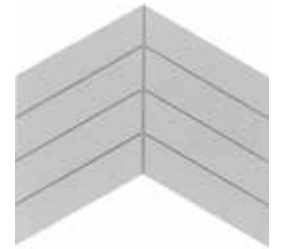

Gray Chevron



White 2" Hex





White Picket



White Cube

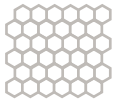
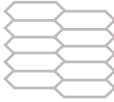

White Chevron

Sizes				
	11" x 12" Mesh 10.62" x 12.4"	8" x 10" Mesh 8.34" x 12.4"	10" x 12" Mesh 10.24" x 11.81"	8" x 12" Mesh 8.34" x 12.4"
Thickness	6mm	6mm	6mm	6mm
Testing	Shade Variation Rating			
Results*	VI			

-  Sustainability Attributes
- Health Product Declaration (HPD) provided upon request
 - Product Packaging is 100% recyclable
 - VOC Free

*For more information visit www.emser.com. Always consult a professional for proper usage and installation.

Concept™ is a glazed glass mosaic that resembles porcelain tile. The modern shapes and neutral tones offer striking designs for walls. This series is available in a glossy finish for added interest.

CONCEPT™

Glazed Glass Mosaic



FLOOR / WALL  RESIDENTIAL  COMMERCIAL  INDOOR  OUTDOOR 



Hexagon Freddo Blend



Hexagon White



Hexagon Metal Blend



Hexagon Bronze

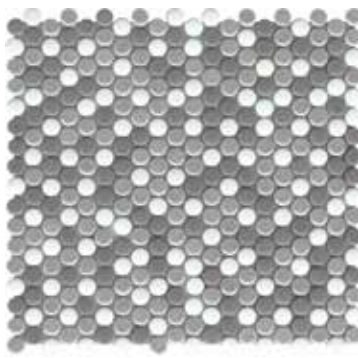

Penny Freddo Blend



Penny White

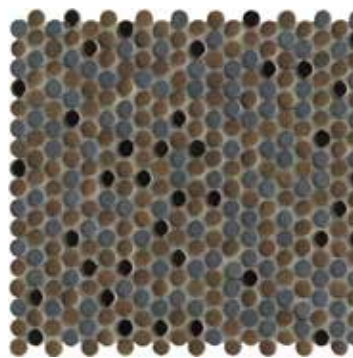

Penny Metal Blend

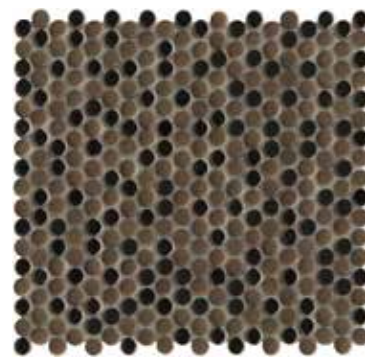

Penny Bronze

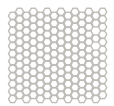
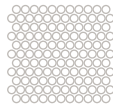
Sizes		
	12" x 12" Mesh 11.81" x 11.81"	12" x 12" Mesh 11.81" x 11.81"
Thickness	8mm	8mm
Testing	Shade Variation Rating	
Results*	V2	

Bronze and Metal Colors Not Suitable for Floor Application

-  Sustainability Attributes
- Health Product Declaration (HPD) provided upon request
 - Product Packaging is 100% recyclable
 - VOC Free

*For more information visit www.emser.com. Always consult a professional for proper usage and installation.

Confetti II™ offers solid and multicolor blends in penny round and hexagon mosaics. This series can be used on its own to make a statement or as a decorative accent.

CONFETTI II™

Recycled Glass & Porcelain Mix Mosaic



FLOOR / WALL 

RESIDENTIAL 

COMMERCIAL 

INDOOR 

OUTDOOR 

POOL 



Winter



Summer



Autumn



Spring



Black



White



Ivory



Cream



Beige



Gray



Silver



Taupe

<p>Sizes</p>	 <p>12" x 12" Mesh 11.81" x 11.81"</p>
<p>Thickness</p>	<p>4mm</p>
<p>Testing</p>	<p>Shade Variation Rating</p>
<p>Results*</p>	<p>V2</p>



-  Sustainability Attributes
- Health Product Declaration (HPD) provided upon request
 - Product Packaging is 100% recyclable
 - VOC Free

*For more information visit www.emser.com. Always consult a professional for proper usage and installation.

Cultura™ is comprised of first-rate natural stone that is fabricated into an intriguing pebble configuration. An array of solid colors and blends are available in a subtly honed finish on an interlocking mesh.

CULTURA™

Pebbles Mosaic



Cultura™ | Summer



Cultura™ | Winter



Ares



Athena



Chronos

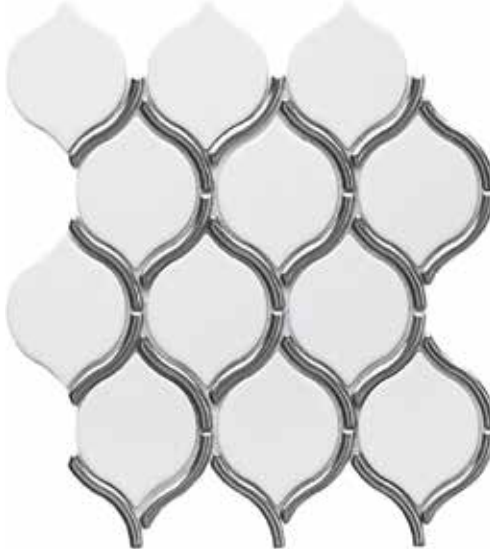

Poseidon

<p>Sizes</p>	 <p>10" x 12" Mesh 10.28" x 11.49"</p>
<p>Thickness</p>	<p>8mm</p>
<p>Testing</p>	<p>Shade Variation Rating</p>
<p>Results*</p>	<p>V2</p>

- Sustainability Attributes**
- Health Product Declaration (HPD) provided upon request
 - Product Packaging is 100% recyclable
 - VOC Free

*For more information visit www.emser.com. Always consult a professional for proper usage and installation.

Intricate geometrics inspired by retro patterns find new form in Diva™. Bold motifs feature a splash of metallic bling for a true statement in decorative mosaic design. Four available colors offer a multi-dimensional focal point for your next project.

DIVA™
Glazed Ceramic Mosaic



FLOOR / WALL  RESIDENTIAL  COMMERCIAL  INDOOR  OUTDOOR 



White Herringbone



Gray Herringbone



Brown Herringbone



White 2" Hex



Gray 2" Hex





Brown 2" Hex



White 3" Hex



Calcata 3" Hex

Sizes			
	11" x 13" Mesh 11.10" x 12.83"	12" x 14" Mesh 11.81" x 13.57"	10" x 12" Mesh 10.16" x 11.81"
Thickness	6mm	6mm	6mm
Testing	Shade Variation Rating		
Results*	V2		



-  Sustainability Attributes
- Health Product Declaration (HPD) provided upon request
 - Product Packaging is 100% recyclable
 - VOC Free

*For more information visit www.emser.com. Always consult a professional for proper usage and installation. Not suitable for outdoor floor.

Echo™ portrays a dynamic union of shape, pattern, and sustainability. Hexagon and herringbone mosaic tiles are crafted entirely of recycled white, gray, and brown glass. Finished with high-definition inkjets of wood grain and Calacatta marble patterns, the glass mosaic series is ideal for kitchen and bath surfaces.

ECHO™
Recycled Glass Mosaic





White



Gray



Morning Fog



Navy

Sizes	 12" x 12" Mesh 11.97" x 12.13"
Thickness	8mm
Testing	Shade Variation Rating
Results*	V2

-  Sustainability Attributes
- Health Product Declaration (HPD) provided upon request
 - Product Packaging is 100% recyclable
 - VOC Free

*For more information visit www.emser.com. Always consult a professional for proper usage and installation.

Edge™ features frosted glass to illustrate a story of shape and color. Neutral overtones and saturated accent colors take form in a design-forward chevron mosaic.

EDGE™

Glass Mosaic



WALL  RESIDENTIAL  COMMERCIAL  INDOOR 



Energy



Gusto



Life



Spirit

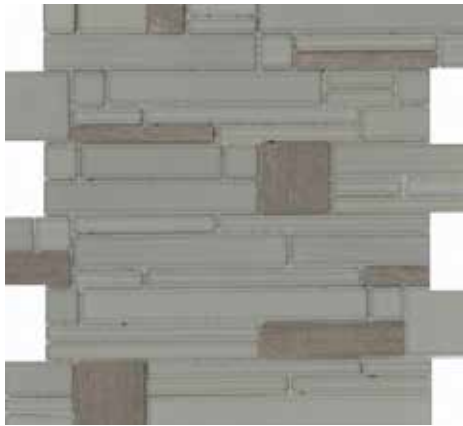

Vigor

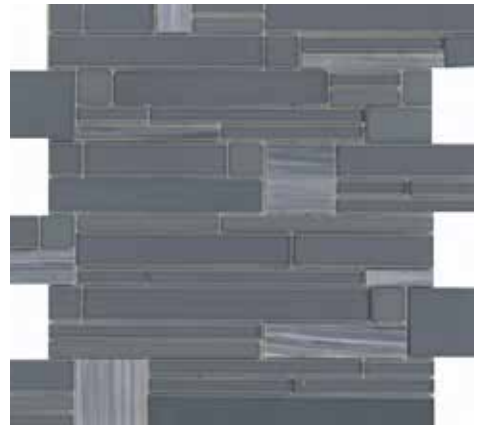

Zest

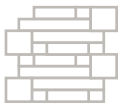
<p>Sizes</p>  <p>12" x 12" Mesh 11.81" x 11.81"</p>	
<p>Thickness</p>	<p>8mm</p>
<p>Testing</p>	<p>Shade Variation Rating</p>
<p>Results*</p>	<p>V2</p>

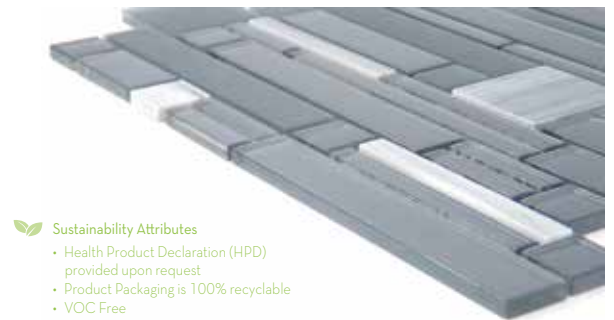

-  Sustainability Attributes
- Health Product Declaration (HPD) provided upon request
 - Product Packaging is 100% recyclable
 - VOC Free

*For more information visit www.emser.com. Always consult a professional for proper usage and installation.

Entity™ is a stylish combination of glass and stone creating stunning mosaics. This look is achieved with intriguing color options and a unique design.

ENTITY™

Glass & Stone Mosaic





White



Multi



Silver

<p>Sizes</p>	 <p>12" x 18" 12.01" x 17.99"</p>
<p>Thickness</p>	<p>6mm</p>
<p>Testing</p>	<p>Shade Variation Rating</p>
<p>Results*</p>	<p>V2</p>

- Sustainability Attributes**
- Health Product Declaration (HPD) provided upon request
 - Product Packaging is 100% recyclable
 - VOC Free

*For more information visit www.emser.com. Always consult a professional for proper usage and installation.

Feature™ is a groutless stone mosaic that is easy to install and turns an ordinary wall into a showpiece. The unique texture, color and three dimensional look of Feature™ provides depth and warmth to any installation.

FEATURE™

Groutless Stone Mosaic



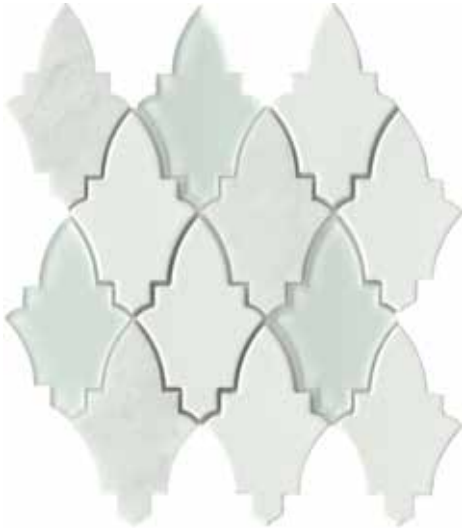

Affodill



Orchis



Pivone



Roza

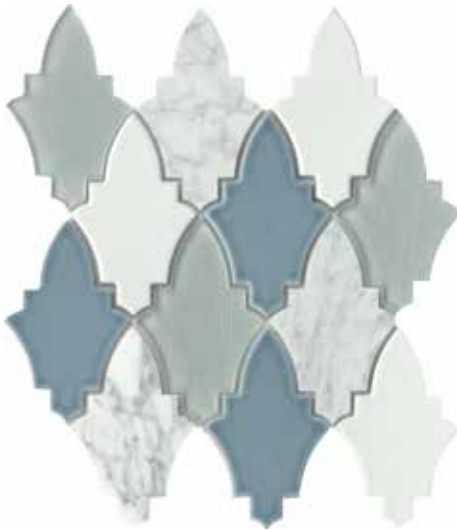

Viole

<p>Sizes</p>	 <p>11"x12" Mesh 11.38"x12.01"</p>
<p>Thickness</p>	<p>8mm</p>
<p>Testing</p>	<p>Shade Variation Rating</p>
<p>Results*</p>	<p>V3</p>

-  Sustainability Attributes
- Health Product Declaration (HPD) provided upon request
 - Product Packaging is 100% recyclable
 - VOC Free

*For more information visit www.emser.com. Always consult a professional for proper usage and installation.



The french word for flower, Fleur™ is a stately, mixed-material mosaic that combines stone, ceramic and glass for an elegant and dimensional wall feature.

FLEUR™

Glazed Ceramic, Stone & Glass Mosaic



WALL  RESIDENTIAL  COMMERCIAL  INDOOR 



Fame



Glory



Joy



Love



Value

<p>Sizes</p>	 <p>12" x 12" Mesh 11.81" x 11.97"</p>
<p>Thickness</p>	<p>6mm</p>
<p>Testing</p>	<p>Shade Variation Rating</p>
<p>Results*</p>	<p>VI</p>



-  Sustainability Attributes
- Health Product Declaration (HPD) provided upon request
 - Product Packaging is 100% recyclable
 - VOC Free

*For more information visit www.emser.com. Always consult a professional for proper usage and installation.

Glitz™ is a collection of shimmering mosaics that evoke a captivating aesthetic with brush-like movement. Metallic accents and layered texture take form in hexagon shapes. With an array of eye-catching color variations, Glitz™ enables endless design opportunities.

GLITZ™

Glass & Metal Mosaic





White



Ivory



Silver



Fawn



Sterling



Turquoise



Forest

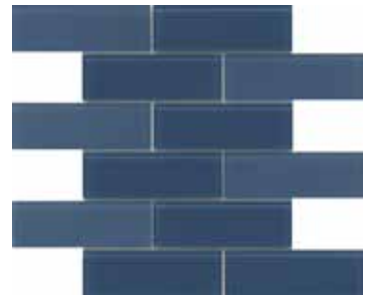

Navy



Powder

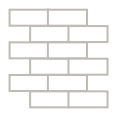

Dove

<p>Sizes</p>	 <p>12" x 12" Mesh 11.89" x 12.25"</p>
<p>Thickness</p>	<p>5mm Dove, Powder, White: 6mm</p>
<p>Testing</p>	<p>Shade Variation Rating</p>
<p>Results*</p>	<p>V4</p>

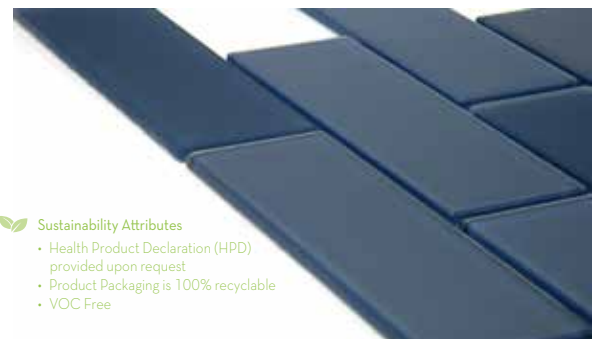

- Sustainability Attributes**
- Health Product Declaration (HPD) provided upon request
 - Product Packaging is 100% recyclable
 - VOC Free

*For more information visit www.emser.com. Always consult a professional for proper usage and installation.

Inspired by the rich colors found in deep water, H2O™ is a fresh take on subway tiles in a clean, modern mosaic.

H2O™
Glass Mosaic



WALL  RESIDENTIAL  COMMERCIAL  INDOOR  OUTDOOR 



Fawn



Gray



Olive

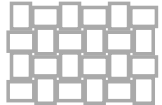

White

<p>Sizes</p>	 <p>9" x 13" 8.94" x 13.46"</p>
<p>Thickness</p>	<p>7mm</p>
<p>Testing</p>	<p>Shade Variation Rating</p>
<p>Results*</p>	<p>V2</p>

-  Sustainability Attributes
- Health Product Declaration (HPD) provided upon request
 - Product Packaging is 100% recyclable
 - VOC Free

*For more information visit www.emser.com. Always consult a professional for proper usage and installation.



The term Hanami™ (Japanese for “flower viewing”) describes the famous tradition of the cherry blossom festival. The glazed porcelain stoneware is a curated collection of architectural ceramics inspired from Japan. Each color exudes a gentle lightness thanks to their pure, simple, and carefree tones.

HANAMI™

Glazed Porcelain Mosaic





Flare



Luster



Halo

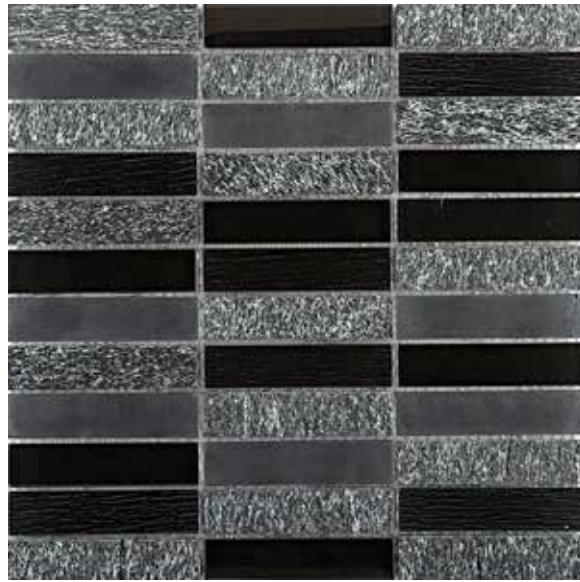

Shimmer

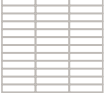
Sizes  12" x 12" Mesh 11.73" x 11.73"	Thickness 8mm
	Testing Shade Variation Rating
Results* VI	

-  Sustainability Attributes
- Health Product Declaration (HPD) provided upon request
 - Product Packaging is 100% recyclable
 - VOC Free

*For more information visit www.emser.com. Always consult a professional for proper usage and installation.

The Illumina™ series plays with texture, merging the natural beauty of stone and glass in a modern mosaic setting.

ILLUMINA™

Glass & Stone Mosaic





Gray Herringbone



Gray Hexagon

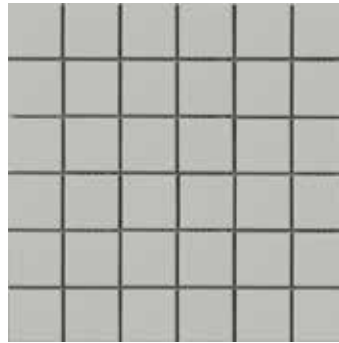

Gray 2"x2"



Gray 1"x3" Stacked



White Herringbone



White Hexagon

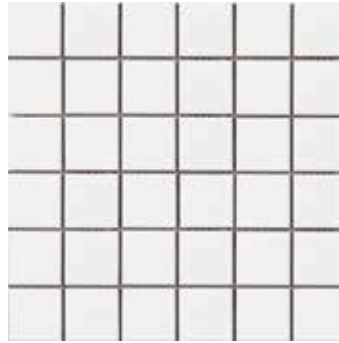

White 2"x2"



White 1"x3" Stacked

Sizes				
	11"x12" Mesh 10.90" x12.44"	11"x13" Mesh 11.10" x12.79"	12"x12" Mesh 12.04" x12.04"	12"x11" Mesh 11.61" x11.46"
Thickness	5.5mm	5.5mm	5.5mm	5.5mm
Testing	Shade Variation Rating			
Results*	VI			

- Sustainability Attributes
- Health Product Declaration (HPD) provided upon request
 - Product Packaging is 100% recyclable
 - VOC Free

*For more information visit www.emser.com. Always consult a professional for proper usage and installation.

The clean and bright look of Impact™ makes a statement in any room. Timeless patterns such as Hex and Herringbone complement both modern and traditional design aesthetics. This matte tile offers a more subdued look.

IMPACT™
Glazed Porcelain Mosaic





Blue Chevron | Limestone & Glass



Cream Chevron | Limestone & Glass



White Chevron | Marble & Glass



Winter Chevron | Marble & Glass

Sizes	
	14" x 15" 13.98" x 15.16"
Thickness	8mm
Testing	Shade Variation Rating
Results*	V2

-  Sustainability Attributes
- Health Product Declaration (HPD) provided upon request
 - Product Packaging is 100% recyclable
 - VOC Free

*For more information visit www.emser.com. Always consult a professional for proper usage and installation.

Chevron patterns continue to bring a contemporary viewpoint to interiors. The result: a simple and seamless installation for a striking look that is both modern and cool. Available in four colorways: Cream, Blue, Winter, and White.

IMPULSE™

*Marble, Limestone & Antique
Mirrored Glass Mosaic*



WALL  RESIDENTIAL  COMMERCIAL  INDOOR 



White



Beige



Natural



Aeon



Era

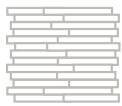

Time

<p>Sizes</p>	 <p>12" x 12" Mesh 11.73" x 11.73"</p>
<p>Thickness</p>	<p>4mm</p>
<p>Testing</p>	<p>Shade Variation Rating</p>
<p>Results*</p>	<p>V3</p>

-  Sustainability Attributes
- Health Product Declaration (HPD) provided upon request
 - Product Packaging is 100% recyclable
 - VOC Free

*For more information visit www.emser.com. Always consult a professional for proper usage and installation.

Infinity™ is a glass mosaic series featuring soothing colors, perfect for any design application and space.

INFINITY™

Glass Mosaic





White Cube



White Arabesque



White 2" Hex

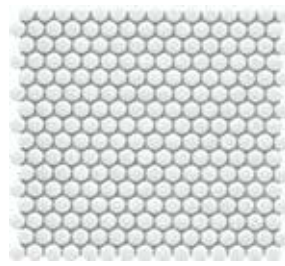

White Penny

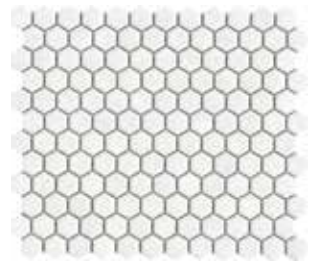

White 1" Hex



Fawn Cube



Fawn Arabesque



Fawn 2" Hex

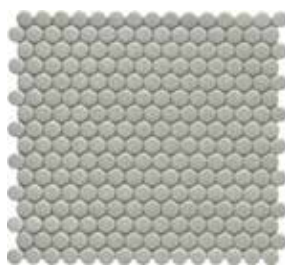

Fawn Penny

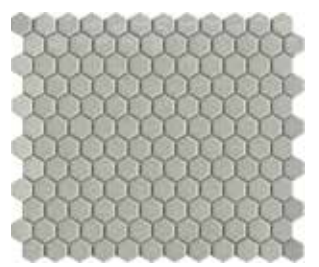

Fawn 1" Hex

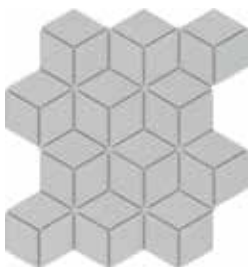

Gray Cube

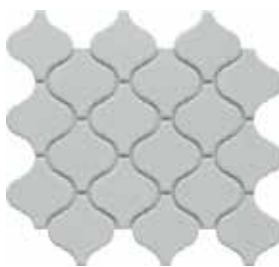

Gray Arabesque



Gray 2" Hex

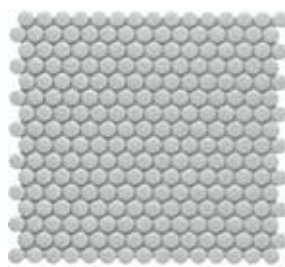

Gray Penny

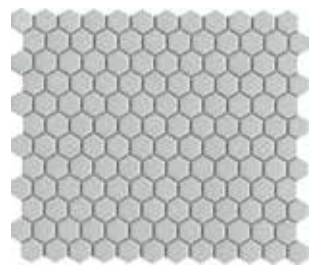

Gray 1" Hex

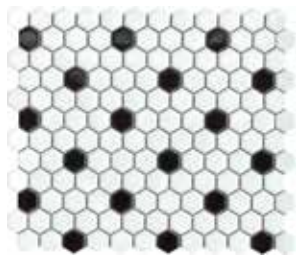

White & Black 1" Hex

Sizes					
	11" x 12" Mesh 11.34" x 12.24"	10" x 12" Mesh 10.16" x 11.73"	10" x 11" Mesh 9.53" x 10.87"	11" x 13" Mesh 10.98" x 12.68"	10" x 12" Mesh 10.41" x 12.05"
Thickness	5.5mm	5.5mm	5.5mm	5.5mm	5.5mm
Testing	Shade Variation Rating				
Results*	VI				

Not Suitable for Commercial Floor Application

- Sustainability Attributes**
- Health Product Declaration (HPD) provided upon request
 - Product Packaging is 100% recyclable
 - VOC Free

*For more information visit www.emser.com. Always consult a professional for proper usage and installation.

The clean, striking look of Influence™ offers a retro vibe in a traditional mosaic. A variety of classic shapes from penny tile to arabesque inspire striking designs. The glossy finish provides enhanced visual interest.

INFLUENCE™

Glazed Porcelain Mosaic



FLOOR / WALL  RESIDENTIAL  COMMERCIAL  INDOOR  OUTDOOR 



Picket Gray



Picket Fawn



Picket Marble





Picket Mirror



Chevron Gray/Fawn | 12"x14"



Chevron Mirror | 12"x12"

Sizes			
	Gray/Fawn 12"x14" Mesh 11.81" x 13.62"	Mirror 12"x12" Mesh 11.73" x 12.05"	11"x15" Mesh 10.59" x 15.04"
Thickness	10mm	8mm	Gray, Fawn, Marble: 10mm Mirror: 8mm
Testing	Shade Variation Rating		
Results*	V2		

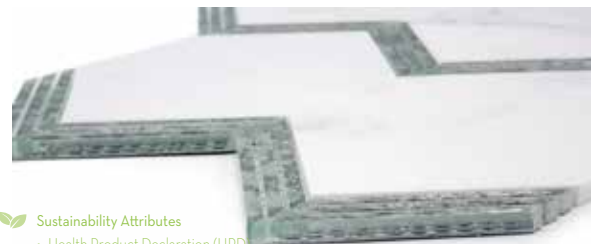

-  Sustainability Attributes
- Health Product Declaration (HPD), provided upon request
 - Product Packaging is 100% recyclable
 - VOC Free

*For more information visit www.emser.com. Always consult a professional for proper usage and installation.

Intrigue™ is inspired by the layers of texture that arise in mixed-material mosaics. A range of neutral overtones are woven together in two design-forward shapes.

INTRIGUE™

Porcelain, Glass & Stone Mosaic



WALL  RESIDENTIAL  COMMERCIAL  INDOOR  OUTDOOR  POOL 



Aura



Coronado

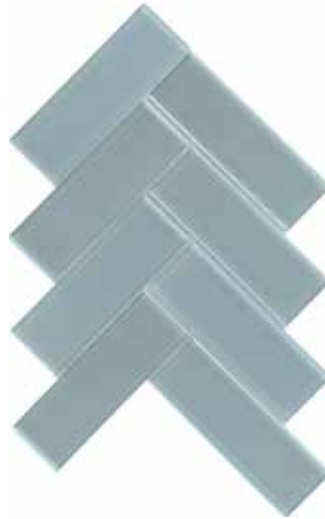

Prism



Spectra

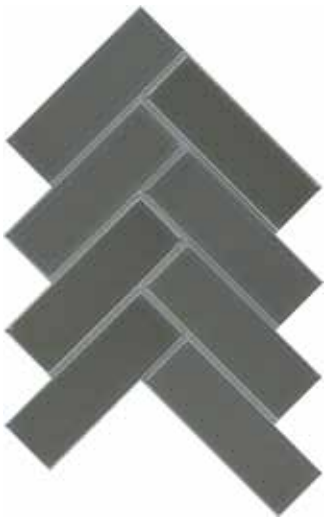

Hue



Optic



Rainbow

Sizes	
	8" x 11" 8.39" x 11.42"
Thickness	5mm
	Aura: 6mm
Testing	Shade Variation Rating
Results*	V3

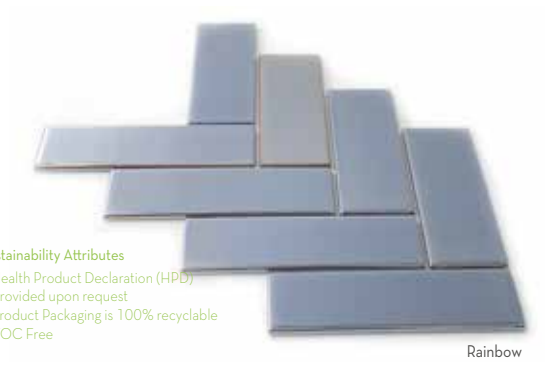

-  Sustainability Attributes
- Health Product Declaration (HPD) provided upon request
 - Product Packaging is 100% recyclable
 - VOC Free

Rainbow

*For more information visit www.emser.com. Always consult a professional for proper usage and installation.

Irish™ is a striking glass mosaic in a fashion-forward herringbone pattern. The glossy finish and cool color palette enable elegant design opportunities.

IRISH™

Glass Mosaic



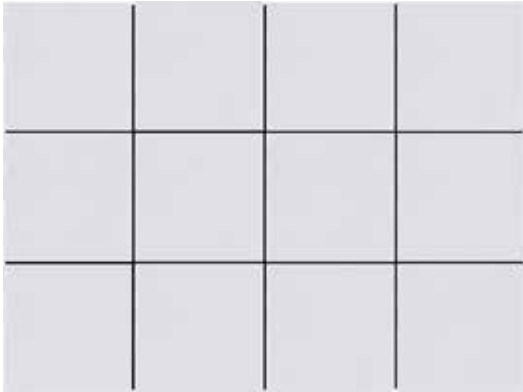

White

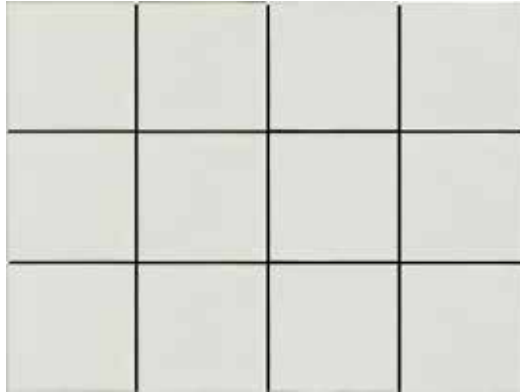

Silver



Taupe



Black



Blue



Green

White Available in Matte & Gloss Finish

<p>Sizes</p>	 <p>12" x 16" 11.75" x 15.67"</p>
<p>Thickness</p>	<p>8mm</p>
<p>Testing</p>	<p>Shade Variation Rating</p>
<p>Results*</p>	<p>V2</p>

- Sustainability Attributes**
- Health Product Declaration (HPD) provided upon request
 - Product Packaging is 100% recyclable
 - VOC Free

*For more information visit www.emser.com. Always consult a professional for proper usage and installation.

Kaze™, a word derived by air, wind, manner and style. Available in six neutral colorways, these mosaics evoke memories of spring and summer. Kaze is the perfect choice to add a serene, naturalness, and earthy feel to your space. Each colorway is offered with various textures and character details creating a tranquil vibe. Kaze coordinates perfectly with Mizu.

KAZE™
Glazed Ceramic Mosaic



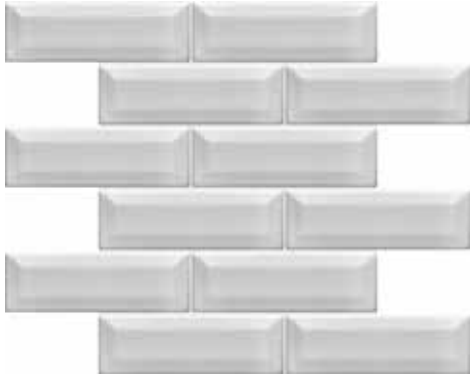

White

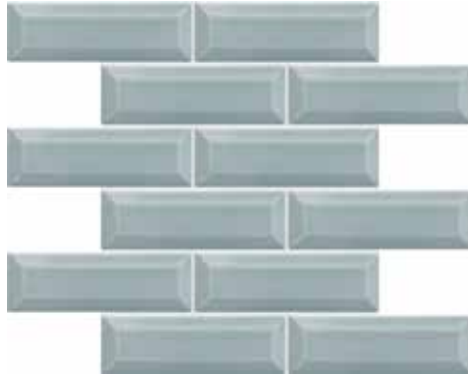

Gray



Skim

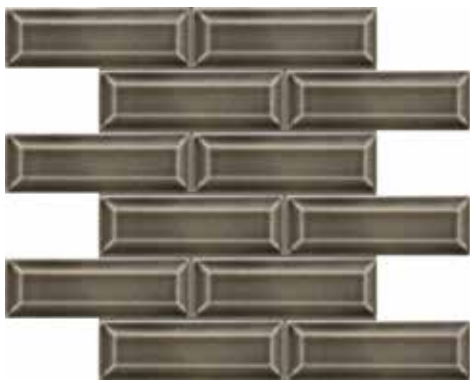

Mink

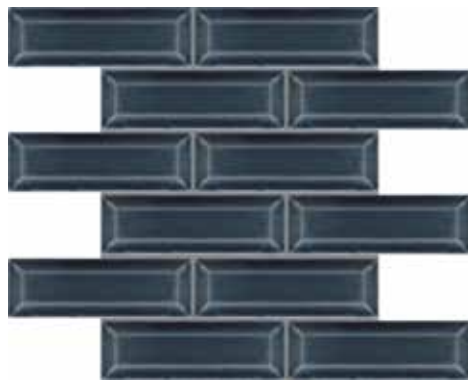

Blue

<p>Sizes</p>	
<p>Thickness</p>	<p>8mm</p>
<p>Testing</p>	<p>Shade Variation Rating</p>
<p>Results*</p>	<p>V2</p>

- Sustainability Attributes**
- Health Product Declaration (HPD) provided upon request
 - Product Packaging is 100% recyclable
 - VOC Free

*For more information visit www.emser.com. Always consult a professional for proper usage and installation.

Add dimension to a room with 3D tiles & instantly get a unique and classic look in any bathroom or kitchen setting with Kinetic™. Kinetic ceramic mosaics create smooth, low-maintenance surfaces and come in 5 different colors. These 3D tiles are versatile for all kinds of applications creating a modern and clean look.

KINETIC™

Glazed Ceramic Mosaic



WALL  RESIDENTIAL  COMMERCIAL  INDOOR  OUTDOOR 



Black

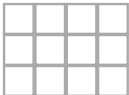

White

Sizes	
	12" x 16" 11.73" x 15.67"
Thickness	10mm
Testing	Shade Variation Rating
Results*	V2

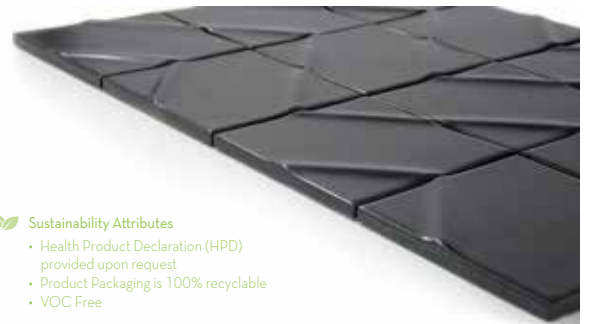

-  Sustainability Attributes
- Health Product Declaration (HPD) provided upon request
 - Product Packaging is 100% recyclable
 - VOC Free

*For more information visit www.emser.com. Always consult a professional for proper usage and installation.

Kumito™ is a timeless ceramic chevron mosaic tile that comes in two distinct colors. The classic choice for both traditional and contemporary design schemes, Kumito provides a simple and clean look with a matte finish. This chevron mosaic is the perfect accent to any wall.

KUMITO™

Glazed Ceramic Mosaic





White



Cream



Silver



Gray

<p>Sizes</p>	 <p>12" x 12" Mesh 11.81" x 11.93"</p>
<p>Thickness</p>	<p>6mm</p>
<p>Testing</p>	<p>Shade Variation Rating</p>
<p>Results*</p>	<p>V2</p>

- Sustainability Attributes**
- Health Product Declaration (HPD) provided upon request
 - Product Packaging is 100% recyclable
 - VOC Free

*For more information visit www.emser.com. Always consult a professional for proper usage and installation.

LaVie™ embraces the beauty in uniqueness. The series features a dynamic stacked vertical mosaic pattern in glass mosaic.

LA VIE™

Glass Mosaic



WALL  RESIDENTIAL  COMMERCIAL  INDOOR  OUTDOOR 



White 3"x3"



White 3"x6"



White 2"x4" Diamond



Kaleidoscope









2"x3" Leaf



Picket

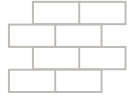

Triad

Sizes							
	12" x 12" 11.73" x 11.69"	10" x 11" 10.03" x 11.42"	12" x 12" 11.97" x 11.65"	12" x 12" 12.05" x 12.05"	9" x 11" 9.17" x 10.59"	10" x 12" 11.5" x 9.76"	12" x 12" 11.73" x 11.73"
Thickness	8mm	8mm	8mm	8mm	8mm	8mm	8mm
Testing	Shade Variation Rating						
Results*	V2						

-  Sustainability Attributes
- Health Product Declaration (HPD) provided upon request
 - Product Packaging is 100% recyclable
 - VOC Free

*For more information visit www.emser.com. Always consult a professional for proper usage and installation.

L'Amour™ recycled glass tile marks the convergence of versatile shapes with sustainability. Fall in love with the family of seven classic shapes including picket, diamond, leaf, triad, kaleidoscope and more. Available in four sizes for maximum adaptability for your next renovation project.

L'AMOUR™

Recycled Glass Mosaic





White 1" Hex



White Cube



White Herringbone







White Linear



White and Gold

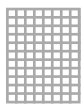

White and Silver

Sizes					
	12" x 17" Mesh 12.09 x 16.93"	12" x 18" Mesh 12 x 17.99"	12" x 18" Mesh 12" x 17.99"	12" x 18" Mesh 12 x 17.99"	12" x 18" Mesh 12.2 x 17.99"
Thickness	8mm	8mm	8mm	8mm	8mm
Testing	Shade Variation Rating				
Results*	V2				

-  Sustainability Attributes
- Health Product Declaration (HPD) provided upon request
 - Product Packaging is 100% recyclable
 - VOC Free

*For more information visit www.emser.com. Always consult a professional for proper usage and installation.

Link™ groutless stone mosaic provides a unique, three dimensional stone look in an easy-to-install format. The beautiful, yet durable, marble stone is ideal for any application. Available in Hex, Cube, Herringbone, Linear designs as well as a modern look with metal accents.

LINK™
Marble Groutless Mosaic



WALL  RESIDENTIAL  COMMERCIAL  INDOOR 



Irving



Melville

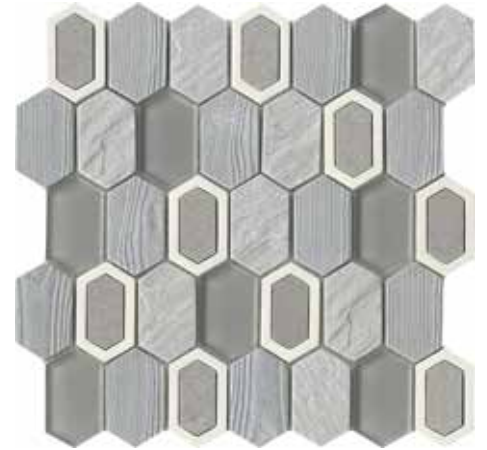

Poe



Stowe

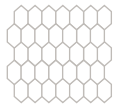

Twain

<p>Sizes</p>  <p>12" x 12" Mesh 11.81" x 11.93"</p>	
<p>Thickness</p>	<p>8mm</p>
<p>Testing</p>	<p>Shade Variation Rating</p>
<p>Results*</p>	<p>V2</p>



-  Sustainability Attributes
- Health Product Declaration (HPD) provided upon request
 - Product Packaging is 100% recyclable
 - VOC Free

*For more information visit www.emser.com. Always consult a professional for proper usage and installation.

Literati™ combines the elements of glass and stone in a striking pattern. Various textures and stone blends add character and charm to this unique collection of mosaics.

LITERATI™

Resin Cast Stone Mosaic



WALL  RESIDENTIAL  COMMERCIAL  INDOOR 



Ambrato Linear



Andrea Linear



Campo Linear



Certosa Linear



Concordia Linear



Grazia Linear



Lido Linear



Murano Linear



Regale Linear



Servolo Linear



Blanc Linear



Morning Fog Linear



Pellestri Blend Linear





Blanc

Cream

Morning Fog

Cielo

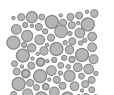
Pewter

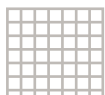
Sizes				
	12"x13" Mesh 11.80"x12.70"	12"x12" Mesh	3"x6" 3.15"x6.42"	13"x13" Mesh
Thickness	8mm	8mm	8mm	8mm
Testing	Shade Variation Rating			
Results*	3"x6" - V1 V2			

-  Sustainability Attributes
- Health Product Declaration (HPD) provided upon request
 - Product Packaging is 100% recyclable
 - VOC Free

*For more information visit www.emser.com. Always consult a professional for proper usage and installation.

Lustrous color shines through in this exclusive glass and stone mosaic line. Lucente™ can be used on its own or combined with wall tile to make a lasting impression.

LUCENTE™

Glass Mosaic



Lucente™ | Certosa Linear



Grazia Pattern



Certosa Pattern



Lido Pattern

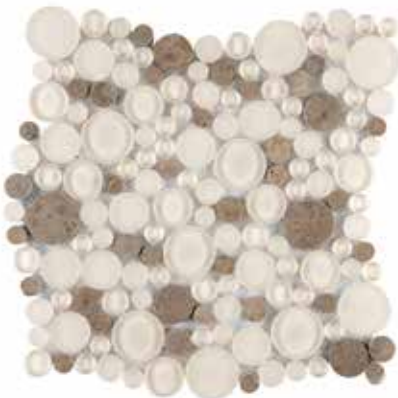

Lidio Circle

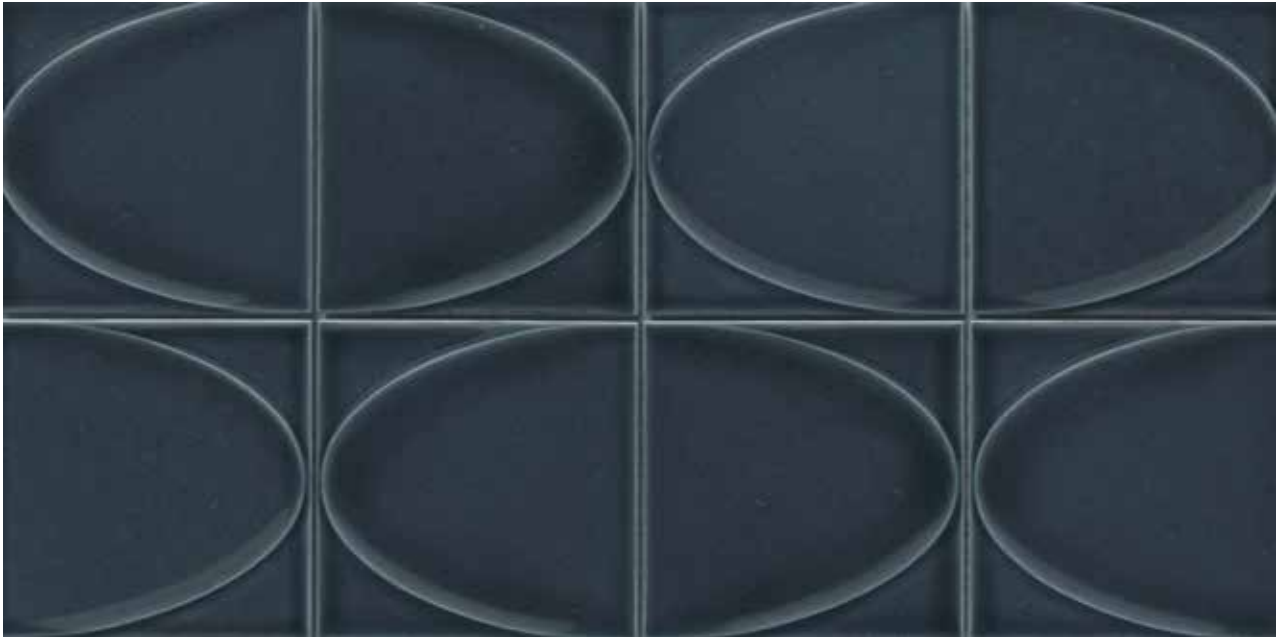

Blue



White



Silver



Taupe



Green

Sizes	
	8" x 16" Mesh 7.80" x 15.67"
Thickness	8mm
Testing	Shade Variation Rating
Results*	V2

- Sustainability Attributes**
- Health Product Declaration (HPD) provided upon request
 - Product Packaging is 100% recyclable
 - VOC Free

*For more information visit www.emser.com. Always consult a professional for proper usage and installation.

Sophisticated and saturated in rich nature-influenced hues, Mizu™ ceramic tile adds equal measures of style and flair in interior design. The celebration of circles is evident in five smart colors that will dress up walls in any room. The graphic pattern is truly an eye-catcher. Mizu coordinates perfectly with Kaze™.

MIZU™
Glazed Ceramic Mosaic





White

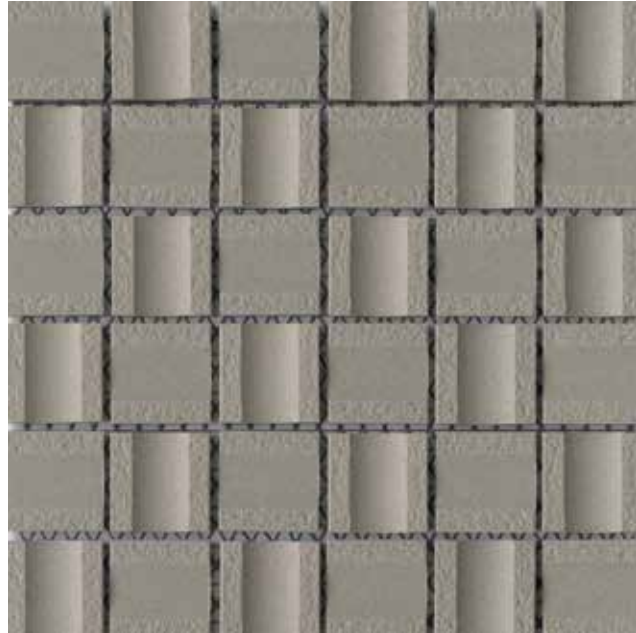

Silver



Rust

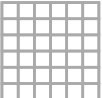

Black

Sizes	
	12" x 12" Mesh 11.69" x 11.69"
Thickness	11mm
Testing	Shade Variation Rating
Results*	V2

It is recommended that the unglazed products be sealed to maintain stain or chemical resistance over-time. Always consult a professional for proper installation and maintenance.

- Sustainability Attributes**
- Health Product Declaration (HPD) provided upon request
 - Product Packaging is 100% recyclable
 - VOC Free

*For more information visit www.emser.com. Always consult a professional for proper usage and installation.

Modan™ porcelain tile is a study in the power of contrasts – smooth and concave, rough and matte, light and shadow. Simple in concept with an appreciation for modern design, Modan calls to the senses, while enhancing any space where this unique tile lives. Four rich colors open the door to possibility.

MODAN™

Unglazed Porcelain Mosaic





Dove



Fawn



Silver

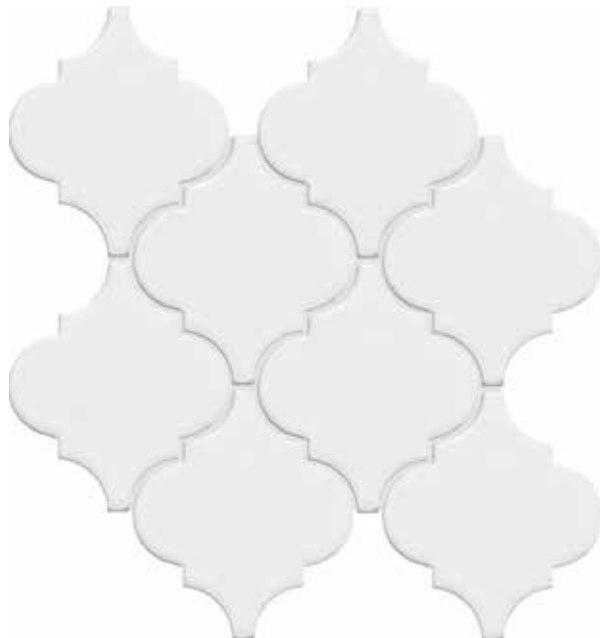

White

<p>Sizes</p>	 <p>10" x 11" Mesh 10.63" x 10.24"</p>
<p>Thickness</p>	<p>8mm</p>
<p>Testing</p>	<p>Shade Variation Rating</p>
<p>Results*</p>	<p>V2</p>

- Sustainability Attributes**
- Health Product Declaration (HPD) provided upon request
 - Product Packaging is 100% recyclable
 - VOC Free

*For more information visit www.emser.com. Always consult a professional for proper usage and installation.

Motifs of Morocco are easily recognizable in this namesake tile. Arabesque shapes in both warm and cool tones add a classic accent to any wall or backsplash application.

MOROCCO™

Glazed Ceramic Mosaic





Arabesque Black



Arabesque Gray



Arabesque White



Petal Black



Petal Gray



Petal White





Wave Black

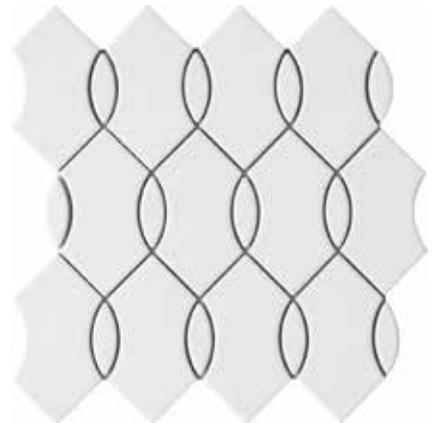

Wave Gray



Wave White

Sizes			
	11" x 12" Mesh 10.63" x 11.75"	11" x 13" Mesh 10.71" x 13.11"	12" x 12" Mesh 12.20" x 12.24"
Thickness	7mm	7mm	7mm
Testing	Shade Variation Rating		
Results*	VI		

- Sustainability Attributes**
- Health Product Declaration (HPD) provided upon request
 - Product Packaging is 100% recyclable
 - VOC Free

*For more information visit www.emser.com. Always consult a professional for proper usage and installation.

Arabesque, petal, and wave motifs are the backbone for Mythos™. The Greek mythology-inspired collection features classic shapes perfect for decorative looks at home. Available in black, gray and white for a seamless fit into any design - while still making a signature impact.

MYTHOS™

Glazed Ceramic Mosaic





White



Silver



Gray

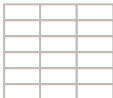

Navy

Sizes	
	11" x 11" 11.42" x 11.12"
Thickness	7mm
Testing	Shade Variation Rating
Results*	V2

- Sustainability Attributes**
- Health Product Declaration (HPD) provided upon request
 - Product Packaging is 100% recyclable
 - VOC Free

*For more information visit www.emser.com. Always consult a professional for proper usage and installation.

Nagara™ ceramic mosaic tile celebrates the ebb and flow between solids and textures. The glossy brick design is a mix of linear texture and subtle shade variations. Available in four timeless colorways, Nagara is a perfect complement for any design aesthetic.

NAGARA™
Glazed Ceramic Mosaic



WALL  RESIDENTIAL  COMMERCIAL  INDOOR  OUTDOOR  POOL 

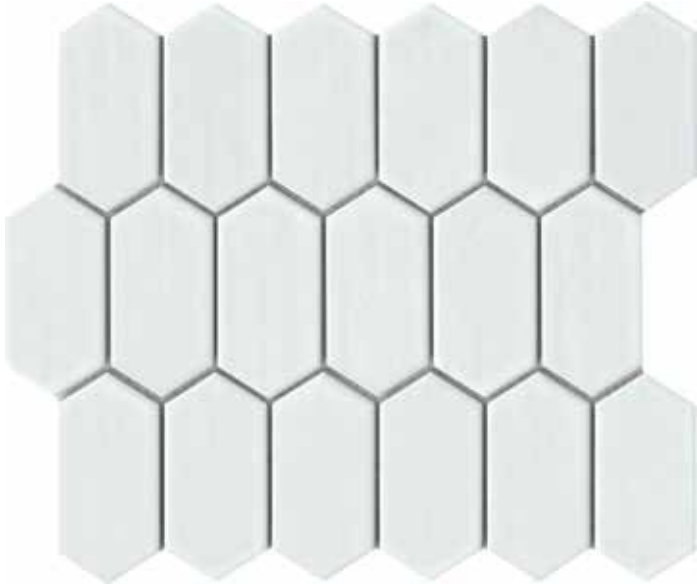

White

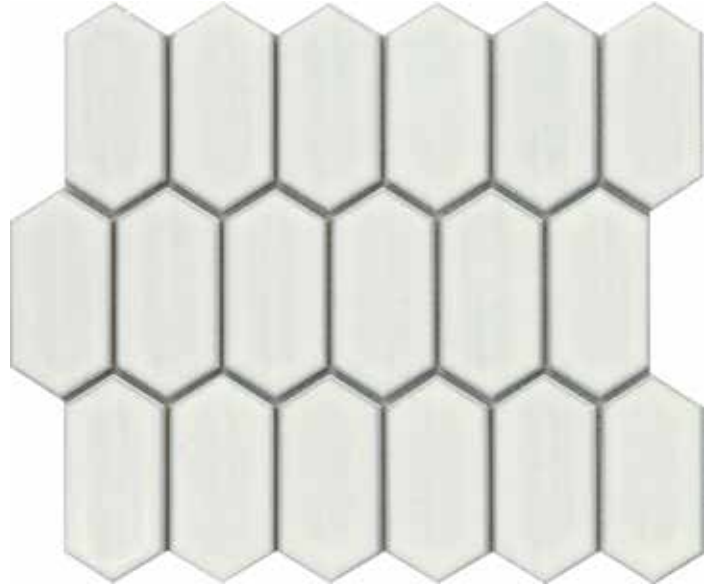

Ivory



Navy

<p>Sizes</p>	 <p>10" x 12" 10.04" x 11.57"</p>
<p>Thickness</p>	<p>7.5mm</p>
<p>Testing</p>	<p>Shade Variation Rating</p>
<p>Results*</p>	<p>V2</p>

-  Sustainability Attributes
- Health Product Declaration (HPD) provided upon request
 - Product Packaging is 100% recyclable
 - VOC Free

*For more information visit www.emser.com. Always consult a professional for proper usage and installation.

Sophisticated, timeless, and always right on trend, Omni™ porcelain mosaic is ideal for modern design. The hexagonal shape, and the color palette itself, inspires. Whether you mix-and-match or choose one – the possibilities are endless. Omni is available in three colors.

OMNI™
Glazed Porcelain Mosaic





Honey



Morning



Silver

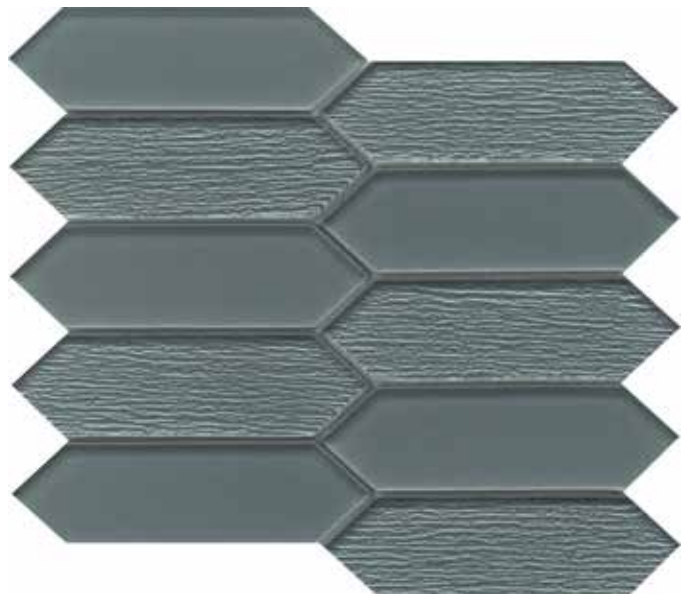

Blue

<p>Sizes</p>  <p>10" x 11" Mesh 9.45" x 10.87"</p>	
<p>Thickness</p>	<p>8mm</p>
<p>Testing</p>	<p>Shade Variation Rating</p>
<p>Results*</p>	<p>VI</p>

-  Sustainability Attributes
- Health Product Declaration (HPD) provided upon request
 - Product Packaging is 100% recyclable
 - VOC Free

*For more information visit www.emser.com. Always consult a professional for proper usage and installation.

Picket™ is inspired by the simplistic angles of a picket fence in a shimmering glass mosaic pattern. With warm tones, the collection exudes a contemporary approach to wall design.

PICKET™

Glass Mosaic





Pearl



Silver

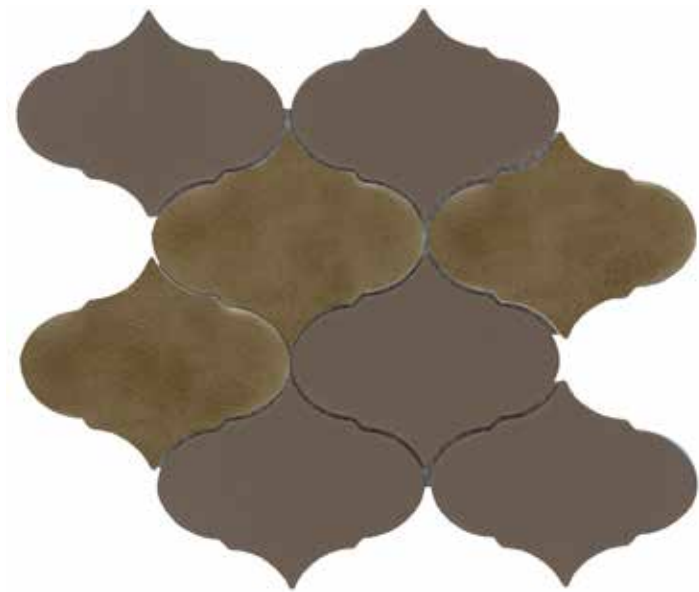

Bronze



Chrome

<p>Sizes</p>	 <p>9" x 10" Mesh 12.32" x 10.63"</p>
<p>Thickness</p>	<p>8mm</p>
<p>Testing</p>	<p>Shade Variation Rating</p>
<p>Results*</p>	<p>V3</p>



-  Sustainability Attributes
- Health Product Declaration (HPD) provided upon request
 - Product Packaging is 100% recyclable
 - VOC Free

*For more information visit www.emser.com. Always consult a professional for proper usage and installation.

Retro II™ revisits a classic mod-inspired mosaic with a unique blend of metallic and crackled finishes. Each hue expresses a slightly different contrasting color, enhancing the crackled texture.

RETRO II™

Resin & Porcelain Mix Mosaic



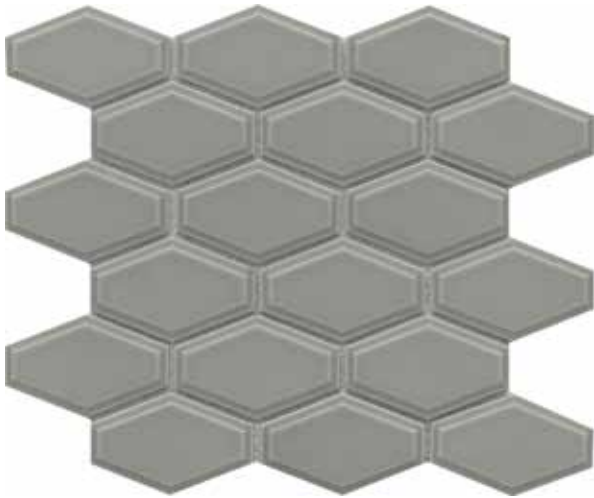

Dove

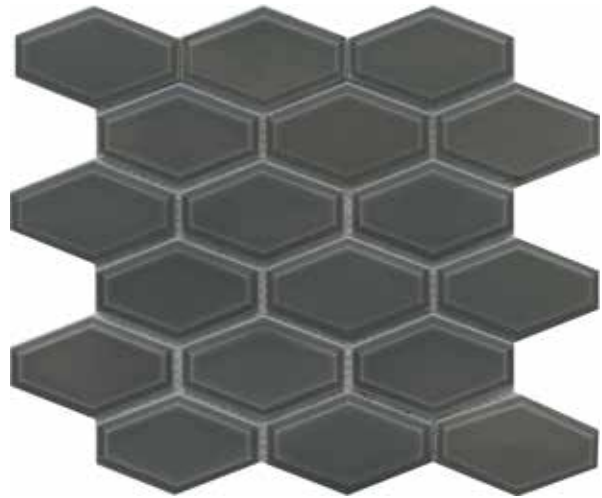

Gray

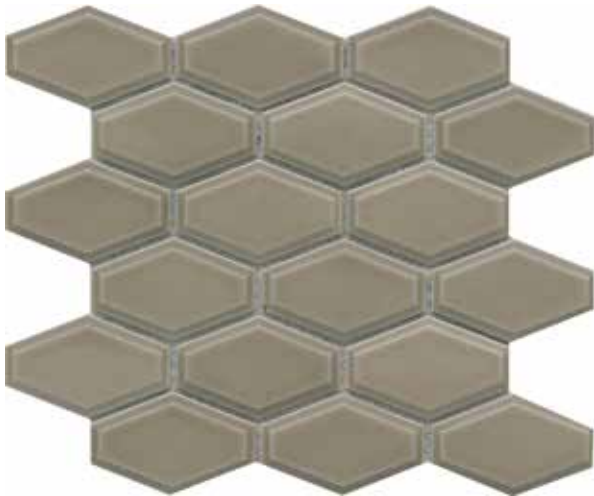

Taupe

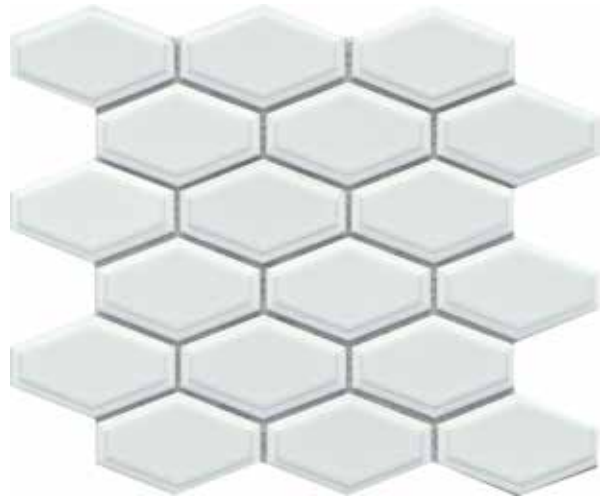

White



All Colors Also Available in Fan and 3"x6" Beveled Patterns

Sizes			
	11"x12"	10"x11"	10"x11"
Thickness	6mm	6mm	7mm
Testing	Shade Variation Rating		
Results*	V2		

- Sustainability Attributes**
- Health Product Declaration (HPD) provided upon request
 - Product Packaging is 100% recyclable
 - VOC Free

*For more information visit www.emser.com. Always consult a professional for proper usage and installation.

Reward™ porcelain tile celebrates geometric shapes with classic elongated hexagons, bricks and curvy fish scales. Even in simplicity, these tiles are styled to make a signature and durable moment for those investing in their next home renovation or design project.

REWARD™
Glazed Porcelain Mosaic



FLOOR / WALL  RESIDENTIAL  INDOOR  OUTDOOR  POOL 

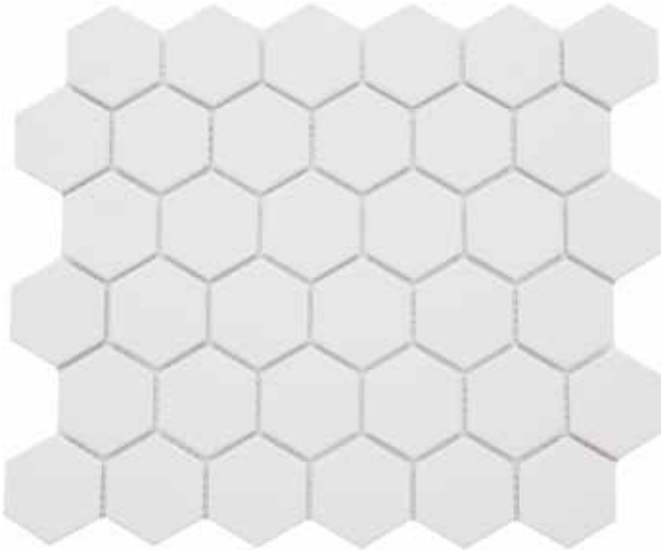

White 2" Hex

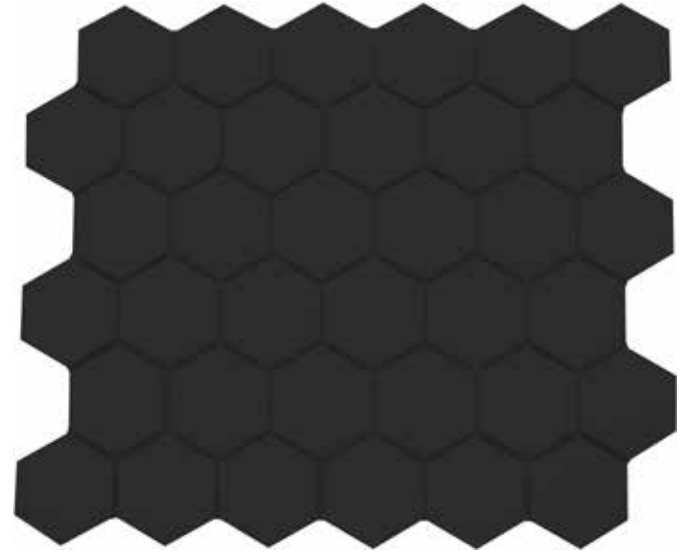

Black 2" Hex

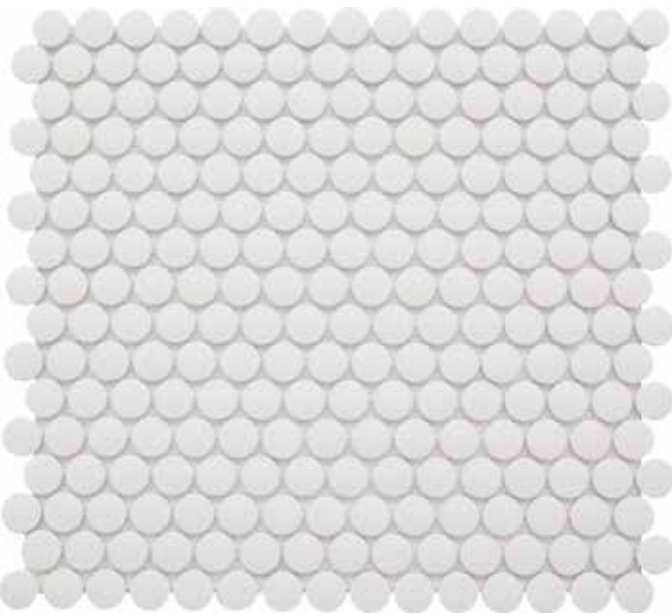

White Penny

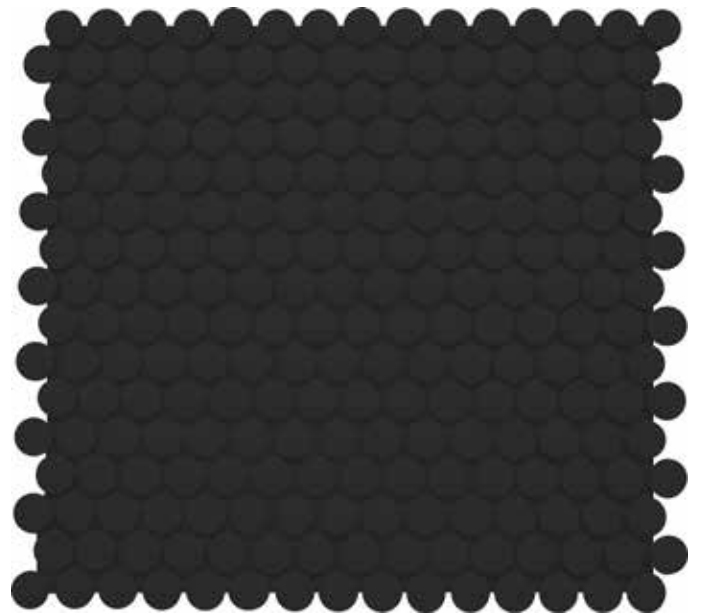

Black Penny

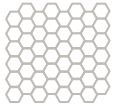
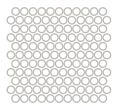
Sizes		
	11" x 13" 10.98" x 12.68"	11" x 12" 11.34" x 12.24"
Thickness	5.5mm	5.5mm
Testing	Shade Variation Rating	
Results*	VI	

-  Sustainability Attributes
- Health Product Declaration (HPD) provided upon request
 - Product Packaging is 100% recyclable
 - VOC Free

*For more information visit www.emser.com. Always consult a professional for proper usage and installation.

Give any room a patterned, finished look with the classic simplicity of Rezone™. The clean lines of this all white mosaic add a sense of calm and order in a range of applications.

REZONE™

Unglazed Porcelain Mosaic



Rezone™ | White 2" Hex



Rezone™ | White Penny

FLOOR / WALL  RESIDENTIAL  COMMERCIAL  INDOOR  OUTDOOR 



Natural Blend



Cream



Gold



4 Color Blend



Black

<p>Sizes</p>  <p>12" x 12" Mesh 11.81" x 11.81"</p> <p>Thickness</p> <p>9.5mm</p>	
<p>Testing</p> <p>Shade Variation Rating</p> <p>Results* V2</p>	

-  Sustainability Attributes
- Health Product Declaration (HPD) provided upon request
 - Product Packaging is 100% recyclable
 - VOC Free

*For more information visit www.emser.com. Always consult a professional for proper usage and installation.



Rivera Pebbles™ recalls the burnished stones that grace the famous beaches along the French Riviera. Available on interlocking mesh, Rivera Pebbles™ brings a relaxed harmony to interior spaces.

RIVERA PEBBLES™

Flat Pebble Mosaic



FLOOR / WALL  RESIDENTIAL  COMMERCIAL  INDOOR  OUTDOOR  POOL 

1" Hex on 11"x11"



Pure White



Fawn

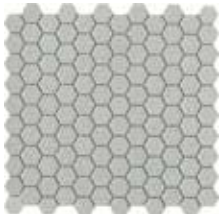

Gray



Taupe

Salt & Pepper



White

3" Hex on 9"x10"



Fawn

2"x2" on 12"x12"

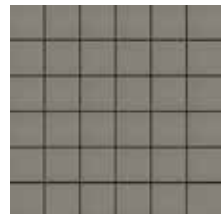
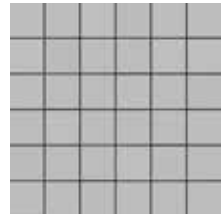
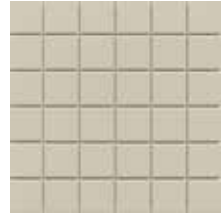
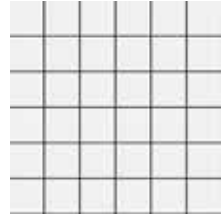

Cider

1" Hex on 11"x11"

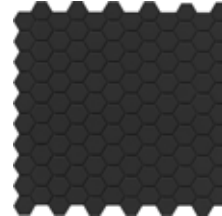

Black

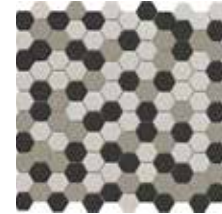

Dark Blend



Light Blend







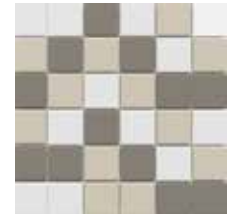

3" Hex on 9"x10"

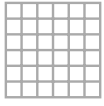

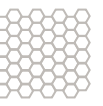
2"x2" on 12"x12"



Black

Sizes							
	12"x12" Mesh 11.69"x11.69"	9"x10" Mesh 8.66"x9.88"	11"x11" Mesh 11.42"x11.02"	2"x2" Floor SBN	2"x2" Cove Base	2"x2" SBN Corner	
Thickness	6mm	6mm	6mm				
Testing	Shade Variation Rating						<p> Sustainability Attributes</p> <ul style="list-style-type: none"> • Health Product Declaration (HPD) provided upon request • Product Packaging is 100% recyclable • VOC Free
Results*	VI						

*For more information visit www.emser.com. Always consult a professional for proper usage and installation.

The clean, natural design aesthetic of Source™ is amplified through its neutral color palette. The contemporary shapes and smooth, matte finish make Source the tile of choice.

SOURCE™

Unglazed Porcelain Mosaic



FLOOR / WALL  RESIDENTIAL  COMMERCIAL  INDOOR  OUTDOOR  POOL 

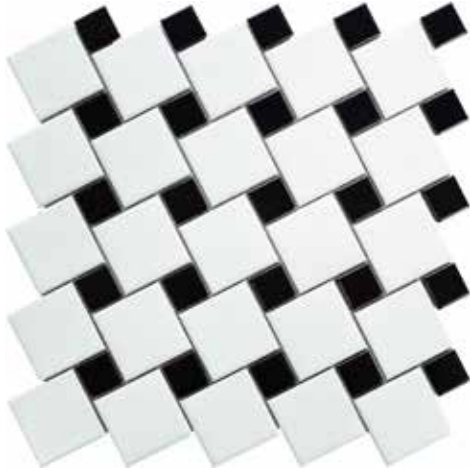

White - Black



White - Fawn



White - Gray

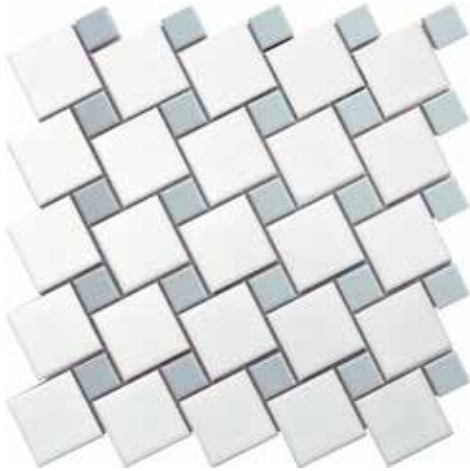

White - Silver



White - White

<p>Sizes</p>  <p>11" x 11" Mesh 11.02" x 11.02"</p> <p>Thickness</p> <p>5,5mm</p>	
<p>Testing</p> <p>Shade Variation Rating</p> <p>Results* VI</p>	

-  Sustainability Attributes
- Health Product Declaration (HPD) provided upon request
 - Product Packaging is 100% recyclable
 - VOC Free

*For more information visit www.emser.com. Always consult a professional for proper usage and installation.

The vintage appeal of the classic pinwheel pattern comes home with Spin™ mosaic tile. The linear style offers a neutral option, while still celebrating layered looks and movement in design. The allure of this geometric mosaic remains ever-present today for its beauty and durability, especially for both kitchen and bath.

SPIN™

Glazed Porcelain Mosaic

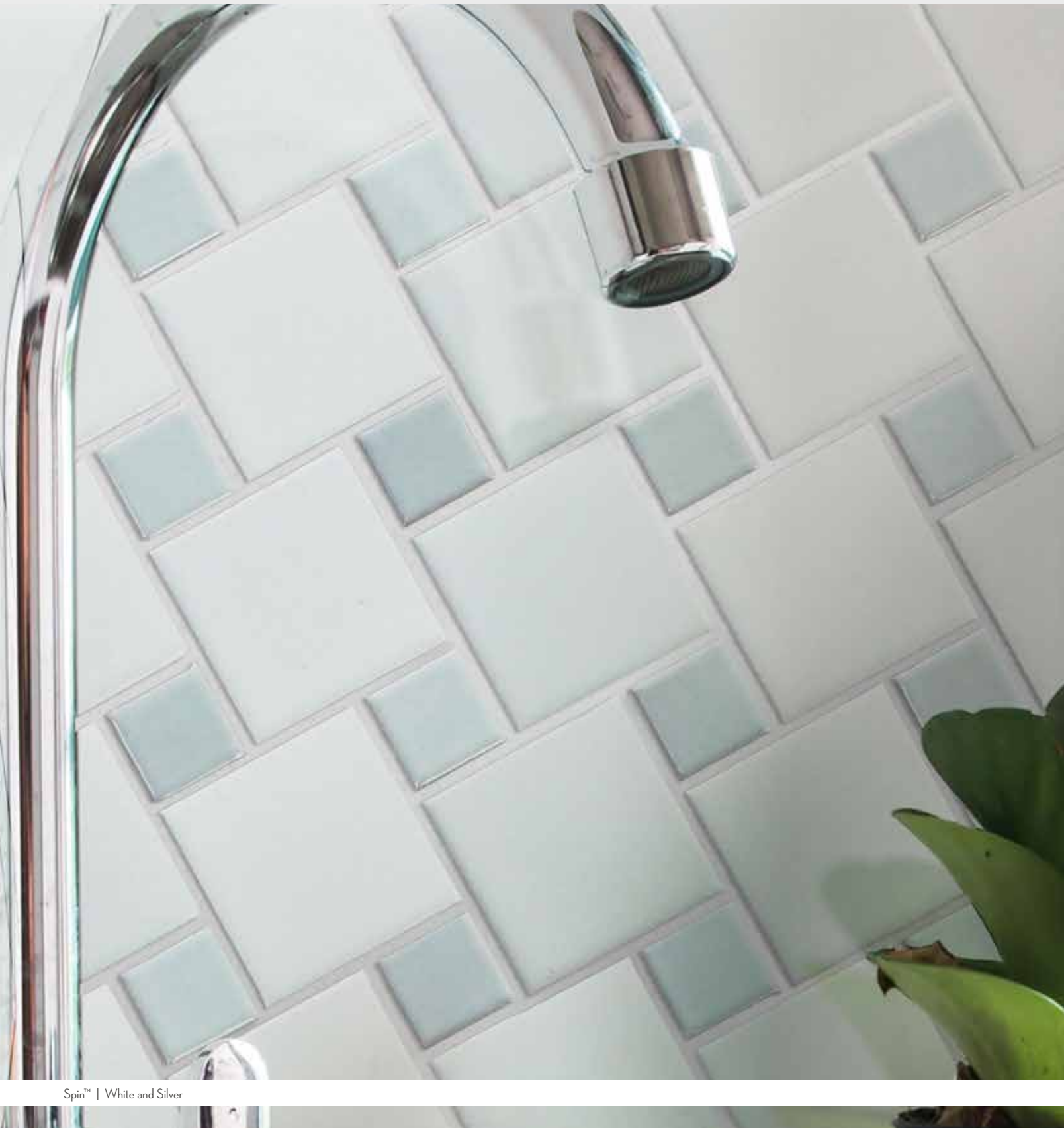

WALL  RESIDENTIAL  COMMERCIAL  INDOOR  OUTDOOR  POOL 



White



Silver



Tan



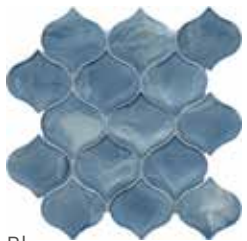

Moss



Blue

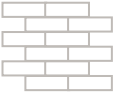
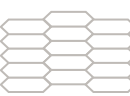

Sizes				
	11" x 12" Mesh 12.40" x 10.71"	10" x 10" Mesh 10.12" x 9.76"	12" x 13" Mesh 12.2" x 12.52"	10" x 14" Mesh 9.92" x 13.78"
Thickness	6mm	6mm	6mm	6mm
Testing	Shade Variation Rating			
Results*	V4			

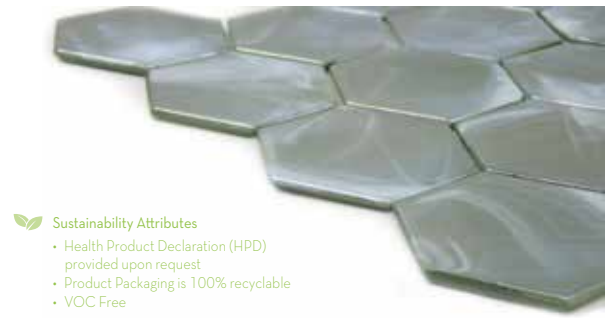

-  Sustainability Attributes
- Health Product Declaration (HPD) provided upon request
 - Product Packaging is 100% recyclable
 - VOC Free

*For more information visit www.emser.com. Always consult a professional for proper usage and installation.

Geometry and whimsy meet to make a splash with one of Emser's latest collections of decorative glass tiles. Invite modern backsplashes and bold surface designs to today's kitchens, baths, accent walls, and pools. Made of molten glass, the swirl design of each piece is unique making this a one-of-a-kind tile. A dazzling iridescent finish available in five colorways: White, Silver, Tan, Moss, and Blue.

SPLASH™

Glass Mosaic





Ballad



Haiku



Epic



Poem

<p>Sizes</p>  <p>12" x 12" Mesh 12.15" x 12.05"</p>	
<p>Thickness</p>	<p>4mm</p>
<p>Testing</p>	<p>Shade Variation Rating</p>
<p>Results*</p>	<p>V3</p>

-  Sustainability Attributes
- Health Product Declaration (HPD) provided upon request
 - Product Packaging is 100% recyclable
 - VOC Free

*For more information visit www.emser.com. Always consult a professional for proper usage and installation.

Unique™ is an exclusive combination of glass and stone blend mosaics, creating a modern look. This fabulous mosaic series includes a variety of colors to allow for versatile design options.

UNIQUE™
Glass & Stone Mosaic



FLOOR / WALL  RESIDENTIAL  COMMERCIAL  INDOOR  OUTDOOR  POOL 



Ivory



Tan



Silver



Multicolor



4 Color Blend



Medici Blend



Italia Blend



Pastel Blend



Gelato Blend

<p>Sizes</p> <p>Thickness</p>	 <p>12" x 12" Mesh 11.81" x 11.81"</p> <p>8mm</p>
<p>Testing</p> <p>Results*</p>	<p>Shade Variation Rating</p> <p>V2</p>

-  Sustainability Attributes
- Health Product Declaration (HPD) provided upon request
 - Product Packaging is 100% recyclable
 - VOC Free

*For more information visit www.emser.com. Always consult a professional for proper usage and installation.

Inspired by the beauty of Venice, Venetian Pebbles™ creates a historic yet beautiful statement. Available on interlocking mesh, Venetian Pebbles™ brings a traditional, historic look to interior spaces.

VENETIAN PEBBLES™

Flat Pebble Mosaic



WALL  RESIDENTIAL  COMMERCIAL  INDOOR  OUTDOOR 



Aria



Cieli



Nebbia



Nuvole

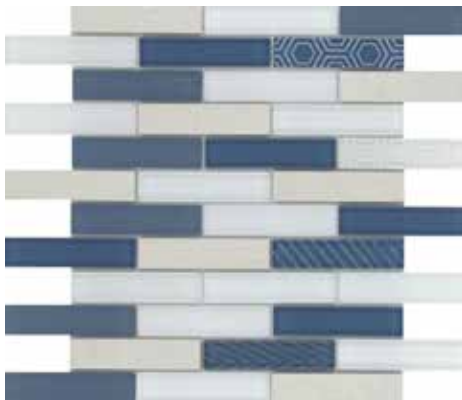

Stella



Vento

<p>Sizes</p>	 <p>12" x 12" Mesh 11.75" x 11.75"</p>
<p>Thickness</p>	<p>8mm</p>
<p>Testing</p>	<p>Shade Variation Rating</p>
<p>Results*</p>	<p>V2</p>

-  Sustainability Attributes
- Health Product Declaration (HPD) provided upon request
 - Product Packaging is 100% recyclable
 - VOC Free

*For more information visit www.emser.com. Always consult a professional for proper usage and installation.

Volare™ highlights subtle geometric-inspired accents within a small-scale linear mosaic. Glass invites a myriad of texture variations to each color within the series, ranging from dynamic grays to blues to black.

VOLARE™

Glass & Porcelain Mosaic



FLOOR / WALL  RESIDENTIAL  COMMERCIAL  INDOOR  OUTDOOR  POOL 



Mana

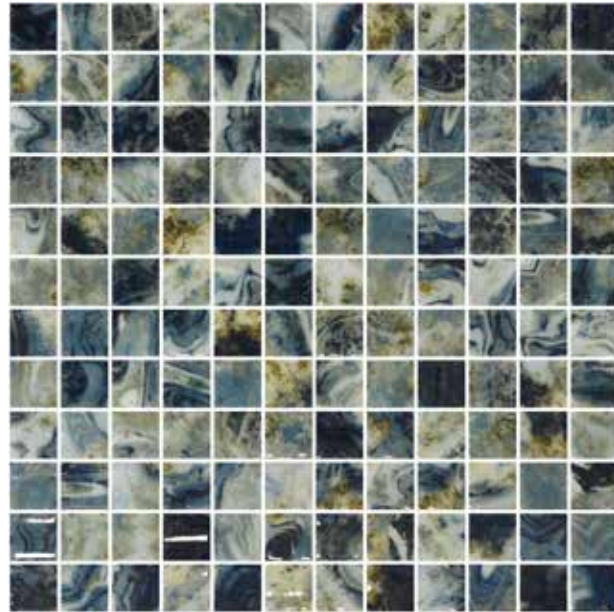

Ono

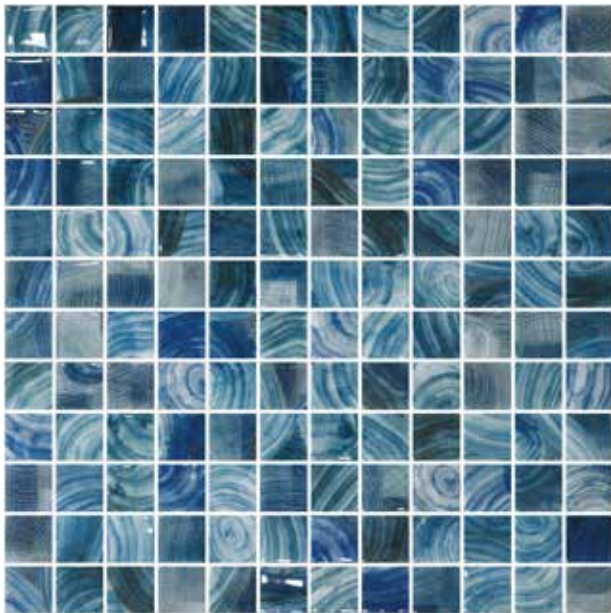

Suva

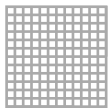
<p>Sizes</p>	 12" x 12" Dot Mount
<p>Thickness</p>	4.9mm
<p>Testing</p>	Shade Variation Rating
<p>Results*</p>	Check Website

-  Sustainability Attributes
- Health Product Declaration (HPD) provided upon request
 - Product Packaging is 100% recyclable
 - VOC Free

*For more information visit www.emser.com. Always consult a professional for proper usage and installation.

Delve below the surface with an homage to the beauty and complexity of water colors. Waterlace™ glass mosaic tile turns designs into geometric works of art. Uniquely yours and suitably indoor and out, for pools, signature walls and floors.

WATERLACE™
Glass Mosaic



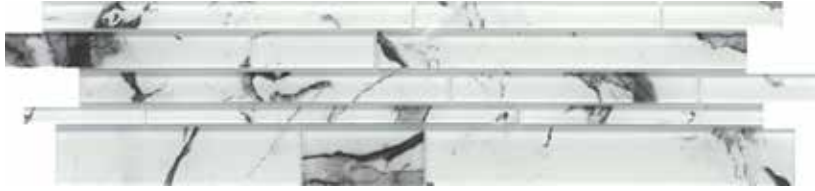

Bliss



Calm



Ease



Peace



Quiet



Serene

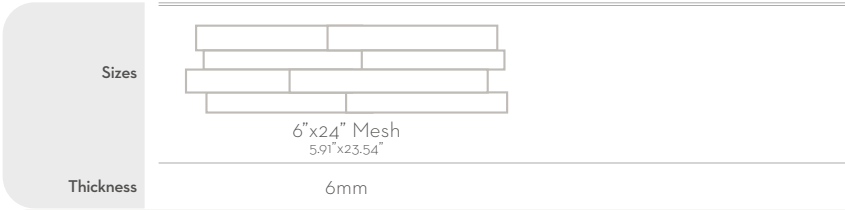

Testing	Shade Variation Rating
Results*	V2

- Sustainability Attributes**
- Health Product Declaration (HPD) provided upon request
 - Product Packaging is 100% recyclable
 - VOC Free

*For more information visit www.emser.com. Always consult a professional for proper usage and installation.

Zen™ is an alluring glass mosaic series that encapsulates contemporary motifs. High-definition printing achieves soothing movement influenced by marble and wood looks. Inspiring peaceful interiors, Zen™ is ideal for kitchen and bath surfaces and backsplashes.

ZEN™
Glass Mosaic





Marble • Bianco Gioia



NATURAL STONE

FLOOR / WALL



RESIDENTIAL



COMMERCIAL



INDOOR



Parian White | V2
24"x24", 18"x18", 12"x24"



Breccia Oniciata | V4
12"x12"



Milano | V3
18"x18"

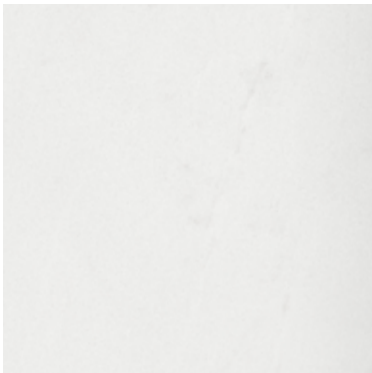

Thassos | V2
24"x24", 18"x18", 12"x24", 12"x12", 3"x6"



Summit Ivory | V3
18"x18", 12"x24", 6"x12" | Honed

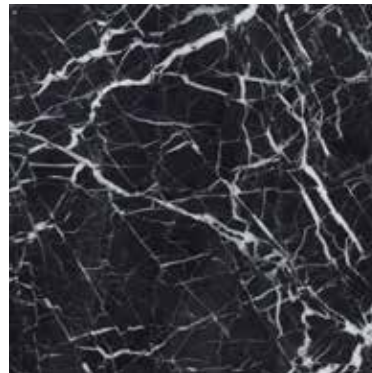

Black & White | V3
12"x12"



Crema Marfil Classico | V3
24"x24", 18"x18", 12"x24", 12"x12", 3"x6"



Crema Marfil Plus | V2
24"x24", 18"x18", 12"x24" | Polished
18"x18", 12"x24" | Honed



Crema Marfil Classico
1"x12" Mini Cigaro

Sizes



24"x24"



18"x18"



12"x24"



12"x12"



6"x12"



3"x6"

Testing

Shade Variation
Rating

Results* VARIES BY COLOR

*For more information visit www.emser.com. Always consult a professional for proper usage and installation.

Marble varies in color and veining from stone to stone. The naturally occurring variations contribute to its distinctive appeal. Polishing achieves a glossy finish that enhances the colors of this timeless classic.

MARBLE

Polished & Honed



FLOOR / WALL



RESIDENTIAL



COMMERCIAL



INDOOR

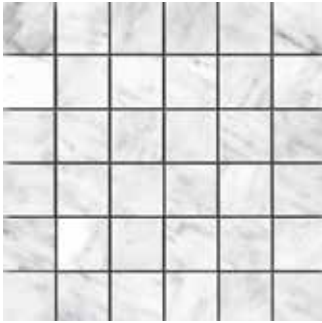

2"x2" on 12"x12" Mesh Polished



2"x4" Bevel on 12"x12" Mesh Polished



3D Linear on 12"x12" Mesh Polished



Chevron on 12"x12" Mesh Polished



Convex on 12"x12" Mesh Polished



Daisy on 12"x13" Mesh Polished



Diamond on 10"x13" Mesh Polished



Gem on 12"x12" Mesh Polished

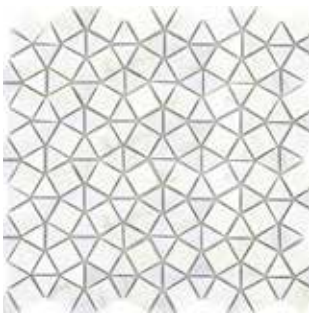

Geometric on 12"x12" Mesh Polished



Hex 1" Mix on 12"x12" Mesh Mixed Finish



Hex 2" Mix on 12"x12" Mesh Mixed Finish

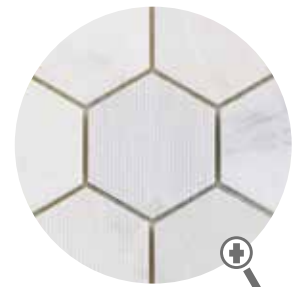

Hexagon 2" Mix

Sizes



24"x24"



18"x18"



12"x24"



12"x12"

Testing

Shade Variation Rating

Results* V2 - V3

Trim



1"x12" Cigaro | Polished



1/2"x12" Mini Cigaro | Polished



2"x12" OG | Polished



1"x2" OG Corner | Polished

*For more information visit www.emser.com. Always consult a professional for proper usage and installation.

WINTER FROST

Polished & Honed



Hexagon Large on 12"x12"
Mesh | Polished



Hexagon Wide on 12"x12" Mesh
| Polished



Lantern on 12"x12" Mesh
Polished



Leaf on 9"x10" Mesh
Polished



Linear on 12"x12" Mesh
Polished



Marquise on 12"x12" Mesh
Polished

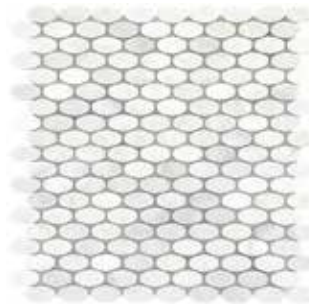

Oval on 12"x12" Mesh
Polished



Penny on 12"x12" Mesh
Polished



Prism on 12"x12" Mesh
Polished



Twine on 11"x13" Mesh
Polished



24"x24", 18"x18", 12"x24", 12"x12" | Polished
12"x24", 3"x6" | Honed

FLOOR / WALL  RESIDENTIAL  COMMERCIAL  INDOOR 



24"x24", 18"x18", 12"x24", 12"x12", 4"x8", 3"x6" | Polished
 18"x18", 12"x24", 12"x12", 4"x8", 3"x6" | Honed





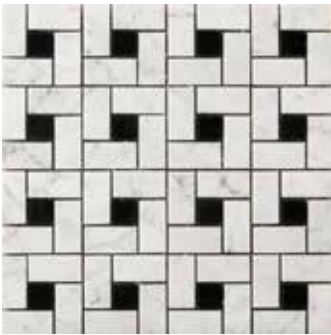

1"x12" Mini Cigaro | Honed & Polished



Pinwheel on 12"x12" Mesh
 Honed



Hexagon 1" on 12"x12" Mesh
 Honed

Sizes						
	24"x24"	18"x18"	12"x24"	12"x12"	4"x8"	3"x6"
Testing	Shade Variation Rating					
Results*	V3					

*For more information visit www.emser.com. Always consult a professional for proper usage and installation.

MARBLE

Polished & Honed



FLOOR / WALL



RESIDENTIAL



COMMERCIAL



INDOOR



18"x18", 12"x24" 12"x12", 4"x8" | Polished



Linear on 12"x13" Mesh Polished



Hexagon 1" on 12"x12" Mesh Polished

1"x12" Mini Cigaro | Polished



Sizes



Testing

Shade Variation Rating

Results* V3

*For more information visit www.emser.com. Always consult a professional for proper usage and installation.





Bianco

24"x24", 18"x18", 12"x24", 12"x12", 4"x8", 3"x6" | Polished
 Coordinating Mosaics Available in the Marble Winter Frost Collection







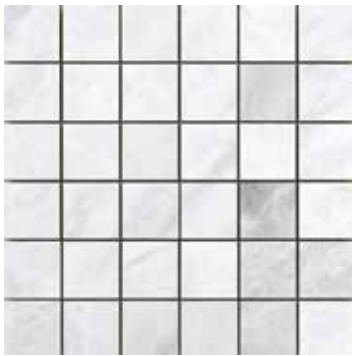



Fiore

32"x32", 24"x24", 18"x18", 16"x32", 12"x24", 12"x12" | Polished



Bianco 2"x2" Mosaic on 12"x12" Mesh
 Honed

Sizes								
	32"x32"	24"x24"	18"x18"	16"x32"	12"x24"	12"x12"	4"x8"	3"x6"
Testing	Shade Variation Rating							
Results*	V3							

*For more information visit www.emser.com. Always consult a professional for proper usage and installation.

FLOOR / WALL



RESIDENTIAL



COMMERCIAL



INDOOR

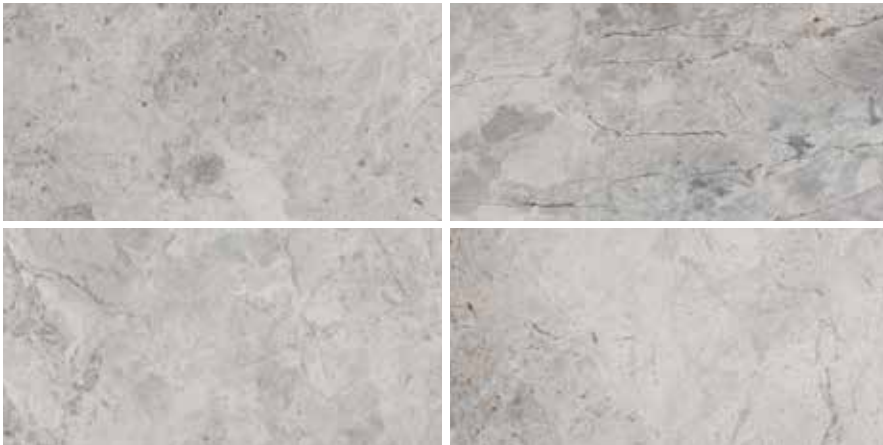

4"x8" | Polished



Pinwheel on 12"x12" Mesh
Polished

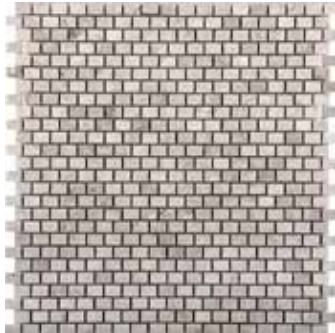

Mini Offset on 12"x12" Mesh
Polished



Hexagon 1" on 12"x12" Mesh
Polished



1/2"x12" Mini Cigaro | Polished

Sizes



4"x8"

Testing

Shade Variation
Rating

Results* V3

*For more information visit www.emser.com. Always consult a professional for proper usage and installation.

FLOOR / WALL 

RESIDENTIAL 

COMMERCIAL 

INDOOR 



Vicenza Cloud
12"x24", 6"x12" | Polished



Vicenza Gray Hexagon Wide on
12"x12" Mesh | Polished



Vicenza Nite
18"x18", 12"x24", 6"x12" | Honed



Vicenza White Hexagon Wide on 12"x12"
Mesh | Polished

Sizes



18"x18"



12"x24"



6"x12"

Testing

Shade Variation
Rating

Results* V3

FLOOR / WALL  RESIDENTIAL  COMMERCIAL  INDOOR  OUTDOOR 



Blue | 12"x24" | Honed



Blue Striated & Chiseled | 12"x24"



Blue Linear | 12"x24" | Honed



3D on 6"x24" Mesh | Honed



Splitface on 6"x24" Mesh

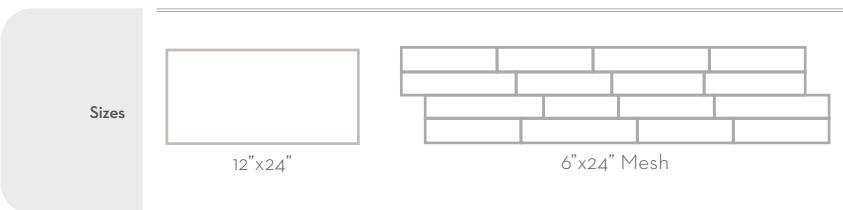

Sizes	12"x24"	6"x24" Mesh
Testing	Shade Variation Rating	
Results*	V3	

*For more information visit www.emser.com. Always consult a professional for proper usage and installation.

The Metro series offers collections of limestone in a contemporary linear design, along with a variety of mosaics to complete the look of your space.

METRO

Limestone Honed



LARGE FORMAT 

FLOOR / WALL 

RESIDENTIAL 

COMMERCIAL 

INDOOR 

OUTDOOR 



16"x32", 12"x24", 6"x24", 3"x6" | Honed



2"x2" on 12"x12" Mesh Honed



2"x4" Bevel on 12"x12" Mesh Honed



3D Linear on 12"x12" Mesh Honed



Chevron on 12"x12" Mesh Honed



Convex on 12"x12" Mesh Honed



Gem on 12"x12" Mesh Honed



Geometric on 12"x12" Mesh Honed



Hexagon 1" Mix on 12"x12" Mesh Mixed Finish



Hexagon 2" Mix on 12"x12" Mesh | Mixed Finish



Hexagon Large on 12"x12" Mesh | Honed



Hexagon Wide on 12"x12" Mesh Honed



Lantern on 12"x12" Mesh Honed



Leaf on 9"x10" Mesh Honed



Linear on 12"x13" Mesh Honed

Sizes



Testing

Shade Variation Rating

Results* V3

1"x12" Mini Cigaro Honed

Twine on 11"x13" Mesh Honed

*For more information visit www.emser.com. Always consult a professional for proper usage and installation.

FLOOR / WALL  RESIDENTIAL  COMMERCIAL  INDOOR  OUTDOOR 



12"x24" | Honed



3D Linear on 12"x12" Mesh
Honed



Chevron on 12"x12" Mesh
Honed



Convex on 12"x12" Mesh
Honed



Hexagon 1" Mix on 12"x12"
Mesh | Mixed Finish



Hexagon 2" Mix on 12"x12"
Mesh | Mixed Finish



Hexagon Large on 12"x12"
Mesh | Honed



Lantern on 12"x12" Mesh
Honed



Marquise on 12"x12" Mesh
Honed



1"x12" Mini Cigaro | Honed

Sizes

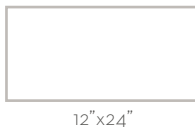

12"x24"

Testing

Shade Variation
Rating

Results* V3

*For more information visit www.emser.com. Always consult a professional for proper usage and installation.

FLOOR / WALL  RESIDENTIAL  COMMERCIAL  INDOOR  OUTDOOR 



Silver | V4 Variation

16"x24", 16"x16", 8"x16", 8"x8", 6"x6", 4"x4", 3"x6"



Hamlet Mini Split Face Offset | V4 Variation

Philadelphia on 6"x12" Mesh



Silver Mini Versailles



Silver 2"x4" Offset



Silver Splitface Offset 1"x2"



Silver 1"x2" Offset



Silver 2"x2"



Silver Pebble



Beige/Mocha Pebble Blend



1 1/2"x12" Beige Mini Cigaro



1 1/2"x12" Mini Cigaro



1"x12" Cigaro

Sizes



Testing

Shade Variation
Rating

Results* VARIES BY COLOR

Trav Ancient Tumbled™ stone features neutral colors in multiple sizes and mosaics. This series is notable for its versatility.

TRAVERTINE

Antique & Tumbled Stone



FLOOR / WALL  RESIDENTIAL  COMMERCIAL  INDOOR  OUTDOOR 



Umbria Savera | Banded Set



Umbria Bruno | Banded Set



Silver | Banded Set



Scabos | Banded Set

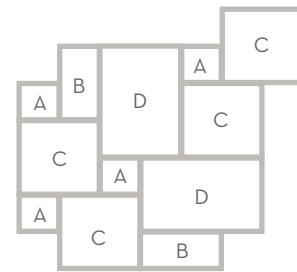

Versailles Pattern | 4 Sizes

An Iteration of this pattern is 16 SF.

- A - 8"x8" - 4 Pieces
- B - 8"x16" - 2 Pieces
- C - 16"x16" - 4 Pieces
- D - 16"x24" - 2 Pieces







Umbria Savera
16"x24", 16"x16"



Valencia
16"x16"



Vanilla Coffee
16"x24", 16"x16", 8"x16", 8"x8"

Sizes				
	16"x24"	16"x16"	8"x16"	8"x8"
Testing	Shade Variation Rating			
Results*	V4			

*For more information visit www.emser.com. Always consult a professional for proper usage and installation.

FLOOR / WALL  RESIDENTIAL  COMMERCIAL  INDOOR  OUTDOOR 



Ivory Classic
4"x4", 3"x6"

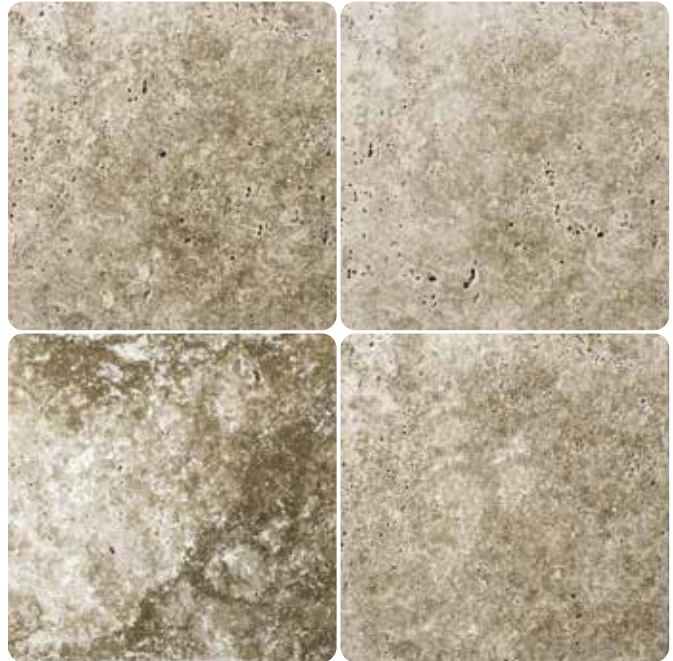

Walnut
4"x4", 3"x6"

Sizes



4"x4"



3"x6"

Testing

Shade Variation
Rating

Results* V3

FLOOR / WALL



RESIDENTIAL



COMMERCIAL



INDOOR



Ivory Classic | V2 Variation
18" x 18"



Valencia | V4 Variation
18" x 18"



Silver | V4 Variation
18" x 18", 12" x 24"



Umbria Savera | V4 Variation
18" x 18"



Pendio Beige | V4 Variation
24" x 24", 18" x 18", 12" x 24"

Sizes



24" x 24"



18" x 18"



12" x 24"

Testing

Shade Variation
Rating

Results*

VARIES BY COLOR

*For more information visit www.emser.com. Always consult a professional for proper usage and installation.

FLOOR / WALL 

RESIDENTIAL 

COMMERCIAL 

INDOOR 



Silver

Sizes



12" x 24"

Testing

Shade Variation
Rating

Results* V4

FLOOR / WALL



RESIDENTIAL



COMMERCIAL



INDOOR



Presidio Ivory
12"x24"



Presidio Ivory Striated & Chiseled
12"x24"



Champagne Light Striated & Chiseled
12"x24"



Presidio Ivory Chevron
12"x12" Mesh



Presidio Ivory Rhombus
12"x12" Mesh



Presidio Ivory Pattern
6"x24" on Mesh



Presidio Ivory Splitface
6"x24" on Mesh

Sizes



12"x24"

Testing

Shade Variation
Rating

Results* V2

*For more information visit www.emser.com. Always consult a professional for proper usage and installation.

Limestone contains subtle variations in color and veining as a result of minerals that are present during formation. The naturally occurring variations add to the beauty of the stone.

LIMESTONE

Limestone



FLOOR / WALL



RESIDENTIAL



COMMERCIAL



INDOOR



OUTDOOR

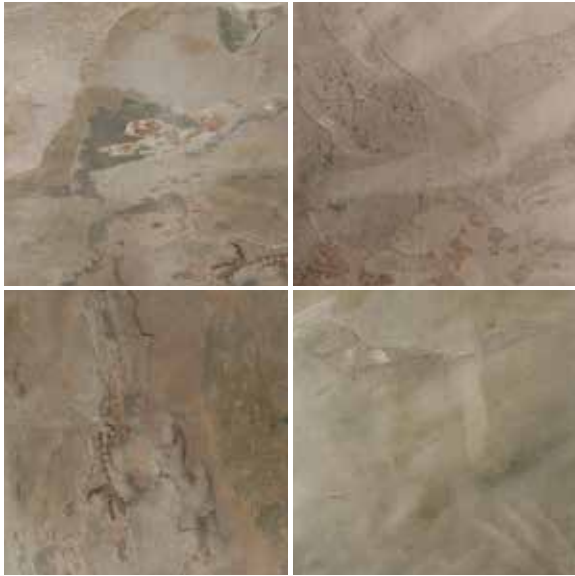

Autumn Lilac | V4 Variation
16"x16"

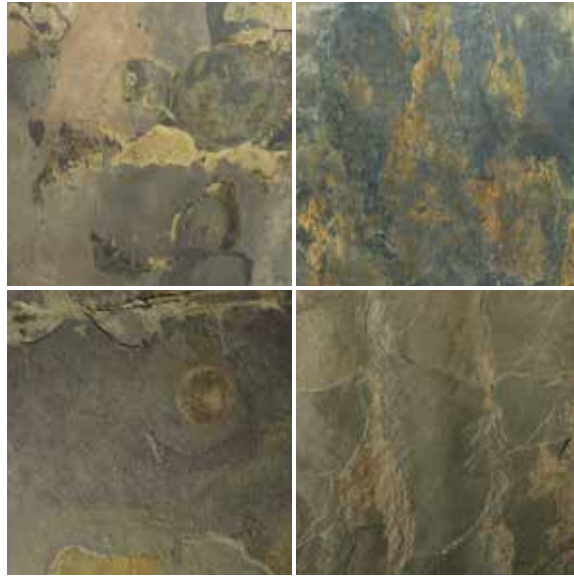

Rustic Gold | V4 Variation
16"x16", 12"x12"



Multi Rajah | V4 Variation
16"x16", 12"x12"

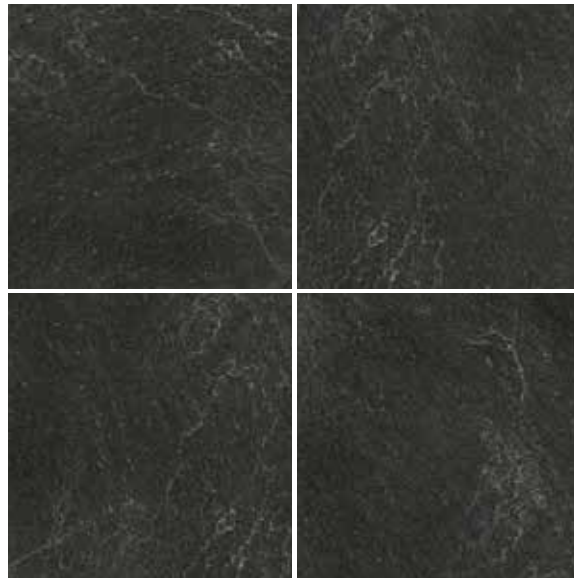

Midnight Black | V3 Variation
16"x16"

Sizes



16"x16"



12"x12"

Testing

Shade Variation
Rating

Results*

VARIES BY COLOR

*For more information visit www.emser.com. Always consult a professional for proper usage and installation.

With its natural variation in color and striking layered texture, Slate creates a unique showpiece in any environment.

SLATE, QUARTZITE, & SANDSTONE

Slate & Quartzite



Mini Stacked



Black Quartzite



White Quartzite



Cream Gold Quartzite | Flamed



Corner Piece Available in All Colors*

Stacked



Autumn Lilac



Black Quartzite



Rustic Gold | California Gold



Cream Gold Quartzite | Flamed



White Quartzite



Corner Piece Available in All Colors*

*Corner sets are interlocking two-piece sets that make up each corner. The dovetail jointed ends with the chiseled/natural edge interlock at the apex, and the straight cut edges on the opposing sides will line up to the corresponding 6x24 piece. Product is produced from natural stone and therefore will vary in thickness ranging from 3/8" to 1".

Testing Shade Variation Rating

Results* V4

SLATE, QUARTZITE, & SANDSTONE

Slate & Quartzite



Borgo Pattern

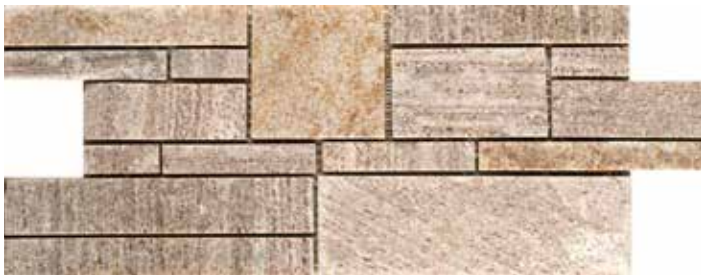

Cream Gold Quartzite | Flamed

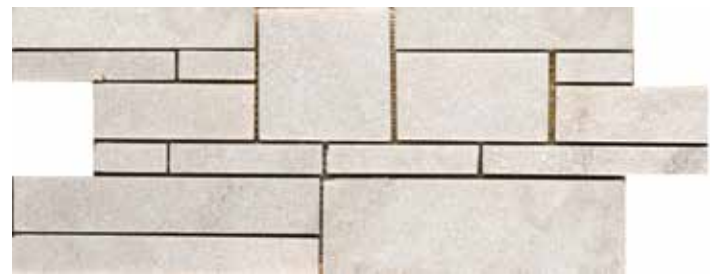

White Quartzite

Borgo Pattern Colors Available in Calibrated/Gauged 6.75"x17.5" Mesh



Slate White Striated & Chiseled
12"x24"



Ivory Stacked Ledger



Ivory 3D Ledger



Beige Stacked Ledger



Beige 3D Ledger



Sand Stacked Ledger



Sand 3D Ledger



Cream Stacked Ledger



Cream 3D Ledger



Blue Stacked Ledger



Blue 3D Ledger



Gray Stacked Ledger



Gray 3D Ledger

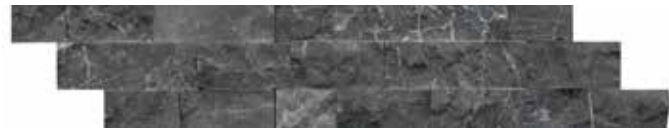

Charcoal Stacked Ledger

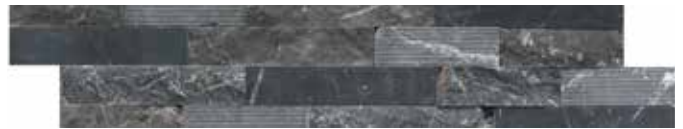

Charcoal 3D Ledger

Sizes

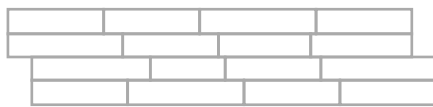

6"x24" Mesh

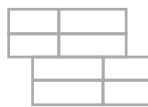

Corner Set

Testing

Shade Variation Rating

Results* V4

*For more information visit www.emser.com. Always consult a professional for proper usage and installation.

With a natural variation and an impressive mix of stones, Structure™ offers multiple colors in 3D and stacked ledgers. The blend of texture in the 3D ledger is sure to make a lasting impression.

STRUCTURE™

Stone Ledger





FLOOR / WALL  RESIDENTIAL  COMMERCIAL  INDOOR  OUTDOOR 



Galaxy Black
12"x12"



Absolute Black
12"x24", 12"x12"

Sizes		
	12"x24"	12"x12"
Testing	Shade Variation Rating	
Results*	VI	

*For more information visit www.emser.com. Always consult a professional for proper usage and installation.

Visually striking, granite is a popular choice for countertops and floors due to its high durability and aesthetic qualities.

GRANITE

Polished Granite



FLOOR / WALL  RESIDENTIAL  COMMERCIAL  INDOOR  OUTDOOR 



Beige



Brick



Smoke



Beige Abrasive



Brick Abrasive

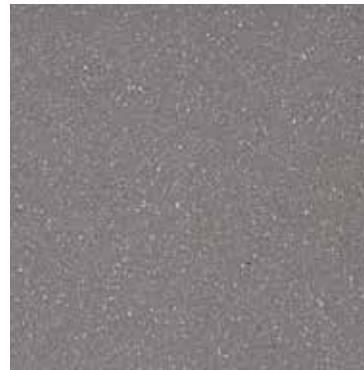

Smoke Abrasive

Recommended Maintenance

Sweep, vacuum or damp mop as necessary to remove dust, dirt and grit. Remove heavy spills or spots immediately with a heavy detergent and stiff brush or a non-metallic scouring pad. Routinely mop the surface with a neutral liquid cleaner. Use a simple two bucket method-one bucket containing the diluted cleaner and the other containing clear water. Mop in small areas and change the rinse water regularly. Mop up any dirty cleaning solution and allow the floor to dry thoroughly. Under normal conditions, rinsing is not necessary. However, if the surface is extremely dirty, it should be allowed to dry and mopped again. Over time a natural patina will develop. It can be enhanced with a soft buffing. For applications in restaurants/cafeteria service and dining areas, at least once per week - and more often if necessary - the floor should be scrubbed with a solution of all-purpose cleaner and a scrub brush.

Cleaning and Maintenance: Initial Cleaning and Seasoning

It is the installer's responsibility to thoroughly clean and remove all grout or mortar from the new tile surface. Because grout joints are porous and highly susceptible to staining, you may wish to protect them with an application of a penetrating sealer. If the floor will be subject to frequent staining by fat, oil or grease, you may wish to apply the penetrating sealer to the tile as well. Follow the manufacturer's directions carefully. Seal the floor only after it is thoroughly cleaned and before seasoning the floor. Season the floor by mopping thoroughly with a double strength application of neutral liquid cleaner.



Abrasive Finish

- High Breaking Strength - TCNA Approved
- Slip & Frost Resistant
- Not Affected By Chemicals & Oils
- Easy & Economical Installation
- Approved For Outdoor Installations
- Lighter & Lower Freight
- Glazed and Unglazed Quarry Brick Sizes
- Additional Field Tile 12"x12" and Trims available via special order (stair treads, pool copings)
- Industrial Floors Available for Industrial Projects (food processing, beverage and/or packing plants)

Sizes	6"x6"	6"x6" Cove Base	6"x6" Cove Base Corner In	6"x6" Cove Base Corner Out (Left/Right)			
Thickness	9mm	9.5mm	9.5mm	9.5mm			
Faces	N/A	N/A	N/A	N/A			
Finish	Matte	Matte	Matte	Matte			
Edge	Pressed	Pressed	Pressed	Pressed			
Grout Joint Recommendation	3/8"	3/8"	3/8"	3/8"			
Testing	Abrasion Resistance C1027	Breaking Strength C648	Chemical Resistance C650	Water Absorption C373	DCOF ANSI A1371	Scratch Hardness MOHS	Shade Variation Rating
Results*	1	≥400 lbf	Resistant	<0.25%	>0.70	8	V1

Sustainability Attributes

- Red List Free
- Health Product Declaration (HPD) provided upon request
- Product Packaging is 100% recyclable

*For more information visit www.emser.com. Always consult a professional for proper usage and installation.



Unglazed quarry tile is the perfect answer for installations that need added durability and slip resistance. Its extruded/die skin body resists breaking, and the relieved edges resist chipping. For an even higher level of slip resistance, an abrasive surface product is available.

E-QUARRY

Unglazed Quarry

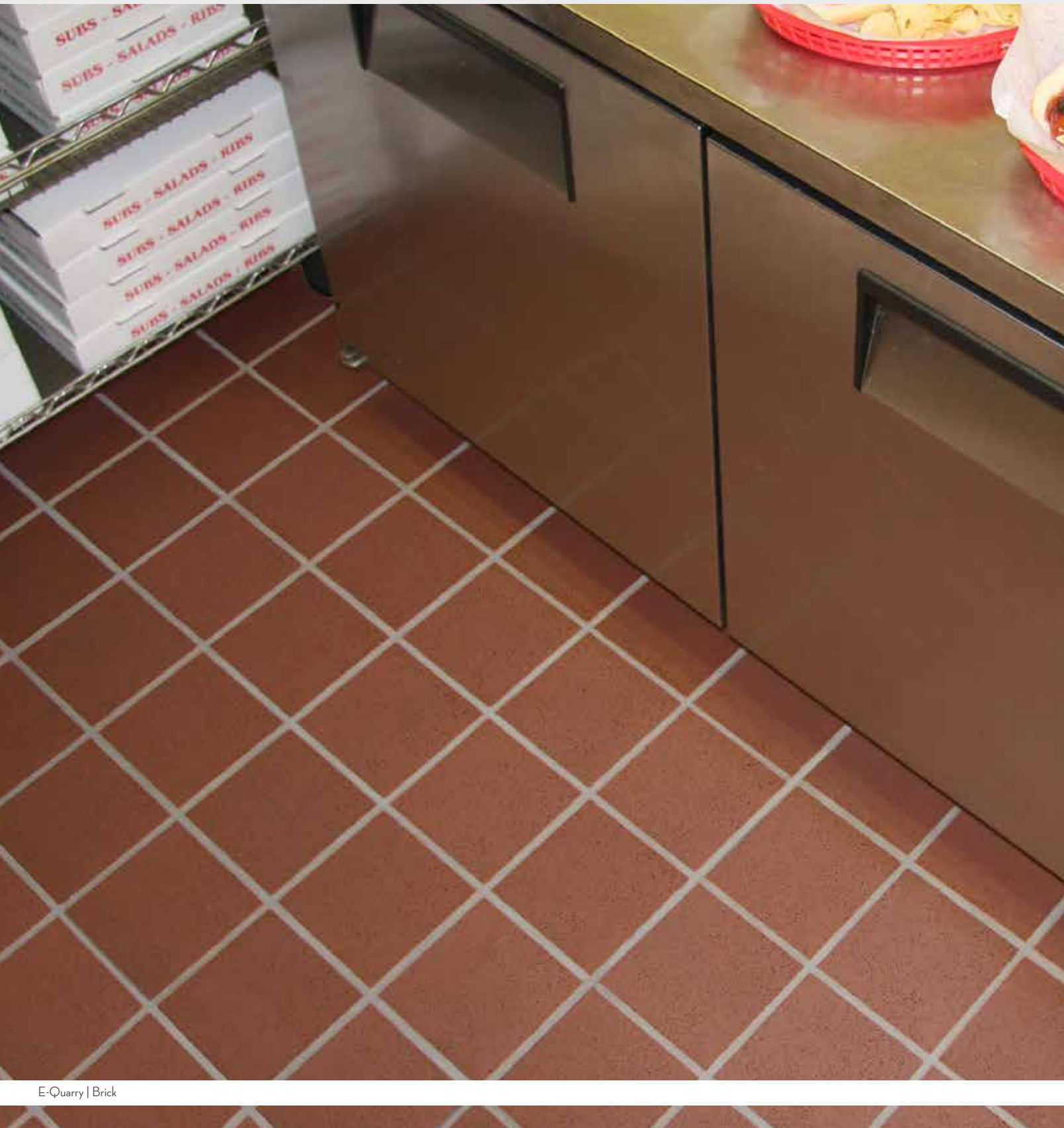



Banzai™ • Fervor 6 x 35"



RESOURCES

PRODUCT TESTING & ATTRIBUTES

In order for a tile to be considered for a particular application, various test results must be considered in addition to defining its final use. Usage charts are provided as a general guide only. Actual job site conditions may change a product's suitability for a specific application. If special conditions apply; an Emser Tile® representative should be consulted prior to material selections. All testing is conducted in a lab environment and represents the specific specimens being tested. New production runs, actual jobsite conditions, as well as the handling and installation of products may alter the performance results. For the most current testing results and application usage guide please visit our website at emser.com. The testing and information that should be looked at prior to making selections are as follows:

Water Absorption - ASTM C373

Water absorption is the measurement of density, porosity and specific gravity of a product. It is used as a tool for identifying structural properties of the body of the tile that may be required to determine use in a given application. Tiles are classified according to water absorption percentages as follows:

Impervious tile:	<0.5%
Vitreous tile:	>0.5% - ≤3%
Semi-vitreous tile:	>3% - <7%
Non-vitreous:	>7% - <20%

Breaking Strength - ASTM C648

Breaking strength is measured by applying force to an unsupported portion of tile until breakage occurs. The results are expressed in lbf (pounds of force). This test covers the determination of the breaking strength of glazed and unglazed porcelain and ceramic floor tiles, wall tiles, mosaics, quarry tiles, and paver tiles. Ceramic/ Porcelain tiles used on floors and walls must be able to withstand the expected load bearing capacity of various installations and must meet >250lbf to be considered suitable for floor use. This is a very different measurement of force than PSI and there is no direct conversion of pounds of force to pounds per square inch.

Chemical Resistance - ASTM C650

The chemical resistance test is intended for tile that will be used for lavatories, food counters or similar residential, commercial or medical installations. A tile sample is placed in continuous contact with a variety of chemicals for 24 hours, rinsing the surface and then examining the surface for visible variation. These results are typically measured as a pass or fail.

Freeze Thaw Cycling - ASTM C1026

The freeze thaw cycle test measures a tile's resistance to various stages of freeze cycles. The first step involves soaking the tile in water using a vacuum method to ensure its pores are properly saturated before it is subjected to freezing temperatures. The tile is then monitored for failures. As water expands when it freezes, tiles that are not suitable will show stress cracks, or simply break apart. These results are typically reported as a pass or fail.

Scratch Hardness - MOHS Scale

Scratch hardness is the tile surface resistance to scratching by different minerals, the softest being talc (1) and the hardest being diamond (10). The MOHS scale of hardness is the most common method used to rank gemstones and minerals according to hardness.

Abrasion Resistance - ASTM C1027

Abrasion resistance measures the visible surface abrasion of glazed porcelain and ceramic, glazed quarry, and glazed mosaics by subjecting the test specimens to a rotating abrasion wheel. This test is monitored for failures after a certain number of cycles. Below is the classification for this test:

- O: Wall use only- 100 rotations
- I: Residential, light traffic- 150 rotations
- II: Residential, medium to light traffic- 600 rotations
- III: Residential, heavy traffic; Commercial, light traffic- 750-1,500 rotations
- IV: Commercial, considerable traffic- 2,100-12,000 rotations
- V: Commercial, heavy traffic- >12,000 rotations plus dye test

*Deep Abrasion ASTM C1243 must be used for unglazed products

Deep Abrasion Resistance - ASTM C1243

Deep Abrasion resistance measures the volume removed from an unglazed tile that is subjected to a rotating abrasion wheel. Below is the classification for this test:

- Class 1:** Pressed, extruded, other with <0.50% water absorption - maximum loss 175mm³
- Class 2:** Pressed with >0.50%-3.0% water absorption - maximum loss 225mm³
- Class 2:** Extruded, other with >0.50%-3.0% water absorption - maximum loss 275mm³
- Class 3:** Pressed with >3.00%- 7.00% water absorption - maximum loss 345mm³
- Class 3:** Extruded, other with >3.00%- 7.00% water absorption - maximum loss 393mm³
- Class 4:** Extruded, other with >7.00%-20.00% water absorption - maximum loss 2,365mm³
- Class 4:** Pressed with >7.00%-20.00% water absorption - maximum loss no requirement

Dynamic Coefficient of Friction - ANSI A137.1 and A326.3

The coefficient of friction measurement is an evaluation of a tile surface under known conditions using a standardized sensor material. It provides a useful comparison of tile surfaces, but it does not predict the likelihood a person will or will not slip on a tile surface. DCOF (Dynamic Coefficient of Friction) specifically tests the friction of an object that is already in motion (kinetic). The BOT3000E (Binary Output Tribometer) is a machine that runs approximately 8" across a surface, measures the DCOF of the tile and provides a digital reading with the results. Because this machine is automated, it objectively measures the slip resistance and most importantly provides

repeatable results. ANSI A137.1 recommends, but does not require, a wet result of 0.42 or greater for interior surfaces that are intended to be walked on wet. If the surface is not intended to be walked on wet then a different value may be specified. Some surfaces intended to be walked on wet should be >0.60 depending on final traffic type and use, so specification of “>0.42” may not be sufficient. Although there are no ADA or OSHA benchmarks for DCOF values in the current guidelines and codes for interior applications, Emser recommends a DCOF of 0.50 or greater for covered exterior floor applications as well as interior commercial dining areas due to the presence of grease, water and other contaminants. Emser also recommends that all exposed exterior floors that will be walked on wet meet 0.60 DCOF. If the floors will not be walked on when wet then a lower DCOF may be suitable. There is no direct conversion of ANSI DCOF values to European ISO R-values, however a comparison range can be provided by request.

Shade Variation

Shade variation is the tile’s range from complete inconsistency to a more random appearance. Below is an overview of color and shading of individual tile selections.

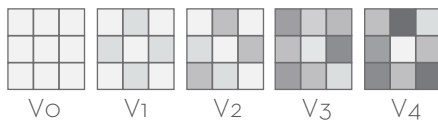

- V0** - Monochromatic - Very uniform, monochromatic color
- V1** - Low - Consistent color within each tile and from tile to tile
- V2** - Medium - Color variation within each tile
- V3** - High - Some variation from tile to tile, and within each tile
- V4** - Random - Considerable variation from tile to tile

Glazed Porcelain

Glazed porcelains are manufactured to have superior breaking strength, scratch, wear, dirt and water resistance. Porcelains are a type of ceramic with a much more refined body and are dry pressed. The body of a porcelain has a <0.50% water absorption rate while the glaze applied to the surface of the tile is impermeable. All porcelain tiles are fired in a kiln just like ceramics but they are fired under higher heat for longer periods of time, and under pressure, which adds to the density and durability of the tile.

Glazed Ceramic

Glazed ceramics offer stain and moisture resistance compared to most unglazed clay products. Ceramic tiles are made from a combination of clays, polymers and fine powders such as sand and feldspar. The body of a ceramic is often referred to as a “bisque,” or “clay.” Ceramics have either a red or white body, which is typically determined by the region the clay was mined from. The body of a ceramic has a >0.50% water absorption rate, while the glaze applied to the surface of the tile is impermeable after firing, making it a low maintenance and durable wall or flooring surface.

Glazed Body Match

Glazed products typically have a white or red body, however, a glazed body match tile has a tinted body to match the top glaze color. With glazed porcelain and ceramic tiles, the hardness and abrasion resistance of the glaze will determine product suitability for a particular application. A colored body is more desirable in case the tile chips or scratches and the color of the body becomes exposed. If the body matches the glaze, chips and scratches will not be as evident.

Through-Body/Unglazed

Through-body porcelains are unglazed and exhibit the same color and pattern all the way through the tile. The pressed dry powder method is also known as Single Charging. During this process, fine powders are colored during the pressing stage of production and the pigments are consistent throughout the body of the tile. Through-body porcelain tiles are typically very dense, extremely durable and desirable in applications subject to heavy abrasion. The advantage to using through body products is the ability to bullnose custom trims on site and ability to buff out any light scratching.

Double Loaded

Double Loaded, also known as Double Charging, is formed by fusing two layers of porcelain together. The base layer of porcelain is bonded to an aesthetic top layer where the coloring is already infused into the micro-powders. Once these two layers are pressed together, they are fired to form one solid tile. No glaze is applied to the top surface. These tiles can often be bullnosed just like a through-body as the top and bottom layers are similar in color. The thickness of the top layer is significant enough where the performance characteristics would be the same as a through-body tile.

PRODUCT DETAILS CHART

Emser Tile® Part Numbers Examples:

Prefix	Color Code	Size/Finish
F13STER	AS	1224P
Sterlina	Asphalt	12x24 Polished

Prefix	Color Code	Size/Type/Finish
F13STER	AS	1212MOM
Sterlina	Asphalt	12x12 Mosaic Matte

Prefix	NCS ID	Size/Finish/Version
Jo1BW	S7020R90B	o3o6PV2
B2B Wall	S7020-R90B	3x6 Glossy

Floor Tile

Series	Part No. Prefix	Sizes	Edge	Finish	Faces
Access II	F23ACCE	12x24 24x47	Rectified	Matte	16
			Rectified	Matte	4
Action	F45ACTI	11x23	Rectified	Polished	24
Albero	F58ALBE	8x24	Pressed	Matte	8
Angeles	F34ANGE	9x47	Pressed	Matte	18
Anthem	F58ANTH	18x18 13x23 12x12	Pressed	Matte	8
			Pressed	Matte	8
			Pressed	Matte	8
Archive	Fo2ARCH	11x23	Rectified	Polished	16
Baja	F22BAJA	18x18 14x14 13x13 12x24 6x6	Pressed	Matte	5
			Pressed	Matte	4
			Pressed	Matte	4
			Pressed	Matte	8
			Pressed	Matte	16
Banzai	Fo7BANZ	6x35	Pressed	Matte	10
Bauhaus	W34BAUH	8x8 Plain Hex Arrow Floral	Rectified	Matte	10
			Pressed	Matte	10
			Pressed	Matte	10
			Pressed	Matte	15
Beach Wood	F59BEAW	8x34	Rectified	Matte	20
Beckway	Fo2BECK	6x24	Pressed	Matte	9
Belstar	F22BELS	16x16	Pressed	Matte	9
Borgata	F22BORG	12x24 16x16	Pressed	Matte	8
			Pressed	Matte	12
Borigni	A41BORI	12x23 18x35 35x35	Rectified	Matte	20
			Rectified	Matte	20
			Rectified	Matte	10
Brava	F39BRAV	13x13 12x24	Pressed	Matte	17
			Pressed	Matte	11
Brique	F39BRIQ	2x10	Pressed	Matte	24
Brook	F22BROO	18x18 14x14 12x24	Pressed	Matte	12
			Pressed	Matte	24
			Pressed	Matte	16
BB Concrete	Jo1BCON	12x24 15x29 24x47 29x29	Rectified	Matte	32
			Rectified	Matte	32
			Rectified	Matte	8
			Rectified	Matte	16
BB Metal	Jo1BMET	12x24 24x47	Rectified	Matte	48
			Rectified	Matte	12
BB Wood Oak	Jo1BOAK	8x47	Rectified	Matte	40

Series	Part No. Prefix	Sizes	Edge	Finish	Faces
BB Wood Yakedo	F42YAKE	8x47	Rectified	Matte	36
			Rectified	Matte	36
Cabin	F12CABI	6x24	Pressed	Matte	6
Cabo	F84CABO	13x13 17x17	Pressed	Matte	20
			Pressed	Matte	20
Cassero II	F23CASS	12x24 24x47	Rectified	Matte	16
			Rectified	Matte	4
Chiado II	Fo4CHIA	12x24	Rectified	Matte	12
Chronicle	Fo2CHRO	12x24	Pressed	Matte	16
Citizen	F26CITI	12x24 24x24 24x48	Rectified	Matte & Lappato	30
			Rectified		15
			Rectified		12
Ciudad	F84CIUD	12x24	Pressed	Matte	12
Contessa	F15CONT	3x6 3x6 11x23 12x24 13x13 18x18 23x23 24x24	Rectified	Matte	>100
			Rectified	Polished	>100
			Rectified	Polished	20
			Pressed	Matte	20
			Pressed	Matte	10
			Pressed	Matte	9
			Rectified	Polished	10
Pressed	Matte	10			
Cortijo	F26CORT	18x18	Pressed	Matte	8
Cosmopolitan	Fo2COSM	12x24 24x24	Pressed	Matte	10
			Pressed	Matte	5
Council	F5oCOUN	12x24 24x24	Rectified	Matte	12
			Rectified	Matte	6
Daroca	F16DARO	12x24 13x13 17x17	Pressed	Matte	20
			Pressed	Matte	20
			Pressed	Matte	20
Denova	F47DENO	9x36 12x24	Pressed	Matte	12
			Pressed	Matte	12
Design Design (Art)	F37DESI	9x9 9x9	Pressed	Matte	1
			Pressed	Matte	18
Dunham	F45DUNH	12x23	Rectified	Matte	18
Erosion	F13EROS	12x24 13x13 20x20	Pressed	Matte	16
			Pressed	Matte	20
			Pressed	Matte	16
Esplanade	Fo2ESPL	11x23 12x24 17x35	Rectified	Polished	16
			Pressed	Matte	16
			Pressed	Matte	5
Eurasia	Fo2EURA	12x24	Pressed	Matte	8

Series	Part No. Prefix	Sizes	Edge	Finish	Faces
Expanse:					
Arabescato	V68EXPA	63x126	Rectified	Polished	3
Lazio White	V68EXPA	63x126	Rectified	Polished	3
Onix White	V68EXPA	63x126	Rectified	Polished	4
Network	V40NETW	63x126	Rectified	Matte	3
Hangar	V40HANG	63x126	Rectified	Matte	2
Explorer	F07EXPL	12x24	Pressed	Matte	18
Facade	F45FACA	12x24	Pressed	Matte	18
Geometry	F39GEOM	10x10	Pressed	Matte	1
Giza	F15GIZA	12x24	Pressed	Matte	10
Hangar	A40HANG	12x23 23x47	Rectified Rectified	Matte Matte	20 10
Havana	F58HAVA	12x12 18x18	Pressed Pressed	Matte Matte	8 8
Heksa	F30HEKS	8x9	Pressed	Matte	1
Hollywood	A40HOLL	8x47	Rectified	Matte	8
Ironworx	F82IRON	12x23 Ridge 31x31	Rectified Rectified Rectified	Matte Matte Matte	72 36 18
Larchmont	F12LARC	6x35 6x24	Pressed Pressed	Matte Matte	9 9
Latitude	F45LATI	12x24	Pressed	Matte	24
Legacy	A40LEGA	8x47	Rectified	Matte	20
Livorno	A40LIVO	12x23 23x47	Rectified Rectified	Matte Matte	8 8
Milestone	F86MILE	12x24 24x47	Rectified Rectified	Matte Matte	20-24 5
Mokuzai II	F15MOKU	8x35	Pressed	Matte	9
Mood	F44MOOD	12x23 23x47	Rectified Rectified	Matte Matte	84 21
Motion	F45MOTI	12x24	Pressed	Matte	24
Network	A40NETW	12x23 23x47 31x31	Rectified Rectified Rectified	Matte Matte Matte	30 10 24
Newport	F17NEWP	12x24 12x24	Rectified Rectified	Matte Lappato	16 16
Nostalgia	F26NOST	18x18	Pressed	Matte	4
Nova	F49NOVA	12x24	Pressed	Matte	18
Orchard	F23ORCH	8x47	Rectified	Matte	10
Outpost	A86OUTP	12x24 24x47	Rectified Rectified	Matte Matte	32 8
Parkview	A86PARK	12x24 12x24 24x47	Rectified Rectified Rectified	Matte Polished Polished	32-36 32-36 8-9
Pienza	F39PIEN	12x24 24x24	Pressed Pressed	Matte Matte	11 8
Pocono	F19POCO	6x24 6x36	Pressed Pressed	Matte Matte	20 20
Porch	F33PORC	6x47 8x47 12x47	Rectified Rectified Rectified	Matte Matte Matte	40 30 20
Porto II	F16PORT	12x24 24x24 32x32	Rectified Rectified Rectified	Matte & Polihsed	10 8 8

Series	Part No. Prefix	Sizes	Edge	Finish	Faces
Potenza	F12POTE	12x24 13x13 18x18	Pressed Pressed Pressed	Matte Matte Matte	9 13 7
Realm II	F02REAL	12x24 13x13 18x18	Pressed Pressed Pressed	Matte Matte Matte	10 11 11
Reminisce	F26REMI	18x18	Pressed	Matte	1
Rerserva	F02RESE	12x24 13x13 18x18	Pressed Pressed Pressed	Matte Matte Matte	37 49 37
Rhapsody	F36RHAP	13x13	Pressed	Matte	20
Rhythm	F36RHYT	11x13	Pressed	Matte	Solid
Sanctuary II	F47SANC	9x36	Pressed	Matte	6
Sandstorm	F02SAND	12x24	Pressed	Matte	16
Sculpture	F26SCUL	12x24	Pressed	Matte	26
Señora	F26SENO	18x18	Pressed	Matte	10
Serendra	F07SERE	12x24 12x24 24x47 24x47 31x31 31x31	Pressed Pressed Pressed Pressed Pressed Pressed	Matte Polished Matte Polished Matte Polished	12 12 4 4 4 4
Silhouette	F02SILH	12x24	Pressed	Matte	6
Sterlina	F13STER	6x12 9x10 Hex 12x24 12x24 24x24 24x24 24x47 24x47	Rectified TIP Rectified Rectified Rectified Rectified Rectified Rectified	Polished Matte Matte Polished Matte Polished Matte Polished	12 TIP 12 12 12 12 6 6
Style II	F04STYL	12x24 12x24 24x24 24x24 24x47 24x47 32x32	Rectified Rectified Rectified Rectified Rectified Rectified Rectified	Matte Polished Matte Polished Matte Polished Polished	1 1 1 1 1 1 1
Sweden	F65SWED	12x24 24x24	Rectified Rectified	Polished Polished	20 6
Swiss II	F67SWIS	11x23 12x23 24x47 32x32	Rectified Rectified Rectified Rectified	Polished Matte Polished Polished	20 20 20 20
Technique	F16TECH	12x24	Pressed	Matte	16
Terazio	F43TERA	12x24 24x24	Rectified Pressed	Matte Polished	16 8
Tesola	F58TESO	12x12 18x18	Pressed Pressed	Matte Matte	8 8
Theory	F23THEO	8x45	Rectified	Matte	12
Thread II	F04THRE	12x24	Rectified	Matte	1
Toledo	F84TOLE	13x13 17x17	Pressed Pressed	Matte Matte	4 4
Trendz	F48TREN	12x24 12x35	Rectified Rectified	Matte Matte	32 8

PRODUCT DETAILS CHART (CONT.)

Floor Tile (CONT.)

Series	Part No. Prefix	Sizes	Edge	Finish	Faces
Trovata II	F50TROV	12x24	Pressed	Matte	16
		13x13	Pressed	Matte	16
		21x21	Pressed	Matte	8
Uddo	F58UDDO	8x24	Pressed	Matte	8
Uptown	A86UPTO	12x24	Rectified	Matte	24
		24x24	Rectified	Matte	20
		24x47	Rectified	Matte	6
Vara	Vo4VARA	12x24	Rectified	Matte	12-17
		12x24	Rectified	Polished	12-17
		24x24	Rectified	Matte	10
		24x24	Rectified	Polished	10
		24x47	Rectified	Matte	6
		24x47	Rectified	Polished	6
Velocity	Fo2VELO	17x35	Rectified	Matte	3
Victus	Fo7VICT	8x48	Pressed	Matte	16
Virtue	F19VIRT	18x18	Pressed	Matte	4
Xtra Cemento Xtra Travertine	B11XTRA	24x24	Rectified	Matte	8
		24x24	Rectified	Matte	12

Wall Tile

Series	Part No. Prefix	Sizes	Edge	Finish	Faces/ Patterns
Artwork	F33ARTW	12x35	Pressed	Glossy	1 / 3
Back to Basics	Jo1BWS	3x6	Pressed	Glossy	1 / 1
Bimova	F14BIMO	8x24	Pressed	Glossy	10-12 / 1
Catch	F14CATC	2x8	Pressed	Matte & Glossy	1 / 1
		3x6	Pressed		
		3x12	Pressed		
		4x10	Pressed		
		4x16	Pressed		
		6x18	Pressed		
		6x6	Pressed	Glossy	Ice Only
Center	F26CENT	13x36	Rectified	Matte	1 / 3
Choice II	F28CHOI	3x6	Pressed	Glossy	1 / 1
		4x12			
Code	W10COD F10CODE	Hex	Pressed	Matte	1 / 3
		Trap.	Pressed	Matte	1 / 1
Colori	F26COLO	10x30	Pressed	Glossy	1 / 1
Connect	Wo6CONN	6x24	Pressed	Matte	215
Craft II	F46CRAF	3x12	Pressed	Matte & Glossy	1 / 1
Emora	F14EMOR	3x6	Pressed	Matte & Glossy	18-64 / 1 18-64 / 1
		4x16	Pressed		
Euphoria	W30EUPH	3x12	Pressed	Matte	1 / 3
Express	W37EXPR	3x12	Pressed	Glossy	1 / 4

Series	Part No. Prefix	Sizes	Edge	Finish	Faces/ Patterns
Fregio	W20FREG	6x20	Straight	Matte	3 / 2
Glow	W86GLOW	17x47	Rectified	Matte	1 / 3
Hues	W21HUES	3x10	Rectified	Matte	1 / 1
Immerse	F25IMME	6x6	Pressed	Glossy	12 / 1
Jazz	W53JAZZ	12x24	Rectified	Glossy	1 / 2
Kudos	F23KUDO	12x24	Rectified	Matte & Polished	32 / 1
	W23KUDO	16x47		Polished	16 / 2
Luxo	W24LUXO	3x12	Pressed	Glossy	1 / 1
Marquesa	W35MARQ	16x47	Rectified	Matte	11 / 2
Motif II	W46MOTI	4x12	Pressed	Glossy	1 / 1
Nuovo	W38NUOV	12x35	Rectified	Matte	1 / 5
Ombre	W37OMBR	6x12	Pressed	Glossy	4 / 1
Passion	W32PASS	3x8	Pressed	Glossy	30 / 1
		9x9		Glossy	30 / 1
Place2B	W10PLAC	2x10	Pressed	Matte	8 / 1
Raku	W32RAKU	3x12	Pressed	Matte & Glossy	56 / 1
Rift	W35RIFT	16x47	Rectified	Matte	3 / 1
				Glossy	
Sculpture	F26SCUL	12x24	Pressed	Matte	26 / 1
		13x36		Glossy	16 / 3
Sonata	W35SONA	16x47	Rectified	Matte	2 / 1
Sparkle	W35SPAR	12x39	Rectified	Matte	1-6 / 5
Sphere	W23SPHE	3x12	Pressed	Glossy	1 / 1
Synergy	W61SYNE	16x47	Rectified	Matte	1-3 / 2
Vertigo	Fo2VERT	10x30	Pressed	Glossy	3 / 3

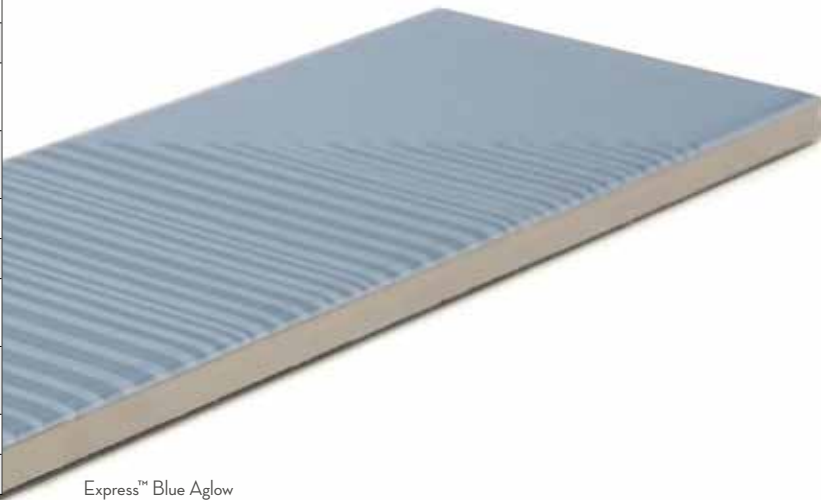

Express™ Blue Aglow

Decorative Tile

Series	Part No. Prefix	Sizes	Finish	Material
Afloat	F51AFLO	12x12 13x13	Glossy	Glazed Porcelain
Alluro	M05ALLU	9x9 12x12	Polished	Marble
Bizou	F67BIZO	9x13 10x12 12x13 13x13	Polished	Marble
Catalyst	W05CATA	13x14	Glossy/Matte	Resin Cast Stone & Glass
Charisma	W80CHAR	10x12 11x12 10x13	Glossy	Glass
Concept	W93CONC	8x10 8x12 10x12 11x12	Semi-Gloss	Glazed Glass
Confetti II	W85CON2	12x12	Glossy/Matte	Recycled Glass & Porcelain Mix
Cultura	M05CULT	12x12	Honed	Pebbles
Diva	W94DIVA	10x12	Glossy	Glazed Ceramic
Echo	W87ECHO	10x12 11x13 12x14	Glossy	Recycled Glass
Edge	W80EDGE	12x12	Glossy/Matte	Glass
Entity	W80ENTI	12x12	Glossy	Glass & Stone
Feature	P99FEAT	12x18	Splitface	Groutless Stone
Fleur	W94FLEU	11x12	Polished	Glazed Ceramic, Stone, & Glass
Glitz	W13GLIT	12x12	Glossy	Glass & Metal
H2O	W91H2O	12x12	Glossy	Glass
Hanami	W50HANA	9x13	Glossy	Glazed Porcelain
Illumina	W89ILLU	12x12	Glossy	Glass & Stone
Impact	F11IMPA	11x12 11x13 12x12 12x11	Matte	Glazed Porcelain
Impulse	W75IMPU	14x15	Polished/ Mirror	Marble, Limestone, & Antique Mirrored Glass
Infinity	W87INFI	12x12	Glossy	Glass
Influence	W95INFL	10x11 10x12 11x12 11x13	Glossy	Glazed Porcelain
Intrigue	W94INTR	11x15 12x12 12x14	Polished/ Matte/Mirror	Porcelain, Glass, & Stone
Irish	W91IRIS	8x11	Iridescent	Glass
Kaze	W50KAZE	12x16	Glossy/Matte	Glazed Ceramic
Kinetic	W50KINE	11x12	Glossy	Glazed Ceramic
Kumito	W50KUMI	12x16	Matte	Glazed Ceramic

Series	Part No. Prefix	Sizes	Finish	Material
La Vie	W13LAVI	12x12	Glossy	Glass
L'Amour	W83LAMO	9x11 10x11 10x12 12x12	Polished	Recycled Glass
Link	F67LINK	12x17 12x18	Polished	Groutless Marble
Literati	W05LITE	12x12	Glossy/ Honed/ Textured	Resin Cast Stone
Lucente	W80LUCE	12x12 12x13 13x13 3x6	Glossy/Matte	Glass
Mizu	W50MIZU	8x16	Glossy	Glazed Ceramic
Modan	W50MODA	12x12	Matte	Unglazed Porcelain
Morocco	W94MORO	10x11	Glossy	Glazed Ceramic
Mythos	W94MYTS	11x12 11x13 12x12	Matte	Glazed Ceramic
Nagara	W50NAGA	11x11	Glossy	Glazed Ceramic
Omni	W50OMNI	10x12	Glossy	Glazed Porcelain
Picket	W13PICK	10x11	Glossy	Glass
Retro II	W85RET2	9x10	Matte/Satin	Resin & Ceramic Mix
Reward	F27REWA	10x11 11x12	Glossy	Glazed Porcelain
Rezone	W95OZON	11x12 11x13	Matte	Unglazed Porcelain
Rivera Pebbles	M05PEBB	12x12	Honed	Flat Pebble
Source	W71SOUR	9x10 11x11 12x12	Matte	Unglazed Porcelain
Spin	W95SPIN	11x11	Matte	Glazed Porcelain
Splash	W88SPLA	10x10 10x14 11x12 12x13	Satin	Glass
Unique	W87UNIQ	12x12	Glossy/Matte	Glass & Stone
Venetian Pebbles	M18VENE	12x12	Honed	Flat Pebble
Volare	W94VOLA	12x12	Glossy/Matte	Glass & Porcelain
Waterlace	W29WATE	12x12	Glossy	Glass
Zen	W93ZEN	6x24	Glossy	Glass

PRODUCT USAGE CHART

Series	Commercial Floor	Residential Floor	Residential & Commercial Wall	Shower Wall	Shower Floor	Steam Shower	Kitchen Counter	Stove Area	Fireplace Façade	Exterior Wall	Exterior Floor (Covered)	Exterior Floor (Uncovered)	Pool Waterline	UV Stable
Access II	Y	Y	Y	Y	Y	Y	Y	Y	Y	Y	Y	N	Y	Y
Action	Y	Y	Y	Y	N	Y	Y	Y	Y	Y	N	N	Y	Y
Albero	N	Y	Y	N	N	N	N	Y	Y	N	N	N	N	Y
Alluro	TIP	Y	Y	TIP	TIP	TIP	TIP	TIP	TIP	TIP	TIP	TIP	TIP	TIP
Angeles	Y	Y	Y	Y	Y	Y	Y	Y	Y	Y	Y	Y	Y	Y
Anthem	N	Y	Y	Y	N	N	Y	Y	Y	N	N	N	N	Y
Archive	Y	Y	Y	Y	N	Y	Y	Y	Y	Y	N	N	Y	Y
Artwork	N	N	Y	Y	N	Y	N	Y	Y	N	N	N	N	Y
Back to Basics	N	N	Y	Y	N	N	N	Y	Y	N	N	N	N	Y
Baja	TIP	Y	Y	Y	TIP	N	N	N	Y	TIP	TIP	TIP	N	Y
Banzai	Y	Y	Y	Y	Y	Y	Y	Y	Y	Y	Y	Y	Y	Y
Bauhaus	Y	Y	Y	Y	Y	Y	Y	Y	Y	Y	Y	Y	Y	Y
Beach Wood	Y	Y	Y	Y	Y	Y	Y	Y	Y	Y	N	N	Y	Y
Beckway	Y	Y	Y	Y	Y	Y	Y	Y	Y	Y	Y	Y	Y	Y
Bizou	N	N	Y	Y	N	N	N	Y	Y	N	N	N	N	Y
Borigni	Y	Y	Y	Y	Y	Y	Y	Y	Y	Y	Y	N	Y	Y
Brava	Y	Y	Y	Y	Y	Y	Y	Y	Y	Y	Y	N	Y	Y
Brique	Y	Y	Y	Y	Y	Y	Y	Y	Y	Y	Y	Y	Y	Y
Brook	Y	Y	Y	Y	Y	N	Y	Y	Y	N	N	N	N	Y
Building Blocks™ Concrete	Y	Y	Y	Y	Y	Y	Y	Y	Y	Y	Y	Y	Y	Y
Building Blocks™ Metal	Y	Y	Y	Y	Y	Y	Y	Y	Y	Y	Y	Y	N	Y
Building Blocks™ Wood Oak	Y	Y	Y	Y	Y	Y	Y	Y	Y	Y	Y	N	Y	Y
Building Blocks™ Wood Yakedo	N	Y	Y	Y	Y	Y	Y	Y	Y	Y	Y	N	Y	Y
Cabin	Y	Y	Y	Y	Y	Y	Y	Y	Y	Y	Y	N	Y	Y
Cabo	N	Y	Y	Y	N	N	Y	Y	Y	N	N	N	N	Y
Cassero II	Y	Y	Y	Y	Y	Y	Y	Y	Y	Y	Y	Y	Y	Y
Catalyst	N	Y	Y	Y	Y	Y	N	N	Y	N	N	N	N	Y
Catch	N	N	Y	Y	N	N	N	Y	Y	N	N	N	N	Y
Center	N	N	Y	Y	N	N	N	Y	Y	N	N	N	N	Y
Charisma	N	N	Y	Y	N	Y	N	Y	Y	N	N	N	N	Y
Chiado II	Y	Y	Y	Y	Y	Y	Y	Y	Y	Y	Y	Y	Y	Y
Choice II	N	TIP	TIP	TIP	TIP	TIP	TIP	TIP	TIP	TIP	N	N	TIP	TIP
Chronicle	Y	Y	Y	Y	Y	Y	Y	Y	Y	Y	Y	Y	Y	Y
Citizen	Y	Y	Y	Y	Y	Y	Y	Y	Y	Y	Y	Y	Y	Y
Ciudad	Y	Y	Y	Y	Y	N	N	Y	Y	TIP	N	N	N	Y
Code Trapezoid	Y	Y	Y	Y	Y	Y	Y	Y	Y	Y	Y	Y	Y	Y
Colori	N	N	Y	Y	N	N	N	Y	Y	N	N	N	N	Y

Series	Commercial Floor	Residential Floor	Residential & Commercial Wall	Shower Wall	Shower Floor	Steam Shower	Kitchen Counter	Stove Area	Fireplace Façade	Exterior Wall	Exterior Floor (Covered)	Exterior Floor (Uncovered)	Pool Waterline	UV Stable
Concept	N	N	Y	Y	N	Y	N	Y	Y	Y	N	N	Y	Y
Confetti II (White/Freddo)	Y	Y	Y	Y	Y	Y	N	Y	Y	Y	Y	N	Y	Y
Confetti II (Bronze/Metal)	N	N	Y	Y	Y	Y	N	Y	Y	N	Y	N	N	Y
Connect	N	N	Y	Y	N	Y	N	Y	Y	Y	N	N	Y	Y
Contessa	Y	Y	Y	Y	Y	Y	Y	Y	Y	Y	Y	N	Y	Y
Cortijo	Y	Y	Y	Y	Y	N	Y	Y	Y	N	N	N	N	Y
Cosmopolitan	Y	Y	Y	Y	Y	Y	Y	Y	Y	Y	Y	Y	Y	Y
Council	Y	Y	Y	Y	Y	Y	Y	Y	Y	Y	Y	Y	Y	Y
Craft II	N	N	Y	Y	N	N	Y	Y	Y	N	N	N	N	Y
Cultura	Y	Y	Y	Y	Y	Y	Y	Y	Y	Y	Y	Y	Y	Y
Daroca	Y	Y	Y	Y	Y	Y	Y	Y	Y	Y	Y	N	Y	Y
Denova	Y	Y	Y	Y	Y	Y	Y	Y	Y	Y	Y	N	Y	Y
Design	Y	Y	Y	Y	Y	N	N	Y	Y	Y	Y	Y	N	Y
Diva	TIP	TIP	TIP	TIP	TIP	TIP	TIP	TIP	TIP	TIP	TIP	TIP	TIP	TIP
Dunham	Y	Y	Y	Y	Y	Y	Y	Y	Y	Y	N	N	Y	Y
Echo	N	Y	Y	Y	Y	Y	Y	Y	Y	Y	N	N	Y	Y
Edge	N	N	Y	Y	N	N	N	Y	Y	N	N	N	N	N
Emora	TIP	TIP	TIP	TIP	TIP	TIP	TIP	TIP	TIP	TIP	TIP	TIP	TIP	TIP
Entity	N	N	Y	Y	N	N	N	N	Y	N	N	N	N	N
Erosion	Y	Y	Y	Y	Y	Y	Y	Y	Y	Y	Y	Y	Y	Y
Esplanade	Y	Y	Y	Y	Y	Y	Y	Y	Y	Y	Y	Y	Y	Y
Euphoria	N	N	Y	Y	N	N	N	Y	N	N	N	N	N	Y
Eurasia	Y	Y	Y	Y	Y	Y	Y	Y	Y	Y	Y	N	Y	Y
Expanse	Y	Y	Y	Y	N	Y	Y	Y	Y	Y	N	N	Y	Y
Explorer	Y	Y	Y	Y	Y	Y	Y	Y	Y	Y	Y	Y	Y	Y
Express	N	N	Y	Y	N	N	N	Y	N	N	N	N	N	Y
Façade	Y	Y	Y	Y	Y	Y	Y	Y	Y	Y	N	N	Y	Y
Feature	TIP	TIP	TIP	TIP	TIP	TIP	TIP	TIP	TIP	TIP	TIP	TIP	TIP	TIP
Fleur	N	N	Y	Y	N	N	N	Y	Y	Y	N	N	Y	Y
Fregio (Flat)	Y	Y	Y	Y	Y	Y	Y	Y	Y	Y	N	N	Y	Y
Geometry	Y	Y	Y	Y	Y	Y	Y	Y	Y	Y	Y	N	Y	Y
Giza	Y	Y	Y	Y	Y	Y	Y	Y	Y	Y	Y	Y	Y	Y
Glitz	N	N	Y	N	N	N	N	Y	Y	N	N	N	N	N
Glow	N	N	Y	Y	N	N	N	Y	Y	Y	N	N	N	Y
H2O	N	N	Y	Y	N	Y	N	Y	Y	Y	N	N	Y	Y
Hanami	N	N	Y	Y	N	Y	N	TIP	TIP	Y	N	N	Y	Y
Hangar	Y	Y	Y	Y	Y	Y	Y	Y	Y	Y	N	N	Y	Y

PRODUCT USAGE CHART *(CONT.)*

Series	Commercial Floor	Residential Floor	Residential & Commercial Wall	Shower Wall	Shower Floor	Steam Shower	Kitchen Counter	Stove Area	Fireplace Façade	Exterior Wall	Exterior Floor (Covered)	Exterior Floor (Uncovered)	Pool Waterline	UV Stable
Havana	N	Y	Y	Y	N	N	Y	Y	Y	N	N	N	N	Y
Heksa	Y	Y	Y	Y	Y	Y	Y	Y	Y	Y	Y	Y	Y	Y
Hollywood	Y	Y	Y	Y	Y	Y	Y	Y	Y	Y	Y	Y	Y	Y
Hues	N	N	Y	Y	N	N	Y	Y	Y	N	N	N	N	Y
Illumina	N	N	Y	Y	N	N	N	Y	Y	N	N	N	N	Y
Immerse	N	N	Y	Y	N	Y	N	Y	Y	Y	N	N	Y	Y
Impact	Y	Y	Y	Y	Y	Y	N	Y	Y	Y	N	N	Y	Y
Impulse	TIP	N	TIP	Y	TIP	Y	N	Y	Y	TIP	TIP	TIP	Y	TIP
Infinity	N	N	Y	Y	N	N	N	Y	Y	N	N	N	N	Y
Influence	N	Y	Y	Y	Y	Y	N	Y	Y	Y	N	N	Y	Y
Intrigue	Y	Y	Y	Y	N	Y	Y	Y	Y	Y	N	N	Y	Y
Irish	N	N	Y	Y	N	Y	Y	Y	Y	Y	N	N	Y	Y
Ironworx Flat	Y	Y	Y	Y	Y	Y	Y	Y	Y	Y	Y	Y	Y	Y
Ironwork Ridge	N	Y	Y	Y	Y	Y	Y	Y	Y	Y	N	N	Y	Y
Jazz	N	N	Y	Y	N	Y	Y	Y	Y	N	N	N	N	Y
Kaze	N	N	Y	Y	N	Y	N	Y	Y	Y	N	N	Y	Y
Kinetic	N	N	Y	Y	N	Y	N	Y	Y	Y	N	N	Y	Y
Kudos (12x24 Matte)	Y	Y	Y	Y	Y	Y	Y	Y	Y	Y	Y	N	Y	Y
Kudos (12x24 Polished)	Y	Y	Y	Y	Y	Y	N	Y	Y	Y	Y	N	Y	Y
Kudos (16x47)	N	N	Y	Y	N	N	N	Y	Y	Y	N	N	N	Y
Kumito	N	N	Y	Y	N	Y	N	Y	Y	Y	N	N	Y	Y
L'Amour	N	N	Y	Y	N	Y	TIP	Y	Y	Y	N	N	Y	Y
La Vie	N	N	Y	Y	N	Y	Y	Y	Y	Y	N	N	Y	Y
Larchmont	Y	Y	Y	Y	Y	Y	Y	Y	Y	Y	Y	N	Y	Y
Latitude	Y	Y	Y	Y	Y	Y	Y	Y	Y	Y	Y	N	Y	Y
Legacy	Y	Y	Y	Y	Y	Y	Y	Y	Y	Y	Y	N	Y	Y
Link	Y	Y	Y	Y	Y	Y	N	Y	Y	Y	N	N	Y	Y
Literati	TIP	TIP	TIP	TIP	TIP	TIP	TIP	TIP	TIP	TIP	TIP	TIP	TIP	TIP
Livorno	Y	Y	Y	Y	Y	Y	TIP	Y	Y	Y	Y	Y	Y	Y
Lucente	N	N	Y	Y	Y	N	N	Y	Y	Y	N	N	Y	Y
Luxo	N	N	Y	Y	N	N	N	Y	Y	N	N	N	N	Y
Marquesa	N	N	Y	Y	N	N	N	Y	Y	N	N	N	N	Y
Milestone	Y	Y	Y	Y	Y	Y	Y	Y	Y	Y	Y	Y	Y	Y
Mizu	N	N	Y	Y	N	Y	N	Y	Y	Y	N	N	Y	Y
Modan	N	N	Y	Y	N	Y	Y	TIP	TIP	Y	N	N	Y	Y
Mokuzai II	Y	Y	Y	Y	Y	Y	Y	Y	Y	Y	Y	Y	Y	Y
Mood	Y	Y	Y	Y	Y	Y	Y	Y	Y	Y	Y	Y	Y	Y
Morocco	N	N	Y	Y	N	Y	Y	Y	Y	Y	N	N	Y	Y

PRODUCT USAGE CHART *(CONT.)*

Series	Commercial Floor	Residential Floor	Residential & Commercial Wall	Shower Wall	Shower Floor	Steam Shower	Kitchen Counter	Stove Area	Fireplace Façade	Exterior Wall	Exterior Floor (Covered)	Exterior Floor (Uncovered)	Pool Waterline	UV Stable
Sculpture (Flat)	Y	Y	Y	Y	Y	Y	Y	Y	Y	Y	Y	Y	Y	Y
Señora	Y	Y	Y	Y	Y	Y	N	Y	Y	Y	Y	Y	Y	Y
Serendra (Matte)	Y	Y	Y	Y	Y	Y	Y	Y	Y	Y	Y	N	Y	Y
Serendra (Polished)	Y	Y	Y	Y	Y	Y	Y	Y	Y	Y	Y	N	Y	Y
Silhouette	Y	Y	Y	Y	Y	Y	Y	Y	Y	Y	N	N	Y	Y
Sonata	TIP	TIP	TIP	TIP	TIP	TIP	TIP	TIP	TIP	TIP	TIP	TIP	TIP	TIP
Source	Y	Y	Y	Y	Y	Y	Y	Y	Y	Y	N	N	Y	Y
Sparkle	TIP	TIP	TIP	TIP	TIP	TIP	TIP	TIP	TIP	TIP	TIP	TIP	TIP	TIP
Sphere	N	N	Y	Y	N	N	N	Y	Y	N	N	N	N	Y
Spin	N	Y	Y	Y	Y	Y	N	Y	Y	Y	N	N	Y	Y
Splash	N	Y	Y	Y	N	Y	N	Y	Y	Y	N	TIP	Y	Y
Sterlina (Matte)	Y	Y	Y	Y	Y	Y	Y	Y	Y	Y	Y	Y	Y	Y
Sterlina (Polished)	Y	Y	Y	Y	Y	Y	N	Y	Y	Y	N	N	Y	N
Style II	Y	Y	Y	Y	Y	Y	Y	Y	Y	Y	Y	Y	Y	Y
Sweden (Polished)	Y	Y	Y	Y	Y	Y	N	Y	Y	Y	N	TIP	Y	Y
Swiss II	N	Y	Y	Y	N	Y	Y	Y	Y	Y	N	N	Y	Y
Synergy	N	N	Y	Y	N	N	N	Y	Y	N	N	N	N	Y
Technique	Y	Y	Y	Y	Y	Y	Y	Y	Y	Y	Y	Y	Y	Y
Terazio (Matte)	Y	Y	Y	Y	Y	Y	Y	Y	Y	Y	Y	N	Y	Y
Tesola	Y	Y	Y	Y	N	N	N	Y	Y	N	N	N	N	Y



Series	Commercial Floor	Residential Floor	Residential & Commercial Wall	Shower Wall	Shower Floor	Steam Shower	Kitchen Counter	Stove Area	Fireplace Façade	Exterior Wall	Exterior Floor (Covered)	Exterior Floor (Uncovered)	Pool Waterline	UV Stable
Theory	Y	Y	Y	Y	Y	Y	Y	Y	Y	Y	Y	N	Y	Y
Thread II	Y	Y	Y	Y	Y	Y	Y	Y	Y	Y	N	N	Y	Y
Toledo	Y	Y	Y	Y	N	N	N	Y	Y	N	N	N	N	Y
Trendz	Y	Y	Y	Y	Y	Y	Y	Y	Y	Y	Y	Y	Y	Y
Trovata II	Y	Y	Y	Y	Y	Y	Y	Y	Y	Y	Y	Y	Y	Y
Uddo	Y	Y	Y	Y	N	N	Y	Y	Y	N	N	N	N	Y
Unique	N	N	Y	Y	N	N	N	N	Y	N	N	N	N	N
Uptown	Y	Y	Y	Y	Y	Y	Y	Y	Y	Y	Y	Y	Y	Y
Vara	TIP	TIP	TIP	TIP	TIP	TIP	TIP	TIP	TIP	TIP	TIP	TIP	TIP	TIP
Velocity	Y	Y	Y	Y	N	Y	Y	Y	Y	Y	N	N	Y	Y
Venetian Pebbles	Y	Y	Y	Y	Y	Y	Y	Y	Y	Y	Y	Y	Y	Y
Vertigo	N	N	Y	Y	N	Y	Y	Y	Y	Y	N	N	N	Y
Virtue	Y	Y	Y	Y	Y	Y	Y	Y	Y	Y	Y	N	Y	Y
Volare	N	N	Y	Y	N	Y	N	Y	Y	Y	N	N	Y	Y
Waterlace	TIP	TIP	TIP	TIP	TIP	TIP	TIP	TIP	TIP	TIP	TIP	TIP	TIP	TIP
Xtra	Y	Y	Y	Y	Y	Y	Y	Y	Y	Y	Y	Y	Y	Y
Zen	N	N	Y	Y	N	Y	Y	Y	Y	Y	Y	N	Y	Y



Retro II™ Silver

BEST PRACTICES INSTALLATION

PREP:

PATTERN INSTALLATIONS

Before selecting a multi-size, multi-finish, or multi-product pattern, it is important to understand the nuances of pattern assembly and installation. Having the distribution center dry lay prior to ordering is absolutely necessary to ensure a pattern will work. Grout joint width must be taken into consideration in order for the final pattern design to align properly. Proper overages should be ordered to ensure the entire project is being ordered from appropriate size and shade calibers. When doing a checkerboard pattern, for example, with two tiles that are the same nominal size, from the same series, it may not work if the actual dimensions of the product are not the same. Each color, finish and size may be from a different production run. Selecting tiles from the same series or even the same color does not guarantee that a pattern will work correctly.

DRY LAY PRIOR TO SETTING IN MORTAR

It is standard practice to dry lay all tiles with a pattern as well as mosaic products, especially those with an interlock prior to setting them in mortar. This is especially critical with natural stones that may display V2 Shade variation or higher. Dry laying ensures the interlock is tight, the tiles can be blended properly and the sheet placement and cuts can be planned accordingly.

GAUGED PORCELAIN

It is important to understand gauged porcelain standards for interior installations (ANSI A108.19) prior to beginning any work. Special tools and procedures must be observed to ensure a successful install. There are many things to consider from transportation of A-frames on flat-bed trucks, A-frames to move materials around the jobsite, carrying material up elevators and stair wells, suction cups and special tools for handling, additional surface prep to ensure floor flatness, appropriate tables and tools for cutting, corner protectors, additional labor and the like. Emser Tile, in partnership with its adhesive manufacturers, offers training and information on how to achieve a successful installation in this product category prior to purchasing. As of the publication of this catalog there are no industry standards for exterior use. As such, manufacturer's recommendations prevail. A mortar method can be used for horizontal exterior applications, while a mortar and mortar/fastener method should be considered for vertical exterior applications.

SET:

FINISHING HIGH RELIEF EDGES

3D, textured, split-face and high relief products may be challenging to trim out when coming to a sudden stop in the middle of a wall, when tiling around an outlet, mitering a corner, or butting them up to an adjacent wall covering. Due to the nature of these products, it is best to tile from end to end both vertically and horizontally

whenever possible. Where a stop is necessary, some series may come with a flat field tile that can be used to trim out the desired edges. Otherwise, it may be necessary to simply leave the edge grouted, coordinate bullnose and flat pieces from other series, or install metal profiles. In the case of natural stone split faced edges, hand chiseling may be required. Additional options should be discussed and may be available prior to material specification.

KNOCKING DOWN RIDGES

Before pressing glass tiles and mosaics into adhesive, it is important to knock down the ridges and smooth them out with the flat edge of your trowel, to prevent them from showing through the glass lens, or coming up through thinner mosaic products. In some cases, where back buttering tiles is necessary, it is important these ridges be knocked down as well as not to create stripes or unintentional voids. For glass lens products, any mortar or adhesive that comes up between the tiles may be visible post install.

LEVELING CLIP SYSTEM

A leveling clip system is recommended to achieve narrow grout widths and minimize lippage with planks and large format tiles (those with a single edge being >18"). The clip system will not only allow for a tighter joint, but will minimize the visibility of any inherent warping, or lippage, that may be prevalent in the finished application. Often times a clip system will allow a joint to be narrower than the manufacturer's recommendation and should be discussed with a sales associate prior to specification.

LARGE FORMAT SHOWER FLOOR

Field tiles larger than 6"x6", that meet appropriate DCOF values based on final use, that cannot be sloped towards a center drain on a shower floor, may be sloped to one side using a linear drain. For proper sloping, reference to ANSI installation standards is required.

JOINT WIDTH

ANSI standards recommend that the actual grout joint size be at least three times the actual variation of facial dimensions of the tile supplied. Example: for tile having a total variation of 1/16" in facial dimensions, a minimum of 3/16" grout joint shall be used. Nominal centerline of all joints shall be straight with due allowances for hand molded or rustic tiles. The actual grout joint size may of necessity vary from the grout joint size specified or recommended by the manufacturer.

LIPPAGE ALLOWANCE

For grout joint widths 1/8"-1/4", a 1/32" lippage is allowed during installation. ANSI standards recommend that the total lippage be calculated by adding this allowable lippage for installation to the inherent warping of a product. Installation lippage + warping in manufacturing (within tolerance) = total allowable lippage of a finished assembly. This can be as much as the thickness of a quarter (coin), slightly over 2mm. The presence of lippage can be exaggerated by a number of factors: uneven subfloors, laying large

format tiles in a 50% brick joint offset, not back buttering large format tiles, grout joint width being too narrow and natural and artificial light sources making standard variances more noticeable. Industry standards allow for a certain amount of lippage to be present based on various factors. In backsplashes the most common unavoidable issue that accentuates lippage is under-cabinet lighting, lighting from a hood range washing the tiled wall. Whenever possible all light sources should be a minimum 24" from the wall to prevent shadowing.

UNIVERSAL COVE INSTALLATION

Emser Tile's cove bases are designed to be universal top mount, or inline, with a 3/8" radius to comply with health codes. To use the cove as a top mount, the bottom lip should be cut at the curvature to ensure the curve feathers into the floor it is being placed on top of. This would be most commonly used over existing tile or concrete floors. To be used as an in-line cove, the lip should remain intact and be installed adjacent to the floor tile (not on top of it), so the curvature feathers into the surface of the field tile. To comply with codes, the lip should never be placed on top of an existing floor covering creating a 90 degree angle between perpendicular surfaces. The lip either must be cut off, or sunken in behind the tile/floor. To tile above a universal covebase, the bullnose edge simply needs to be cut off. Alternatively, the top bullnose edge can be left in place when the cove is used as a base trim.

33% OFFSET

For running bond/brick joint patterns utilizing tiles (square or rectangular) where the side being offset is greater than 18" (nominal dimension), the running bond offset will be a maximum of 33% unless otherwise specified by the tile manufacturer. If an offset greater than 33% is specified, specifier and owner must approve mock-up and lippage. In some cases, tiles with an edge larger than 48", by necessity, may only accept a maximum 20% offset. Should tiles in the actual shipment received be completely flat, the final offset can be determined by the specifier and owner and can be 50% only if the tiles and substrates allow it. Some patterns such as a weave, pinwheel or herringbone are considered a 50% offset.

REMOVE AND REPLACE MODULES

When working with any mosaic sheet, especially those with a linear pattern, freeform pattern, or interlocking edge, manipulation by cutting individual modules from the mesh may be necessary to ensure that the product interlocks properly and creates a seamless look. Hand placement of individual pieces should also be considered for best results when working with certain types of freeform patterns to avoid small perimeter cuts.

PREVENTING CHATTER DURING GLASS CUTS

To avoid chipped edges when cutting with a wet saw, position the blade 1/32" short of cutting entirely through the glass. When the cut is complete, simply snap the edge off for the cleanest cut.

GROUT:

GROUTING HIGH RELIEF EDGES

Grouting high relief products may not be necessary in a dry application when the tile is just being used as a decorative wall covering. However, when using tiles in a wet application such as a shower, exterior, or any area that will come in contact with moisture, grease, food, or other types of debris, it may be necessary to grout in between the tiles to prevent water damage, mold growth and other undesirable effects. The best way to do this is with a grout bag and/or brush, to ensure the grout is forced into the joint properly. In some cases where the joint width is very narrow, caulking may be a more suitable option instead of grout.

BRUSHING DURING GROUTING

For the best results during grouting, a medium bristle brush may be required to expose the edge of the pebbles or high relief modules to a desired level and expose any that may have been buried using a standard rubber float.

FORCEFUL GROUTING AND SANDED GROUT

Forceful grouting with sanded and non-sanded grout may scratch the surface of metal, glass, resin, and polished finishes. It is important to be careful when grouting decorative mosaics, tiles with glossy glazes and unglazed polished products. A new rubber float is recommended for these types of finishes to ensure abrasives have not dried onto the float from any previous work.

CARE:

REMOVING NANO COATINGS

Nano coatings are buffed into the surface of polished products to increase luster and protect the tiles during shipping, handling and installation. This finish should not be removed unless it has been compromised during installation. A nano cleaning agent is necessary to evenly remove the coating. Other types of chemicals and detergents may not work if they are not specifically designed to be a nano scrub. A sealer should be applied to the surface after the nano coating is properly removed to aid in day to day cleaning.

Grout Release and Sealing Porcelain, Ceramic, Glass and Metal
When installing matte glazed, unglazed, metallic, textured, crackled, or high DCOF products (>0.50 DCOF wet), the use of a grout release is recommended prior to grouting. This includes frosted and matte finished glass tiles as well. Grout particles may become trapped in the surface pores on a microscopic level, or in the textured grooves of a product and inadvertently create a grout haze. Sometimes this haze can be invisible until it is exposed to dirt. Although glazed and high-density products are generally considered impervious, sealing these types of products after install will aid in day to day cleaning and help eliminate the appearance of fingerprints and other marks only seen under certain angles of



Raimondi® Clip Leveling System

light. Using in appropriate sealers and/or not following the sealing manufacturer's instructions may result in undesirable effects on the tile such as yellowing, or creating a gummy film. All guidelines must be followed prior to application.

OTHER:

WALL WASH LIGHTING

If wall wash lighting that is installed under cabinets, or on a range hood, is positioned closer than the recommended 24" from a wall, specifier and owner must approve a mock-up as well as any lippage effects. The nature of wall wash lighting that is installed too close to a wall surface is such that it may create undesirable and exaggerated shadowing on the tiled surface, making the appearance of tile that is otherwise produced and installed according to industry standards unattractive.

SHADOW EFFECT IN GLASS TILE

When using back painted glass tile and mosaic products, a shadowing effect may be inherent in the finished application, at the grout joints, when viewed at certain angles. This effect is due to a number of factors including mortar ridges showing through, inherent presence of glue on the edges of any mosaic modules, or grout not being forced into the joint properly. It is most noticeable when the mortar is a contrasting color to the grout as well as when light colored grouts are used. In order to blend the appearance of shadows between adjacent tile modules, it is best to tint the mortar to match the grout color, make sure edges of tiles are clean, knock down any trowel ridges, ensure the mortar is not coming up between the tiles and ensure grout joints are properly filled.

MOUNTING SHOWER DOORS/HARDWARE TO GLASS TILES

Glass tiles breaking after being drilled for fixtures is a very common issue, even when the installer does everything correctly, due to a

number of factors such as: tension in the glass from drilling, over-tightening screws, not using rubber washers etc. Glass tiles are generally not recommended behind any type of grab bars, shower doors or any fixtures that need to be drilled into. Where tile is used in this type of application cracks may not be evident immediately during, or after install and may appear at a later time. If a glass tile is used in this type of application, rubber washers, soft joints, drilling into the joint, hand tightening screws, and water jetting holes whenever possible are recommended for optimal results.

GENERAL INSTALLATION LIABILITY

Emser Tile will not be responsible for any materials damaged due to improper installation, installation defects or errors, misuse including negligence, and physical or chemical abuse to the surface of the tile. It is imperative that industry standards and guidelines for installations are followed. Refer to the TCNA Handbook, NTCA Handbook, ANSI, NSI and any other reputable industry sources for guidelines on proper installation as needed.



Euphoria™ • Ocean Arrow

NOTEWORTHY INDUSTRY STANDARDS

ANSI (American National Standards Institute) is the governing body in the tile industry when it comes to both the manufacturing and installation of tile. TCNA (Tile Council of North America) publishes an installation handbook that identifies proper ANSI methods of installation depending on the substrate and the actual scope of work, as well as proper ASTM (American Society for Testing & Materials) methods for product testing. NTCA (national Tile Contractors Association) also publishes annual “How To” and Troubleshooting guides for its members. These guidelines are in place to make sure that manufacturing tolerances are taken into consideration during installation. It is important to understand these standards so that expectations can be set regarding the appearance of both the tiles received and the finished work.

An inherent characteristic of all fired products is that they may bow, wedge and warp to a certain degree causing them to potentially vary in size from batch to batch. These variations in size and color are due to changes in moisture and thermal loads that alter the tiles during production. Batches of tile are identified and separated into lots by specific shade and caliber. To find how out of square, or warped the limits of a tile are, tolerances by product type can be referenced in ANSI A137 manufacturing standards. For installation guidance, the TCNA Handbook or ANSI A108 should be observed.

ANSI A108 Installation Standards are written to accommodate the size variations between tiles. Large format tiles, those having an edge larger than 18”, are more prone to dimensional variations due to their size. If ANSI A108 recommendations for installation are not followed, then the inherent dimensional variation of a tile may be much more noticeable. These standards are written to help ensure successful installation. Lippage will be prominent and grout joints may not line up properly if they are disregarded. Alterations to recommendations should only be made if the actual size variance between tiles and jobsite conditions allows them. Any alterations should be accompanied by a mock up and approval by the installer and end user.

*The standards listed below are current at the time this catalog was published. ANSI standards and ASTM test methods may be subject to various updates throughout the year.

ANSI A108.02, SECTION 4.3.8 GROUT JOINT SIZE:

To accommodate the range in facial dimensions of the tile supplied for a specific project, the actual grout joint size may, of necessity, vary from the grout joint size specified. The actual grout joint size shall be at least three times the actual variation of facial dimensions

of the tile supplied. Example: for tile having a total variation of 1/16” in facial dimensions, a minimum of 3/16” grout joint shall be used. Nominal centerline of all joints shall be straight with due allowances for hand-molded or rustic tiles. In no circumstance shall the grout joint be less than 1/16”.

ANSI A108.02, SECTION 4.3.8.1 RUNNING BOND/BRICK JOINT PATTERNS:

For running bond/brick joint patterns utilizing tiles (square or rectangular) with any side greater than 15”, the grout joint shall be, on average, a minimum of 1/8” wide for rectified tiles and, on average a minimum of 3/16” wide for calibrated (non-rectified) tiles. The grout joint width shall be increased over the minimum requirement by the amount of edge warpage on the longest edge of the actual tiles being installed. For example, for a rectified tile exhibiting 1/32” edge warpage on the longest edge, the minimum grout joint for a running bond/brick joint pattern will be 1/8” + 1/32” or 5/32”, on average. Of necessity, in any installation, some grout joints will be less and some more than the average minimum dimensions to accommodate the specific tiles being installed.

ANSI A108.02, SECTION 4.3.8.2 RUNNING BOND/BRICK JOINT OFFSET:

For running bond/brick joint patterns utilizing tiles (square or rectangular) where the side being offset is greater than 18” (nominal dimension), the running bond offset will be a maximum of 33% unless otherwise specified by the tile manufacturer. If an offset greater than 33% is specified, specifier and owner must approve mock-up and lippage. ANSI A108.02 Section 4.3.7 Lippage guidelines, explanation, and caution: Lippage refers to differences in elevation between edges of adjacent tile modules. These differences or perception thereof are influenced by many factors such as:

1. The allowable thickness variation of the tile modules in accordance with manufacturing standards.
2. The allowable warpage of the tile or stone modules.
3. The spacing or separation of each tile module, which would influence a gradual or abrupt change in elevation.
4. Angle of natural or manufactured light accentuating otherwise acceptable variance in modules.
5. Highly reflective surfaces of tile or stone modules accentuating otherwise acceptable variance in the modules.
6. Variations in the subfloor

The following chart is a guideline for identifying acceptable lippage – this number must be added to the actual warpage of the tile:

TILE TYPE	TILE SIZE	JOINT WIDTH	ALLOWABLE LIPPAGE
Glazed Wall/Mosaics	1x1 to 6x6	1/16 to 1/8	1/32
Quarry	6x6 to 8x8	1/4 or greater	1/16
Paver	All	1/8 to 1/4	1/32
Paver	All	1/4 or greater	1/16



BEST PRACTICES MANUFACTURING

MANUFACTURING TOLERANCES

An inherent characteristic of all fired products is that they may bow, wedge and warp, to a certain degree, causing them to potentially vary in size from batch to batch. Even with regulatory controls in place, these variations in size and color may be inevitable and are due to changes in moisture and thermal loads that alter the product during manufacturing. Batches of tile are identified and separated into lots by specific shade and caliber. Multiple shades and calibers of a single item are accepted within a certain range. To find out what the acceptable out of square and warping tolerance limits are, product types can be referenced in ANSI A137 manufacturing standards. For installation guidance, the TCNA Handbook or ANSI A108 should be observed as they are written with manufacturing tolerances in mind.

FACE PATTERN REPEAT

Although advancements in inkjet technology allow for an increased number of faces before a repeat, all boxes are packaged at random. A box of tile may not be comprised of all unique faces. You may have repeats in your final shipment depending on the square footages that were ordered. Specific face patterns cannot be sorted or requested prior to shipping.

SHADE LOT VARIATION / TRIM COORDINATION

All tiles, whether manufactured or natural stone, are from a particular caliber and shade lot. It is not uncommon for the specific lot your order came from to no longer be available as early as a few weeks after making your original purchase. Block availability from a natural stone quarry and/or the shade and caliber lots of manmade tiles from a particular production run at a factory may be different with each order. On occasion, matching lots may be available. However, it is important to always order appropriate overages for cuts, pattern layouts, and future repairs to ensure a proper match. Trim pieces are intended to coordinate but also may not be made from a matching size and shade caliber. A lot check is recommended when specific requirements must be met. In some cases, special order options may be available.

VARYING SIZE AND FINISH WITHIN A SERIES

Due to the inherent nature of all fired products, size calibers must be observed when ordering multiple tiles, from the same series, for a single application. Field tiles that are used together in a pattern, or ones that must line up with trim, need to be verified against actual dimensions, not nominal dimensions. When specific alignment or coordination of colors and finishes are required, specific lots

need to be checked by request to ensure compatibility between products, even if all components are assembled from a single series.

COUNTRY OF ORIGIN AND QUALITY

All tiles are intended to be produced according to the guidelines set forth by ANSI and NSI manufacturing tolerances, regardless of the country of origin. Country of origin will not necessarily play a role in product performance or quality. The quality and performance of a product are observed in the technical characteristics and lab test results of a series.

MARKINGS ON BACK OF TILE

Arrows and other markings on the back of a tile are not related to the installation or direction the tile should be installed in any way unless explicitly noted on the product packaging, marketing and/or manufacturer's instructions.

METALS

Many modern mosaics and field tiles are made from actual aluminum, stainless steel, metallic foil backing, or metallic glazes. Often times these metals can be adversely affected by weathering, heat and moisture. It is always important to double check usage to ensure your product will not fail in your intended application. Scratching, oxidation, discoloration from heat and chemicals, appearance of finger prints and water spots are not considered a defect, but a natural reaction expected of metals exposed to certain conditions.

CAST METAL TILES

Cast metal tiles contain real metal particles that are combined with polymers and cast into molds. Due to the presence of real metal in these tiles, they are not recommended for exterior applications that are exposed to the elements. Cast metal tile is suitable for interior and covered exterior walls only and is not recommended for floors. The use of a non-sanded grout is recommended as sanded grout may scratch and dull the finish. These tiles are not suitable for pools, or fountains, but may be used in showers and backsplashes as long as they are not exposed to any harsh chemicals or abrasive cleaning.

GLASS TILE TYPES

There are various styles of glass on the market today. "Back painted" is a general term that describes the color application process to what typically starts out as a clear slab of glass tile



and has color applied to the back surface. If you hold the back painted tile sideways, you can see right through the lens. Not all back painted glass tiles are the same; there are subtle differences in manufacturing that define where these tiles can or cannot be used. It is imperative that the glass tile is installed over the proper substrate. To avoid adversely affecting the color of glass tile, white mortar is required for all installations. As most glass has translucent properties, it is important to ensure adequate coverage of mortar by lightly back buttering the tiles. Some types of back painted or back foiled glass are not suitable for exterior or wet applications as the coloring is not designed to hold up to these types of conditions. Glass tiles with a frosted finish will generally not do well when exposed to pool chemicals. For these reasons, usage may be color specific within a series.

CRACKLED AND CRAZED CERAMIC FINISHES

Crackled and crazed finishes are considered a desired look, not a defect, in the glaze of certain tiles. The tiles may be used on wet area walls if properly sealed. They are not recommended for general use on floors and counters. Typically, products with these finishes will have potential size variations adding to the handmade and hand painted look. It is recommended that a grout release, or a sealer be applied to the crackled glaze prior to installation so the tile will not absorb any grout pigments, or installation related debris. After grouting, a penetrating sealer should be used to seal the surface of the tile. Abrasive cleaners should not be used with these types of products.

VOC'S

Certification is not needed to satisfy LEED® specifications with hard flooring surfaces. The test methodology specified in CA Department of Public Health Standard - Section 01350 is the same one used for the following certifications:

SCS/RFI FloorScore

SCS Indoor Advantage, Indoor Advantage Gold

AQSI/GEI Greenguard, Greenguard -Children & Schools

CRI Green Label, Green Label Plus

Due to the manufacturing process of all of our fired floor tiles, the temperatures that these tiles are produced at inherently eliminate the presence of any off-gassing and results in no detectable emissions of Volatile Organic Compounds (VOCs). As such, Emser's floor tiles perform better than the requirements of the FloorScore certification. Hard surface flooring products can contribute to gaining 1 POINT for low-emitting materials in

LEED® V4 rating systems. The credit definition is: "Mineral-based finish flooring products such as tile, masonry, terrazzo, and cut stone without integral organic-based coatings and sealants and unfinished/untreated solid wood flooring qualify for credit without any IAQ testing requirements". For this reason, it is assumed that ceramic and porcelain floor tiles are negligible sources of VOCs and are available for credit without any testing requirements.

TRANSPARENCY

Emser tile practices raw ingredient transparency which can be seen in HPD2.1 and SDS documents. Additional information can be found in our sustainability initiative on www.emser.com as well as in this catalog.

FLAME SPREAD CHARACTERISTICS

Flame spread is measured using ASTM E84 Standard Test Method for Surface Burning Characteristics of Building Materials, compliant to CBC Chapter 8 Section 803. This test will measure flame spread, fuel contributed, and smoke developed. It is intended for all building materials including everything from counters, fabrics and wall surfaces to cementitious substrates. However, the test method and the building codes do not apply to tiled surfaces. The test itself does not list tile as a required specimen for submission. The time temperature curve this test is conducted at will max out at around 1200 degrees Fahrenheit. Quarry tile, ceramic and porcelain products pass this test as far as fuel and flame spread go. Although, under actual use circumstances, smoke may be caused on the surface of the tile due to a number of outside factors i.e. sealers, cleaners, grease, surface debris etc., which are not a direct cause of the tile itself, but rather due to inherent presence of foreign materials on the surface. Because ASTM E84 is conducted in levels below 1200 degrees and our tiles are manufactured at temperatures greater than 2000 degrees Fahrenheit, the combustion and melting points of our tiles substantially exceed the testing threshold. ASTM E84 is a comparative test where the performance of the test specimen is compared with that of fiber-cement board and select grade red oak flooring, which have been established as 0 and 100, respectively. Testing of floor tiles is not required or a recommended industry practice as they will produce a result of Class A-0 due to their composition.

BEST PRACTICES

NATURAL STONE

NATURAL VARIATION

Variations in veining, fissures, pits, texture, color and shade are inherent characteristics of natural stones and will vary from tile to tile as well as from lot to lot, depending on the type of stone you select. There are various types of stones available on the market, the most popular being granite, marble, onyx, limestone, travertine and slate. Some species and colors are more consistent than others. Range samples can be provided by request prior to purchasing that represent the range of a product. A single showroom display may not accurately represent a stone's complete aesthetic qualities.

HAND SELECTION

Hand selecting natural stone tiles and mosaics is impractical and is generally not accepted industry wide. However, where a specific aesthetic value is desired, range samples can be requested to represent the current lot prior to purchasing. Aesthetic appearance can be a very subjective selection process when looking at individual tiles, so the range of the product must be accepted "as is". If any adjustments need to be made to a specific range, waste factors must be accounted for during this selection process. The tiles provided are intended to represent the coloring and finish of the final shipment. Sometimes the range of a stone can be captured in 3 tiles, while other stones may require >10 samples.

CROSS VEINING IN LINEAR PATTERNS

Parallel lines that are desirable in vein cut stones may have occasional perpendicular cross veining that cut across the linear pattern. This veining is a natural occurrence just like the other colors, shades, and veining characteristics of the stone and may present itself at random. Cross veining is not a crack and does not compromise the stability of the stone. Veining is not considered a defect of the product.

STONE GRADES

Marbles and other natural stones are categorized by soundness classifications and are rated A-D by the Natural Stone Institute. This is not necessarily a quality, performance, or product usage scale, but rather a classification for character consistency and stability. This detailed grading system takes the stone's natural characteristics into consideration to set proper expectations. All travertine for example, regardless of manufacturer or country of origin, and many common colors of marble, like Crema Marfil and other commodity stones are always a Class C due to the natural presence of veins, pits and fissures. Within this grade, some quarries will separate their stones into sub-categories by identifying products as "Premium", "Plus", "Classic", "Select" etc. based on their own criteria to distinguish aesthetic consistency between lots. The "Premium" selection from one factory and supplier will be different than that of another and a Class C stone will always be a Class C regardless of the subcategory (batch aesthetic consistency) it is given. Some C and D stones are manufactured with resin reinforced mesh backing, holes are filled with cement or epoxy fillers, and rods are used for stability. Veining and coloring can be

generally inconsistent and a desired feature between modules, and chipped edges may be engineered from epoxy. Some species of stone have more inconsistencies than others, however, this is not a defect of the stone. This soundness classification guide is not to be confused with seconds, or commercial grade stones that require a good deal of fabrication to be useable.

STONE TYPES

Emser Tile's website and marketing literature may not represent the true geological nature of the stones commonly referred to in the industry as marble, granite, limestone, travertine, onyx, slate, sandstone, quartzite, etc. The true geological nature of any stone may be verified by conducting a test through an independent bona fide laboratory.

TRAVERTINE FILL COLORS

Filler colors in a prefilled travertine can vary from batch to batch as the coloring is changed to coordinate with every production run. However, it may not be an exact match to the base color of the stone due to natural stone variations.

TRAVERTINE HOLE FORMATION

Air pockets and voids are present in the stone during its formation and are a desired characteristic of the stone. Some of these holes and voids may be present under a razor thin layer of surface rock. It is not uncommon for a travertine floor to reveal new holes in the first year after installation from standard pedestrian loads, fillers dislodging, movement of fixtures and furniture. New hole formation is not considered a defect of this particular stone. If desired, these new voids can be filled quickly and easily with grout, epoxy or equivalent synthetic fillers.

RUST, EFFLORESCENCE, DISCOLORATION AND TRANSFORMATION

Presence of excessive moisture may affect the look of your stone. Efflorescence is a concentration of salt minerals trapped in the stone that become visible, similar in appearance to chalk or foam, in hot and humid climates and wet applications when water passes through the stone taking traces of salt to the surface. Rust may also appear in certain stones that have metal minerals like iron present in the body. When these minerals react with water, the water will pass through the stone bringing the oxidized metals to the surface. This is especially visible in slate, as well as lighter colored stones. It is imperative that the stones be properly sealed before and after installation and proper water proofing membranes are used to minimize and/or prevent these occurrences from happening. Six-sided sealing may be recommended to prevent discoloration in certain applications.

USING LIGHT STONES ON SHOWER FLOORS

When using light colored stones on shower floors it is important to seal the product prior to installation, ensure all weep holes are kept open during installation and do not get clogged with mortar,

and proper waterproofing measures are taken. Even when installing these products correctly, many light stones have a tendency to rust or darken over time when used as a shower floor. Sometimes these affects are immediate and other times they can take years to surface. Stone discoloration from a reaction to excessive moisture is not a defect but a natural occurrence of the product.

SEALING GRANITE

As a general rule, it is important to seal any product that has any percentage of water absorption to protect the surface. This applies to natural stones including granite, however, the only stones that typically go unsealed are black granites. When used as countertops or in wet applications, sealed black granites are known to show water marks and rings when exposed to moisture, or acids for extended periods of time. These watermarks or etchings can be caused by a number of factors, the most common is a reaction of the sealer being exposed to water for prolonged periods. The other reason may be a reaction of the mineral on the surface of the stone to acids. When using dark stones in wet applications, proper sealing and waterproofing methods must be observed based on the scope of work.

STONE FOR EXTERIOR USE

Certain stones, especially most slates and travertine, are not rated for exteriors or wet applications. Although some may do well in warm dry regions, they may be compromised when used in wet freeze/thaw environments. Although you may see photos of these types of products used successfully around pool sand patios, they may not be suitable in all climates. When used in inappropriate climates they can sometimes be maintained with additional maintenance, however, may ultimately fail if not installed or maintained correctly. Some stones can swell when they absorb water and as a result may rust, become muddy, brittle or flake excessively. Quartzite, although it looks like slate, is a completely different rock and is

perfect for wet and exterior applications as well as freeze/thaw climates. It is not uncommon for stones that look similar to have completely opposite types of performance characteristics. For this reason, it is important to check manufacturer's recommendations prior to specification.

EPOXY MORTARS- ONYX, MARBLE, SANDSTONE

It is important to use epoxy based, solid setting adhesives and grouts when installing mesh, resin, epoxy or fiberglass backed stone to ensure proper adhesion. Stones requiring epoxy, even if they are not mesh backed include; green marbles, serpentine stone, black marbles and some sandstones. These stones will typically warp or discolor from exposure to moisture during the installation process when using a standard mortar.

MORTAR COLORS

Many light stones such as marble and limestone may react negatively to the ingredients contained in gray mortars. It is highly recommended to use white mortar on light stones and gray mortar for darker ones.

STONE LIPPAGE

The presence of lippage can be exaggerated by a number of factors: uneven subfloors, laying stone in a 50% brick joint offset, not back buttering large format tiles, grout joint width being too narrow and the lighting source making standard variances more noticeable through shadowing. Industry standards allow for a certain amount of lippage to be present based on various factors. To eliminate lippage altogether, some stones may be altered by grinding and refinishing the surface after install. This procedure is to be conducted by skilled professionals and is only possible on select stones and finishes.



CARE & MAINTENANCE

CLEANING GLAZED PORCELAIN & CERAMIC

Glazed porcelain and ceramic tiles are among the easiest flooring materials to clean. Due to their impenetrable glazes, their surfaces are resistant to water, dirt, chemicals, oil, debris, and even germs and bacteria.

Always remember:

- Do not clean porcelain tile flooring with ammonia or with cleaners that contain bleach and/or acid. Acid and ammonia based cleaners may modify grout color and product stability.
- Use a cleaner that is pH neutral. This ensures cleaning will not harm your grout or surrounding surfaces.
- Do not use wax or oil-based cleaners.
- Use rugs at entrances to prevent dirt and grit from being tracked onto the tile flooring from outdoors. Tiles are scratch resistant but not scratch proof.
- Do not use steel wool or other abrasive pads to remove tough debris or stains. Steel wool scratch your tiles and loose steel particles may eventually create rust stains in the grout over time.
- Although glazed surfaces are impervious, the use of a grout release will aid in post installation clean up, especially if the glazed surface has a texture to it where mortar, grout and other construction debris can get trapped inside grooves during and after installation.

Standard cleaning guidelines of glazed products:

- Sweep or vacuum loose dirt and dust from the floor prior to washing with water to prevent the tile from becoming muddy or leaving a residue after cleaning. On textured surfaces sweep in multiple directions to ensure the removal of all foreign material that might be residing in the textured surface. For wall surfaces tile can be gently wiped down with a clean, dry cloth or rag.
- Mop the floor with a mild detergent, degreaser, or tile cleaning solution. For textured floors, the use of a medium bristle brush is recommended. A sponge or clean cloth can be used to apply the cleaning agent to wall surfaces.
- Rinse the tile thoroughly with clean water to remove any left-over detergents.
- Drying with a clean cloth or rag is recommended to increase the shine and to prevent water spots or streaks.

CLEANING UNGLAZED PORCELAIN & CERAMIC

Unglazed products are highly desirable due to their double loaded and through-body characteristics. Polished finishes are typically protected by nano and/or wax coatings and are resistant to water, chemicals, and scratching. Matte and textured finishes are generally unprotected and although the surface is impervious, it

may be more difficult to clean post install than a polished surface due to the inherent surface characteristics of these finishes on a micro pore level.

Always remember:

- Do not clean porcelain tile flooring with ammonia or with cleaners that contain bleach and/or acid.
- Acid and ammonia based cleaners may modify grout color and product stability.
- Use a cleaner that is pH neutral. This ensures cleaning will not harm your grout or surrounding surfaces.
- Do not use wax or oil-based cleaners.
- Use rugs at entrances to prevent dirt and grit from being tracked onto the tile flooring from outdoors.
- Tiles are scratch resistant but not scratch proof.
- Do not use steel wool or other abrasive pads to remove tough debris or stains. Steel wool may scratch your tiles and loose steel particles may eventually create rust stains in the grout over time.
- Nano coatings should remain intact post install for added protection. However, if electing to remove nano coatings, a nano scrub or poultice type product may be used. Ask a sales associate for details.
- Although unglazed surfaces are impervious, the use of a grout release will aid in post install clean-up, especially if the unglazed surface has a matte or textured finish to it where construction debris can get trapped during grouting. Sealing may also be recommended post install to aid in day-to-day maintenance of these surfaces.
- It is suggested that a breathable penetrating sealer be applied to matte unglazed surfaces after grouting. This treatment provides an excellent defense against staining and may be desirable in high traffic areas. Follow the sealing manufacturer's guidelines for recommendations on how often a sealer should be reapplied.

Standard cleaning guidelines of unglazed products:

- Sweep or vacuum loose dirt and dust from the floor prior to washing with water to prevent the tile from becoming muddy or leaving a residue after cleaning. On textured surfaces sweep in multiple directions to ensure the removal of all foreign material that might be residing in the textured surface. For wall surfaces tile can be gently wiped down with a clean, dry cloth or rag.
- Mop the floor with a mild detergent, degreaser or tile cleaning solution. For textured floors, the use of a medium bristle brush is recommended. A sponge or clean cloth can be used to apply the cleaning agent to wall surfaces.

- Rinse the tile thoroughly with clean water to remove any left-over detergents.
- Drying with a clean cloth or rag is recommended to increase the shine and to prevent water spots or streaks.

CLEANING GLASS, METAL & DECORATIVE MOSAICS

Many of the metal tiles you see on the market today are made from solid metal, coated in metal glazes, or cast from polymers that are fused with real metal particles. Due to the presence of actual metal in most cases, careful attention must be paid when cleaning these unique surfaces. Glass is one of the easiest surfaces to clean. Due to its impervious nature, all stains will remain on the surface and can be wiped away with no effort. When cleaning glass and/or resin based blends the least abrasive method should always be used first as not to damage, discolor, or scratch the surface.

Always remember:

- Stainless steel cleaners for appliances tend to work well on stainless steel tiles as they are typically made from similar grades of steel. However, it is important to note that not all metal tiles are made from stainless steel and as such a pH neutral cleaner or water with a mild soap solution can be used.
- It is not recommended that any abrasive cleaners or scouring pads be used to clean metal as it may scratch the surface and cause the tiles to oxidize.
- It is also important to keep the tiles dry and away from heat as much as possible.
- Be sure to follow grout manufacturer's instructions on cleaning and sealing grout properly.
- Grout cleaners containing bleach or ammonia may be harmful to the metal if not applied properly.
- Do not use any abrasive cleaners or scouring pads to clean glass as they may scratch the surface.
- There are many cleaning solutions on the market today suitable for cleaning glass tile. In most cases a standard glass or multi-surface cleaner applied with a cloth or paper towels will work well.

Standard cleaning guidelines of glass, metal and decorative products:

- Wipe loose dirt or grease from the surface. An untreated paper towel or cloth is recommended.
- Wash the surface with a mild detergent, degreaser, or glass cleaning solution (do not use abrasive cleaners or abrasive applicators).
- Rinse the tile thoroughly with clean water if a detergent is used.
- Drying with a clean cloth or paper towel is recommended to increase the shine and to prevent water spots or streaks.

CLEANING NATURAL & ENGINEERED STONE

Natural stone is a very durable surface when protected and

maintained properly and is widely used in residential and commercial applications.

Always remember:

- Sweep or vacuum your floors regularly.
- Protect your stone from sand and grit as floors may scratch from dirt and debris.
- Be careful with acidic foods and drinks (lemonade, orange juice, etc.) as they may etch certain stones.
- Never use any cleaners that contain ammonia, acids, or bleach.
- Never apply wax or acrylics to the surface as they may damage the stone.
- Tend to spills quickly. Sealers do not prevent 100% of damages caused by spills.
- Sealing all natural stone is highly recommended.
- It is suggested that a breathable penetrating sealer be applied before and after grouting. This treatment provides an excellent defense against staining and may be desirable in high-traffic areas. Follow the sealing manufacturer's guidelines for recommendations on how often a sealer should be reapplied.

Standard cleaning guidelines for natural stone:

- Sweep or vacuum loose dirt and dust from the floor. For wall surfaces, tile can be gently wiped down with a clean, dry cloth or rag.
- Mop the floor with a mild detergent, degreaser, or tile cleaning solution. A sponge or clean cloth can be used to apply the cleaning agent to wall surfaces.
- Rinse the tile thoroughly with clean water to remove any left-over detergents.
- Drying with a clean cloth or rag is recommended to increase the shine and to prevent water spots or streaks.

COMMERCIAL DEEP CLEANING

Commercial cleaning can present its own challenges due to the high traffic nature of most applications and exposure to foreign debris that a standard residential application may not be subject to. Commercial floors must be maintained properly to ensure the longevity of an application.

Always remember:

In addition to following standard cleaning protocol for your product type, also consider the following:

- Floors need to be kept as dry as possible after cleaning to prevent slip accidents
- When mopping, the water should be changed frequently so you are not pushing around muddy water
- Scrubbing the floors too often with a buffer may cause irregular wear patterns
- Always be sure to protect furniture legs and stanchions with felt pads to protect the floors from scratching

CARE & MAINTENANCE (CONT.)

- Chewing gum, grease and other debris difficult to remove may require use of a plastic putty knife
- Prior to removing graffiti and other difficult stains, test a small area to make sure the chemical agents will not damage the surface.
- For embedded stains, the use of a poultice mix may be required
- When electing to remove nano coatings, a nano scrub or poultice type product may be used
- Prolonged use of bleach and ammonia based products may cause the grout to become brittle over time and in wet applications may result in water damage due to cracking and deterioration.
- Sealing grout prevents staining. Sealers are not chemical proof and may break down from continued exposure to harsh household chemical cleaners.
- It is suggested that a breathable penetrating sealer be applied before and after grouting. This treatment provides an excellent defense against staining, mold and mildew. Follow the sealing manufacturer's guidelines for recommendations on how often a sealer should be reapplied.

Standard deep cleaning guidelines:

- Sweep or vacuum loose dirt and dust from the floor. For wall surfaces, tile can be gently wiped down with a clean, dry cloth or rag.
- Mix a high concentration cleaner, degreaser, or stripper as needed based on manufacturer's guidelines for periodic deep cleaning.
- Agitate with scrub brush or floor scrub machine.
- Mop up dirty solution. A wet/dry vac may be used in large areas.
- Rinse thoroughly with clean water, changing water every 500 sq. ft. or as needed.
- Drying with a clean cloth or rag as well as a final dry vac extraction is recommended to increase the shine, prevent water spots and streaks, and to prevent slip accidents in a commercial setting.

CLEANING GROUT

There are many grouts on the market today that are stain resistant and do not require a sealer. However, not all grouts will have these characteristics and special care must be taken to ensure product performance is not compromised due to exposure to harsh cleaners.

Always remember:

- Clean tile and stone regularly according to standard cleaning guidelines. Anything safe for the tile will typically be safe for your grout. PH neutral cleaners are highly recommended. Mopping dirty tiles will cause muddy water to get stuck in the grout joints, so keeping tiles cleaned regularly will improve the look of the grout.
- Be careful with acidic foods, drinks and dyes as they may stain certain types of grout.
- Never use cleaners that contain ammonia, acids, or bleach. Some stains may be set so deep in the grout that bleach may be the only thing to get your grout clean. Bleaching causes the pores of the grout to open and hold dirt even more. As such, sealing after bleaching is highly recommended.

Standard cleaning guidelines for grout:

- Sweep, brush, or vacuum loose dirt and dust from the surface. For wall surfaces, grout can be gently wiped down with a clean, dry cloth or rag.
- Mop, brush, or sponge the surface with a mild detergent, degreaser, or tile cleaning solution.
- Rinse the grout thoroughly with clean water to remove any left-over detergents.
- Drying with a clean cloth or rag is recommended to prevent water spots or streaks on the tile.
- Reseal grout periodically as needed.

Pre and post grout install tips:

Using a grout release or sealer prior to installation is recommended especially for product that is porous or has a textured surface. Often times grout particles may become trapped and difficult to clean during the standard grouting process and the use of a rag or sponge may not pull up all the grout haze. Using a grout release and/or sealer will help prevent this from happening. Also important to note is that grout haze left on the surface of a tile will become difficult to remove and the chemicals needed to remove it at a later time may damage the tile or alter its looks. Heavy duty grout haze removers should be used according to the grout manufacturer's recommendations before trying more concentrated acid solutions.

WARRANTIES INFORMATION

ONE YEAR LIMITED WARRANTY AND LIMITATIONS ON LIABILITY

Emser Tile® offers a limited warranty on its products to the original purchaser, for one year from the date of purchase, to be free of manufacturing defects. Emser warrants only to its immediate customers and to no other person that its products will, on the date of ship, meet the foregoing terms of Emser's bid confirmation, order acknowledgement or sales order pursuant to which such products were sold. Tile and natural stone are subject to standard variances resulting from the manufacturing process or origin. Emser Tile® does not provide warranty on products that are within the industry standard variance levels.

DEFECTS & CLAIMS

In the event of a defect within any product distributed to the customer by Emser Tile®, the customer agrees to notify Emser immediately upon becoming aware of such defect. If a defect in manufacturing or coloring is identified in advance of installation, the customer agrees to not install any defective product without the written agreement of Emser Tile®.

Emser Tile® reserves the right to inspect any and all defects prior to any repair, remediation or settlement of such defect. In the event that Emser Tile® is required to participate in the repair, remediation or settlement of any defect, Emser must be included in all discussions and decisions related to such repair, remediation and/or settlement. In the event that the customer fails to notify Emser on a timely basis, or fails to allow Emser the right of inspection, discussion or decision making in advance of repair, remediation or settlement of any defect, the customer agrees to release Emser Tile® from any liability for the defect or claim. Customer misuse including negligence, physical or chemical abuse is not covered by this warranty. Improper installation, installation defects or errors are not covered by this warranty. Warranty claims must be submitted in within 30 days upon discovery of the proposed defect.

NATURAL STONES

Emser Tile®'s website and marketing literature may not represent the true geological nature of the stones commonly referred to in the industry as marble, granite, limestone, travertine, onyx, slate, sandstone, quartzite, etc. The true geological nature of any stone may be verified by conducting a test through an independent bona fide laboratory.

TOOLS & SUPPLIES



Prep

- Floor Prep and Leveling
- Moisture Mitigation
- Tile Backerboard
- Lath and Wire
- Crack Isolation & Sound Control
- Waterproofing Membranes

Set

- Polymer Modified Large Format Tile & Stone and Thinset Mortars
- Rapid Setting Mortars
- Thick Bed Mortars
- Stone Veneer Installation Systems
- Outdoor Paver Solutions

Grout

- Sanded and Non-Sanded Grout
- High Performance Grout
- Epoxy and Industrial Grade Epoxy Grout
- Ready To Use Grout
- Single Component High-Performance Grout
- Specialty Designer Series Grouts and Limited Edition Offerings

Care

- Impregnating Sealers
- Cleaners & Resealers
- Problem Solvers
- Restoration and Colorants
- Anti-Slip Coatings

Accessory Categories

- Lippage Prevention Systems for installing Large Format Tiles and achieving perfectly Flat Floors
- Shower System Solutions that save you time and labor
- Full line of tools to complete the job from demo work to installation
- Floor Heating Systems
- Metal and PVC Profile Solutions
- Floor Protection Products for all hard surfaces and carpet to prevent damage to newly installed work
- Full Line of PPE - Respirators, Protective Eye wear, Hearing Protection, Gloves, and more

Emser Tile® offers trainings for our professional customers – in-person at our locations, virtually, and in conjunction with our Supplier Partners at their facilities. Talk to your local Emser Sales Representative about upcoming trainings in your market.



BB Concrete • Black | Signature Series™ Profiles



SALES & SERVICE LOCATIONS

CORPORATE HEADQUARTERS

EMSER CORPORATE OFFICE

8431 Santa Monica Blvd.
Los Angeles, CA 90069
Ph: 323-650-2000 | Fax: 323-654-3190

DISTRIBUTION CENTERS

WESTERN DISTRIBUTION CENTER

5300 Shea Center Drive
Ontario, CA 91761
Ph: 909-974-1600 | Fax: 909-974-1690

EASTERN DISTRIBUTION CENTER

1020 Centerpoint Drive
Suffolk, VA 23434
Ph: 757-935-4060 | Fax: 757-935-4050

CENTRAL DISTRIBUTION CENTER

10433 Ella Boulevard
Houston, TX 77038
Ph: 713-462-2411 | Fax: 713-460-9497

FLORIDA DISTRIBUTION CENTER

4030 NW 126th Avenue
Coral Springs, FL 33076
Ph: 954-507-8011

ALABAMA

BIRMINGHAM
288 Oxmoor Court, Suite B
Birmingham, AL 35209
Ph: 205-945-1500
Fax: 205-945-1510
birmingham@emser.com

ARIZONA

GLENDALE
5255 W. Phelps Road, Suite 3
Glendale, AZ 85306
Ph: 602-866-8453
Fax: 602-896-8453
glendale@emser.com

PHOENIX
2604 South 38th Street
Phoenix, AZ 85034
Ph: 602-263-8453
Fax: 602-431-9444
phoenix@emser.com

SCOTTSDALE
15500 N. Greenway-Hayden Loop,
Suite 1
Scottsdale, AZ 85260
Ph: 480-443-8453
Fax: 480-443-8467
scottsdale@emser.com

TUCSON
2430 N. Flowing Wells Road
Tucson, AZ 85705
Ph: 520-623-7727
Fax: 520-623-7850
tucson@emser.com

ARKANSAS

LITTLE ROCK
10068 Maumelle Blvd.
Little Rock, AR 72113
Ph: 501-771-9111
Fax: 501-771-9311
littlerock@emser.com

CALIFORNIA

ANAHEIM
1400 S. State College Blvd.
Anaheim, CA 92806
Ph: 714-778-5777
Fax: 714-778-1572
anaheim@emser.com

BAKERSFIELD
4525 Stine Road
Bakersfield, CA 93313
Ph: 661-837-4400
Fax: 661-837-4401
bakersfield@emser.com

CHATSWORTH
9210 De Soto Avenue
Chatsworth, CA 91311
Ph: 818-718-2933
Fax: 818-718-6947
chatsworth@emser.com

CORONA
525 Cardiff Street
Corona, CA 92879
Ph: 951-372-8453
Fax: 951-372-9670
corona@emser.com

FAIRFIELD
815 Chadbourne Rd., Suite 140
Fairfield, CA 94534
Ph: 707-435-8453
Fax: 707-425-6898
fairfield@emser.com

FRESNO
5650 E. Clinton
Fresno, CA 93727
Ph: 559-291-8453
Fax: 559-291-1966
fresno@emser.com

LOS ANGELES
8431 Santa Monica Boulevard
Los Angeles, CA 90069
Ph: 323-650-2010
Fax: 323-650-1589
losangeles@emser.com

MODESTO
4459 Spyres Way, Suite H
Modesto, CA 95356
Ph: 209-527-8453
Fax: 209-527-8464
modesto@emser.com

PALM DESERT
77-588 El Duna Court
Palm Desert, CA 92211
Ph: 760-834-2095
Fax: 760-834-2096
palmdesert@emser.com

SACRAMENTO
9819 Business Park Drive, #1
Sacramento, CA 95827
Ph: 916-361-1900
Fax: 916-361-0360
sacramento@emser.com

SALINAS
3 Rossi Circle, Unit E & F
Salinas, CA 93907
Ph: 831-757-8453
Fax: 831-757-7528
salinas@emser.com

SAN DIEGO
6350 A Miramar Road
San Diego, CA 92121
Ph: 858-455-6390
Fax: 858-455-8278
sandiego@emser.com

SAN JOSE
2109 Bering Drive
San Jose, CA 95131
Ph: 408-954-8453
Fax: 408-954-8456
sanjose@emser.com

SAN LEANDRO
1489 Doolittle Drive
San Leandro, CA 94577
Ph: 510-635-3800
Fax: 510-635-3885
sanleandro@emser.com

SAN MARCOS
1040 Los Vallecitos Boulevard Unit 111
San Marcos, CA 92069
Ph: 760-510-8333
Fax: 760-510-8390
sanmarcos@emser.com

SANTA ROSA
237 Todd Road, Suite 101
Santa Rosa, CA 95407
Ph: 707-584-3800
Fax: 707-584-3900
santarosa@emser.com

TEMECULA
42092 Winchester Road, Suite A
Temecula, CA 92590
Ph: 951-296-3671
Fax: 951-296-3675
temecula@emser.com

COLORADO

COLORADO SPRINGS
4618 Northpark Drive
Colorado Springs, CO 80918
Ph: 719-264-8453
Fax: 719-264-8470
coloradosprings@emser.com



Emser Tile® Florida Distribution Center

DENVER

3650 Fraser Street, Unit B
Aurora, CO 80011
Ph: 303-975-9400
Fax: 303-975-9009
denver@emser.com

FLORIDA

FORT MYERS, FL
12014 Metro Parkway
Fort Myers, FL 33966
Ph: 239-318-6350
Fax: 239-245-7845
fortmyers@emser.com

JACKSONVILLE

9450 Phillips Highway, Suite 4
Jacksonville, FL 32256
Ph: 904-260-6336
Fax: 904-260-8949
jacksonville@emser.com

MIAMI

8400 NW 25th Street,
Suite # 128
Doral, FL 33122
Ph: 786-482-7000
Fax: 305-718-6697
miami@emser.com

ORLANDO

2420 Lynx Lane, Suite B
Orlando, FL 32804-4722
Ph: 407-720-7090
Fax: 407-720-7098
orlando@emser.com

POMPANO BEACH

3308 Park Central Blvd. North
Pompano Beach, FL 33064
Ph: 754-220-7480
Fax: 754-220-7481
pompanobeach@emser.com

TAMPA

7725 Anderson Road
Tampa, FL 33634
Ph: 813-947-7080
Fax: 813-243-2354
tampa@emser.com

GEORGIA

ATLANTA
5470 Oakbrook Parkway
Norcross, GA 30093
Ph: 770-840-9980
Fax: 770-840-9498
atlanta@emser.com

ATLANTA-WEST

250 Hembree Park Drive,
Unit 118
Roswell, GA 30076
Ph: 678-893-6850
Fax: 678-935-3977
atlanta@emser.com

IDAHO

BOISE
12050 W. Franklin Road
Boise, ID 83709
Ph: 208-375-2020
Fax: 208-375-2072
boise@emser.com

ILLINOIS

CHICAGO
880 Devon Avenue,
 Bensenville, IL 60106
Ph: 847-957-8270
Fax: 630-521-0216
chicago@emser.com

BOLINGBROOK

100 East Crossroads Pkwy,
Unit A,
Bolingbrook, IL 60440
Ph: 331-318-3400
Fax: 331-318-3401
bolingbrook@emser.com

INDIANA

INDIANAPOLIS
8700 Roberts Drive, # 100
Fishers, IN 46037
Ph: 317-576-4740
Fax: 317-576-4741
indianapolis@emser.com

KANSAS

KANSAS CITY
10550 Lackman Road
Lenexa, KS 66219
Ph: 913-894-4888
Fax: 913-894-4887
kansas@emser.com

WICHITA

2333 S. West Street,
Suite 301
Wichita, KS 67213
Ph: 316-943-1441
Fax: 316-943-1445
wichita@emser.com

KENTUCKY

LOUISVILLE
3322 Gilmore Industrial Blvd.
Louisville, KY 40213
Ph: 502-962-7255
Fax: 502-962-7259
louisville@emser.com

LOUISIANA

NEW ORLEANS
5445 Powell Street
New Orleans, LA 70123
Ph: 504-818-2050
Fax: 504-818-1366
neworleans@emser.com

MARYLAND

BALTIMORE
7447 New Ridge Road
Hanover, MD 21076
Ph: 410-595-2100
Fax: 410-595-2095
baltimore@emser.com

FREDERICK

4660 New Design Road
Frederick, MD 21703
Ph: 240-651-2918
Fax: 301-732-5768
frederick@emser.com

MINNESOTA

MINNEAPOLIS
14105 13th Ave. North, Suite C
Plymouth, MN 55441
Ph: 763-251-1670
Fax: 763-251-1671
minneapolis@emser.com

MICHIGAN

DETROIT
7081 19 Mile Road
Sterling Heights, MI 48314
Ph: 586-930-7045
Fax: 586-739-1950
detroit@emser.com

SALES & SERVICE LOCATIONS (CONT.)

NEBRASKA

OMAHA
11941 Centennial Road, Suite 6
La Vista, NE 68128
Ph: 402-339-8453
Fax: 402-339-1772
omaha@emser.com

NEVADA

LAS VEGAS
3655 W. Sunset Road, Suite A
Las Vegas, NV 89118
Phone: 702-795-8453
Fax - 702-795-8479
lasvegas@emser.com

RENO

280 Greg Street, Suite 14
Reno, NV 89502
Ph: 775-786-1222
Fax: 775-786-3880
reno@emser.com

NEW JERSEY

LYNDHURST
1270 Valley Brook Ave.
Lyndhurst, NJ 07071
Ph: 201-514-7778
Fax: 201-993-0718
lyndhurst@emser.com

NEW MEXICO

ALBUQUERQUE
8520 Pan American Freeway NE, Unit B
Albuquerque, NM 87113
Ph: 505-821-2110
Fax: 505-821-8861
albuquerque@emser.com

NORTH CAROLINA

CHARLOTTE
11325 Nations Ford Rd, Suite J
Pineville, NC 28134
Ph: 704-504-5288
Fax: 704-504-5299
charlotte@emser.com

RALEIGH

409-A Airport Blvd., Suite 100
Morrisville, NC 27560-8426
Ph: 919-650-6280
Fax: 919-882-8619
raleigh@emser.com

OHIO

CINCINNATI
5651 Union Centre Dr.
West Chester, OH 45069
Ph: 513-866-4107
Fax: 513-401-5936
cincinnati@emser.com

CLEVELAND

850 Resource Drive, Suite 1
Brooklyn Heights, OH 44131
Ph: 216-505-9393
Fax: 216-505-9394
cleveland@emser.com

COLUMBUS

660 Dearborn Park Lane
Worthington, OH 43085
Ph: 614-681-7143
Fax: 614-781-8891
columbus@emser.com

OKLAHOMA

OKLAHOMA CITY
4015 S. Purdue Street, Suite B
Oklahoma City, OK 73179
Ph: 405-848-2292
Fax: 405-848-2970
oklahoma@emser.com

TULSA

5024 S. Mingo Road, Suite A
Tulsa, OK 74145
Ph: 918-663-8453
Fax: 918-663-8454
tulsa@emser.com

OREGON

EUGENE
191 Seneca Road, Suite A
Eugene, OR 97402
Ph: 541-434-8453
Fax: 541-434-8454
eugene@emser.com

PORTLAND

4338 N.W. Yeon Avenue
Portland, OR 97210
Ph: 503-224-5056
Fax: 503-224-0089
portland@emser.com

PENNSYLVANIA

PHILADELPHIA
150 Green Tree Rd., Suite 1003
Oaks, PA 19456
Ph: 610-947-1157
Fax: 610-482-9373
philadelphia@emser.com

SOUTH CAROLINA

CHARLESTON
8351 Palmetto Commerce Pkwy
Unit 106B
Ladson, SC 29456
Ph: 843-203-7315
Fax: 843-873-1018
charleston@emser.com

TENNESSEE

MEMPHIS
5628 Distribution Dr., Suite 108
Memphis, TN 38141
Ph: 901-797-9300
Fax: 901-797-9230
memphis@emser.com

NASHVILLE

2505 Bransford Ave
Nashville, TN 37204
Ph: 615-297-9299
Fax: 615-297-9295
nashville@emser.com

TEXAS

AUSTIN
2315 Rutland Dr., Suite 101
Austin, TX 78758
Ph: 512-835-2888
Fax: 512-973-8898
austin@emser.com

DALLAS

11639 Emerald Street, #200
Dallas, TX 75229
Ph: 972-241-7400
Fax: 972-241-7436
dallas@emser.com

EL PASO

11355 Rojas Drive, Unit 1-4
El Paso, TX 79936
Ph: 915-633-9988
Fax: 915-629-9317
elpaso@emser.com

FORT WORTH

6314 Airport Freeway, Suite A
Fort Worth, TX 76117
Ph: 817-834-5200
Fax: 817-834-5210
fortworth@emser.com

HOUSTON

11850 Hempstead Highway,
Suite 195
Houston, TX 77092
Ph: 713-686-8404
Fax: 713-686-8303
houston@emser.com

HOUSTON NORTH

600 Spring Hill Drive, Suite 100
Spring, TX 77386
Ph: 281-292-1378
Fax: 281-292-5127
houstonnorth@emser.com

HOUSTON SOUTHEAST

12850 Fuqua Street, Suite 100,
Houston, TX 77034
Ph: 346-203-9170
Fax: 281-481-0284
hsehouston@emser.com

HOUSTON SOUTHWEST

10631 S. Sam Houston Parkway W.
Building 2
Houston, TX 77071
Ph: 281-564-9494
Fax: 281-561-5919
hswHouston@emser.com

MCALLEN

1201 N. Jackson Road, Suite 400
McAllen, TX 78501
Ph: 956-971-8453
Fax: 956-971-8454
mcalLEN@emser.com

SAN ANTONIO

1111 Arion Parkway, Suite 102
San Antonio, TX 78216
Ph: 210-402-3013
Fax: 210-402-3958
sanantonio@emser.com

UTAH

SALT LAKE CITY
3140 South 300 West
Salt Lake City, UT 84115
Ph: 801-474-9400
Fax: 801-474-9484
saltlakecity@emser.com

VIRGINIA

NORTH VIRGINIA
44970 Falcon Place, Suite 700
Sterling, VA 20166-9537
Ph: 703-870-2340
Fax: 703-870-2345
northernvirginia@emser.com

WASHINGTON

SEATTLE
18401 Cascade Avenue South
Building 300
Tukwila, WA 98188
Ph: 425-291-9449
Fax: 425-291-9319
seattle@emser.com

SPOKANE

4630 E. Sprague Avenue
Spokane, WA 99212
Ph: 509-535-8453
Fax: 509-535-7036
spokane@emser.com



Emser
TILE



8431 Santa Monica Boulevard | Los Angeles, California 90069
Tel: 323. 650. 2000 | Fax: 323. 654. 3190 | www.emser.com

